

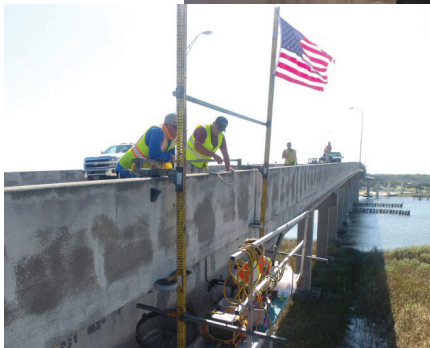

UNDERGROUND CONDUIT SUPPORT SYSTEMS

ENGINEERED TO ORDER

! Additional information available at www.CONDUX.com

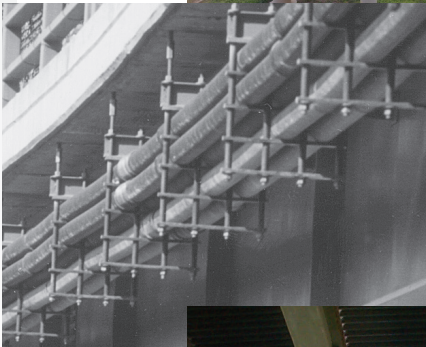

Condux Underbridge Conduit Support Systems

Condux is the world's leading designer and manufacturer of conduit bridge hanger systems. Our expertise spans a complete range of bridge sizes and designs—from the famous Golden Gate bridge in San Francisco to Tampa Bay's spectacular Sunshine Skyway bridge to a large number of smaller bridges all across the world.

Through that **experience**, we can help you with any special design problems you may encounter, and do it in a timely and cost effective manner.

We specialize in **personalized service**, providing you with all of the information and technical assistance you need to get you through every step of your bridge hanger project. As a basic part of our service, when you place an order with us we will assist you with a materials list and a system design layout. We also feature computerized design and estimation for rapid turnaround.

Condux support hanger hardware is manufactured from stainless steel or hot rolled material that has a **hot dip galvanized** coating that meets D.O.T. specification requirements.

The **fiberglass cross members** are manufactured fiberglass reinforced plastic material that is one of the strongest and most durable materials in the world. When you combine these two materials you have one of the strongest and corrosion resistant conduit support hangers available on the market which is supplied by Condux International.

All types of **conduit** (fiberglass, PVC, or steel) are available from Condux, to provide a complete Underbridge Conduit System. No matter what stage of the project you are in, Condux can help you in the most cost effective manner.

The Condux Underbridge Conduit Support Systems & Bore Spacers **Catalog and Design Guide** will provide you with complete information on designing and ordering bridge hanger systems. It is available through our web site at www.condux.com or by contacting Condux Customer Service at 1-800-533-2077.

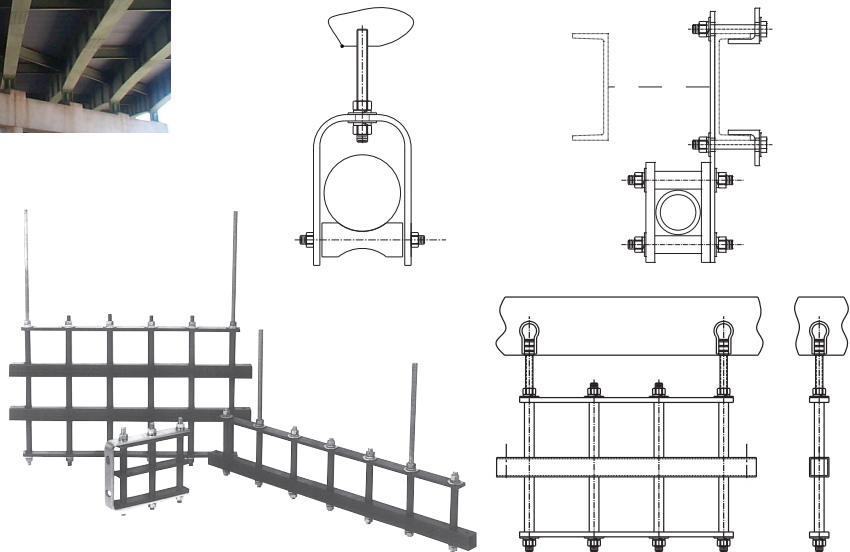



Condux Bore & Open Trench Spacers

Encasing underground conduit inside of steel pipe casings or in open trench spacers is a common preferred method of underground installation. It offers the maximum amount of security for underground cable, effectively eliminating many of the problems that can occur with underground installation. This method is gaining recognition as "The Right Way" to install underground cable. One of the factors that make such an installation work is the proper design of the spacers that align and hold the conduit true inside the pipe casing or open trench. Proper engineering of these spacers is critical to the reliability and longevity of the system.

Condux International is one of the largest producers of bore spacers and trench spacers in the United States. We have the experience and engineering expertise to assure the quality of your spacers. Condux spacers provide the following significant benefits:

Optimum Design—In many instances, the use of well-designed bore spacers will allow the use of a smaller casing for the same number of conduits. The savings from the price of the casing and the installation may balance the cost of the bore spacers, essentially making the bore spacers "free", while improving the ease of installation.

The use of open trench spacers allows for safe and easy assembly of the duct bank above ground before lowering it into the trench. This reduces the installation cost by allowing use of smaller trenches as no extra room is required to keep workers safe from the potential of trench walls caving in.

Waterjet Technology—Utilizing computer aided design, the waterjet process is used to produce a cleaner, more accurate spacer for less cost and reduced manufacturing time.

Flexibility—Virtually any configuration of conduits and grout holes can be quickly manufactured.

Rapid Turnaround—In most cases custom designed spacers are ready for shipment in 2 to 3 weeks.

Ease of Use—Bore spacers can be equipped with optional casters making the installation process smooth and easy. Open trench spacers can be ordered with or without feet.

The Condux Underbridge Conduit Support Systems & Spacers **Catalog and Design Guide** will provide you with complete information on ordering spacers. Call the toll-free number listed at the bottom of this page to order your copy, or visit our web site at www.condux.com.

For inquiries, contact Customer Service at 1-800-533-2077 or conduxinfo@condux.com with the following application information:

Bore Spacer Application Information:

- Casing I.D.
- Conduit O.D.
- Number of conduits
- Length of run
- Number of grout holes required
- Diameter of grout holes
- Minimum separation between conduits
- Conduit & grout hole configuration, and if casters will be required
- Sketch of spacer
- Quantity required

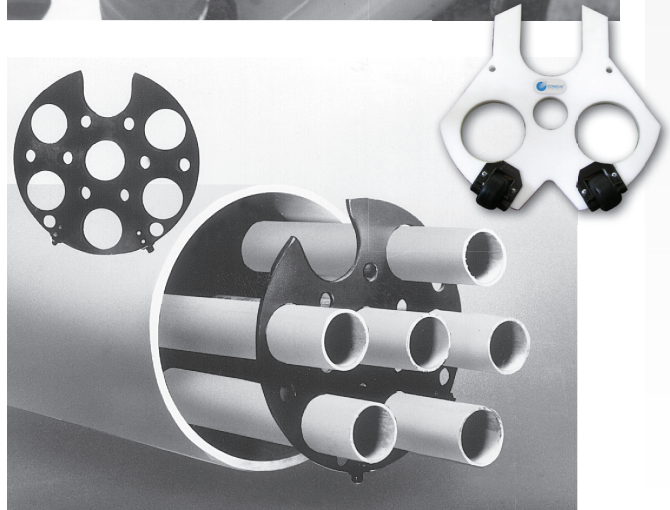

Open Trench Spacer Application Information:

- Conduit size
- Number of conduit high
- Number of conduit wide
- Minimum separation between conduits
- Length of run
- Sketch of spacer
- Quantity required

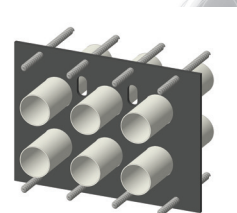



SINGLE ROLLER CABLE BLOCKS



Single Roller Cable Block

Support a single coaxial, fiber optic or copper cable or aerial innerduct up to 2.75" (70 mm) outside diameter with Condux Single Roller Cable Blocks. A built-in strand lock fits up to 3/8" (10 mm) strand to prevent creeping. The lock releases when struck by a Cable Block Pusher ahead of a Cable Lasher. Frames are durable cast aluminum. Rollers are constructed from cast aluminum.

See page 7 for replacement roller information.

Part Number	Description	Max Cable OD	Frame Material	Roller Material
18000670	Single roller cable block	2.75" (70 mm)	aluminum	aluminum
18501186	Aluminum Replacement Roller			

Pole Mount Single Roller Cable Block



The Pole Mount Single Roller Cable Block is specially designed for easy mounting and free-rolling required in figure-eight cable construction. Quickly mounts to a 3-bolt strand clamp on a pole and allows pulling from pole to pole. Support a single coaxial, fiber optic or copper cable or aerial innerduct up to 2.75" (70 mm) outside diameter. Steel frame, with plastic rollers.

Pole Mount Single Roller Cable Blocks are equipped with a steel cable retainer to keep the cable or innerduct on the roller, even in low-tension situations.

Max Strand Diameter 3/8" (10 mm)

See page 7 for replacement roller information.

Part Number	Description	Max Cable OD	Frame Material	Roller Material
18000620	Single roller cable block with cable retainer (plastic)	2.75" (70 mm)	steel	plastic
18501008	Plastic Replacement Roller			



REPLACEMENT ROLLERS



Replacement Rollers

Replacement Rollers available for aerial cable blocks and hangers. Refer to this chart for specifications on roller sizes.

! Due to heat generated by poly-blend rope during pulling operations, an aluminum roller should be utilized. With cotton ropes or pull tape, plastic rollers are adequate.

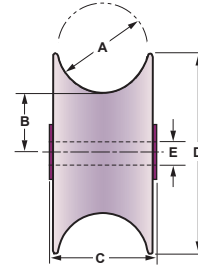

Part Number	Nominal Roller Size		Roller Material (Color)	Max Cable O.D. (A)		Min. Bending Radius (B)		Max. Roller Width (C)		Max Roller O.D. (D)		Shaft Diameter (E)	
	(IN)	(MM)		(IN)	(MM)	(IN)	(MM)	(IN)	(MM)	(IN)	(MM)	(IN)	(MM)
18501010	1.00 x 2.25	25x57	Plastic (Red)	1.00	25	0.31	8	1.50	38	2.25	57	0.38	10
18501044	1.25 x 2.25	32x57	Plastic (Black)	1.25	32	0.32	8	1.82	46	2.25	57	0.38	10
18403066	2.75 x 2.25	70x57	Rubber (Black)	2.50	63	0.32	8	1.82	46	2.25	57	0.38	10
18501008	2.75 x 4.62	70x117	Plastic (Blue)	2.75	70	1.05	27	3.44	87	4.63	117	0.50	13
18501186	2.75 x 4.62	70x117	Aluminum	2.75	70	1.05	27	3.44	87	4.63	117	0.50	13
18501043	1.00 x 1.25	25x32	Stainless Steel	1.00	25	0.32	8	1.50	38	1.25	3.2	0.38	10
18403067	2.75 x 1.25	70x32	Aluminum	2.50	63	0.32	8	1.90	48	1.25	32	0.38	10

Roller Size inches (mm)	Roller Material (Color)	Roller Part Number	PRODUCT					90° Corner Block
			Single Roller Cable Block	Single Mount Single Roller Cable Block	Economy Cable Block	Overlash Cable Block	Economy Overlash Cable Block	
1.00 x 2.25 (25 x 57)	plastic (red)	18501010					18151500	
1.25 x 2.25 (32 x 57)	plastic (black)	18501044			18401060			18101940
2.75 x 2.25 (70 x 57)	rubber (black)	18403066				18403060		
2.75 x 4.62 (70 x 117)	plastic (blue)	18501008		18000620				18101930
2.75 x 4.62 (70 x 117)	aluminum	18501186	18000670	18000625				18101935
1.00 x 1.25 (25 x 32)	stainless steel	18501043					18151600	
2.75 x 1.25 (70 x 32)	aluminum	18403067				18401180		





OVERLASH & ECONOMY CABLE BLOCKS

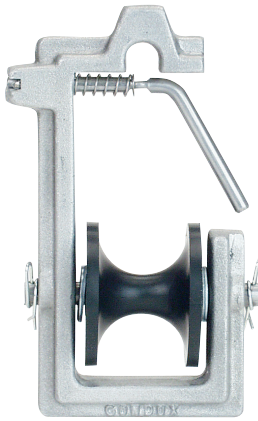

Cable Block 18401060

Economy Cable Block

Condux offers Economy Cable Blocks for support of one cable or innerduct up to 1.25" (32 mm) outside diameter. This block has a built-in strand retention with spring-loaded arm. Frames are durable cast aluminum with steel inserts on strand contact surfaces, and can be used on strands up to 3/8" (10 mm) in diameter. Rollers are plastic.

Replacement rollers available. See page 7 for ordering information.

Part Number	Description	Max Cable OD	Frame Material	Roller Material
18401060	Economy cable block, single	1.25" (32 mm)	aluminum	plastic
18501044	Plastic Replacement Roller			

! PRIOR TO ORDERING, ALWAYS KNOW THE FOLLOWING:

- Max Cable O.D. 1.25" (32 mm)
- Max Strand O.D. 3/8"(10 mm)
- Blocks Do Not Lock on Strand



Cable Block 18403060

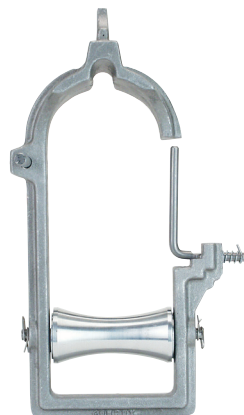

Cable Block 18401180

Overlash Cable Block

Fit Overlash Cable Blocks over an existing cable bundle up to 2.75" (70 mm) in diameter and support one 1.25" (32 mm) diameter cable or innerduct. Built-in cable retention system allows placement and removal from ground. Frames are durable cast aluminum with steel inserts on strand contact surfaces. Rollers are rubber or aluminum.

Part Number	Description	Max Cable Diameter		Frame Material	Roller Material
		(in)	(mm)		
18403060	Overlash cable block with 1 single roller	1.25	32	aluminum	rubber
18401180	Overlash cable block with 1 double roller	1.25	32	aluminum	aluminum
18403066	Rubber Replacement Roller				
18403067	Aluminum Replacement Roller				

! PRIOR TO ORDERING, ALWAYS KNOW THE FOLLOWING:

- Max Cable O.D. 1.25" (32 mm)
- Max Bundled O.D. 2.75" (70 mm)
- Blocks Do Not Lock on Strand

Due to heat generated by poly-blend rope during pulling operations, an aluminum roller should be utilized. With cotton ropes or pull tape, plastic rollers are adequate.



OVERLASH & ECONOMY CABLE BLOCKS



AERIAL TOOLS

Economy Overlash Cable Block

This Economy Overlash Cable Block may be placed over existing cable bundles up to 1.5" (38 mm) in diameter. Single rollers are available in plastic or steel and can accommodate cable or innerduct up to 1.00" (25 mm) diameter. Lightweight zinc-plated steel frame opens and closes for easy installation and ensures cable retention.

Replacement rollers available. See page 7 for ordering information.



Part Number	Description	Maximum Cable Diameter		Roller Material
		(in)	(mm)	
18151500	Economy overlash cable block	1.00	25	plastic
18151600	Economy overlash cable block	1.00	25	steel
18501010	Plastic Replacement Roller			
18501043	Steel Replacement Roller			



PRIOR TO ORDERING, ALWAYS KNOW THE FOLLOWING:

- Max Cable O.D. 1" (25 mm)
- Max Bundled O.D. 1.5" (38 mm)
- Blocks Do Not Lock on Strand

Due to heat generated by poly-blend rope during pulling operations, an aluminum roller should be utilized. With cotton ropes or pull tape, plastic rollers are adequate.



Cable Block 18151500

Cable Block 18151600





90 DEGREE CORNER BLOCKS



Due to heat generated by poly-blend rope during pulling operations, an aluminum roller should be utilized. With cotton ropes or pull tape, plastic rollers are adequate.

90° Corner Blocks

Ensure minimal drag is placed on the cable and that minimum bend radius is not exceeded. Pole-mounted blocks guide cable around an inside or outside corner. Corner blocks are available in 90° configurations with a variety of cable carrying capacities.

For the recommended accessories please see **Corner Blocks Mounting Hardware (page 11)** which includes the **Pole Bracket and Pole Bracket Mount Adapter**. Replacement rollers available, page 7.

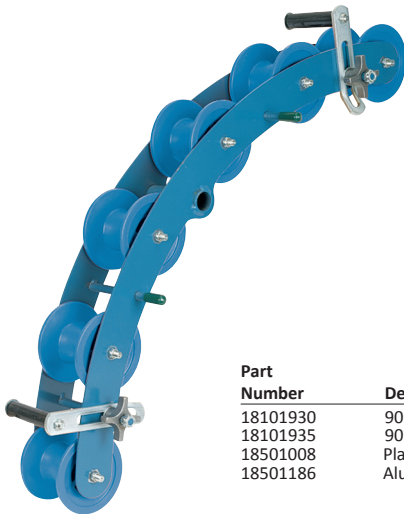

90° Corner Cable Block 18101930

90° Large Diameter Corner Block

A larger bend radius of 23" (584 mm) makes this block effective for larger diameter cable and innerduct—up to 2.75" (70 mm) diameter. Welded and painted steel frame. Plastic rollers are durable and lightweight.

Mounts on Pole Bracket. Order separately, page 11. Replacement rollers available, page 7.

Part Number	Description	Roller/Cable Config.	Frame Material	Roller Material
18101930	90° corner cable block	1 @ 2.75" (70 mm)	steel	plastic
18101935	90° corner cable block	1 @ 2.75" (70 mm)	steel	aluminum
18501008	Plastic Replacement Roller			
18501186	Aluminum Replacement Roller			

90° Corner Blocks

With a bend radius of 22.25" (565 mm), these corner blocks feature a welded and painted steel frame with angular and vertical reinforcements. Plastic rollers are durable and lightweight. Adjustable rubber idler arms retain cable in position.

Mounts on Pole Bracket. Order separately, page 11. Replacement rollers available, page 7.



90° Corner Cable Block 18101940

Part Number	Description	Roller/Cable Config.	Frame Material	Roller Material
18101940	90° corner cable block	1 @ 1.25" (32 mm)	steel	plastic
18501044	Plastic Replacement Roller			



CORNER BLOCKS MOUNTING HARDWARE



AERIAL TOOLS

Pole Bracket

Use the Pole Bracket for all 90° Corner Blocks. A ratcheting strap design provides easy set-up, while offering a tight fit to the pole. Bracket is steel with a vertical shaft to receive Corner Block. A safety clip is provided to hang unit from strand while installing.



Part Number	Description
18104400	Pole bracket mount with ratcheting strap

Pole Bracket Mount Adapter

Installs easily on the Pole Bracket to provide a horizontal axis to mount 45 Degree Corner Blocks that are to be used as a reel-to-strand chute.



Part Number	Description
18106000	Pole bracket mount adapter (requires Pole Bracket)

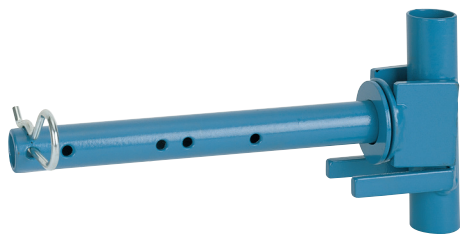



DUCT RODDERS



Duct Rodders

Condux Duct Rodders combine ease of operation and reliable performance to help increase the efficiency of your rodding operations.

Condux Duct Rodder cages have been designed to be lighter weight for easy handling in the field. They feature sturdy construction and a hand-operated wheel brake. They can be used on their side as well as upright. The 30" (762 mm) and 45" (1,143 mm) cages come with wheels for added mobility. Cage sizes are matched to suit the rod you order.

End Fittings Included

Condux Duct Rodders come equipped with a threaded end fitting on each end, and a tapered head on the outward end. Condux offers a number of optional end fitting accessories for additional applications.

Easy to Order

Simply refer to the charts in this section to determine the diameter of rod you need.

All Duct Rodders come standard with a repair kit.

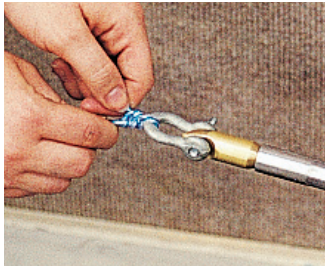

Duct rodder accessories (pgs. 16 - 19) are available to fit your rodding application.

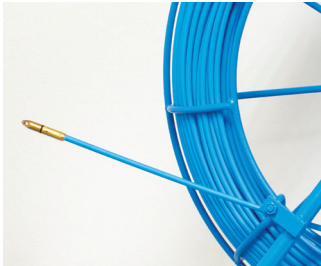

End fittings are included with Condux duct rodders. See Duct Rodder Accessories for size and part number (pgs 16 - 19).



Condux duct rodders feature sturdy construction and reliable performance.



Hand-operated wheel brake adds control and safety.

Duct Rodder Specifications

Duct Rod Diameter		Duct Rod Pull Strength		Core OD**		Coating OD*		Minimum Bending Radius	
(in)	(mm)	(lbs)	(n)	(in)	(mm)	(in)	(mm)	(in)	(mm)
3/16	5	200	890	.125	3.2	.187	4.8	3	76
1/4	6	350	1,557	.187	4.8	.250	6.3	5	127
5/16	8	950	4,226	.237	6.0	.312	7.9	7	178
7/16	11	950	4,226	.300	7.6	.437	11.1	11	280
9/16	13	1,400	6,227	.375	9.5	.500	13.0	11	280

**Core O.D. Tolerance ±.007" (.2 mm); *Coating O.D. Tolerance ±.015" (.4 mm).

Two Types of Rod

Each Condux duct rodder has a glass reinforced composite core jacketed in a rugged plastic coating to ensure long life. They have excellent flexural strength, compressive strength, fatigue resistance, and memory. They also have favorable electrical and thermal properties that make them safe for use in cable-occupied duct. They are suitable for pulling back winch line or small diameter cable.

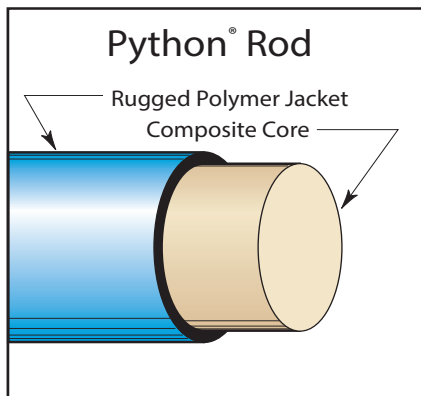

PYTHON[®]: The Python rod has flexibility and it has a heavy-duty outer plastic coating to resist abrasions and reduce wear. Includes one male and one female end fitting, and a tapered head.

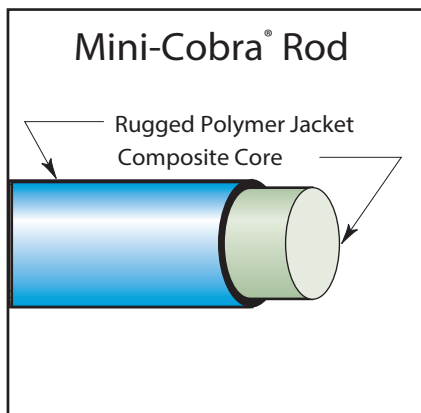

MINI-COBRA[®]: Condux's Mini-Cobra includes $\frac{3}{16}$ " (5 mm) and $\frac{1}{4}$ " (6 mm) diameter rods used primarily for smaller duct sizes and shorter runs. The rod has the same flexibility and strength features of the Python rod and comes wound in 16" (406 mm) and 24" (610 mm) cages in 50' (25 m) to 600' (200 m) lengths. Includes two male end fittings and two tapered heads.

REPLACEMENT ROD: Replacement rod is available for all Condux Duct Rodders. Please contact Condux Customer Service to place your order. Have your existing duct rodder part number ready to ensure an accurate match. Replacement rod comes with end fittings and tapered heads in a disposable replacement cage.

RECOMMENDED DUCT RODDER SIZES FOR CONDUIT													
Conduit Size	1/2" (13mm)	3/4" (19mm)	1" (25mm)	1 1/4" (32mm)	1 1/2" (38mm)	2" (51mm)	2 1/2" (64mm)	3" (76mm)	3 1/2" (89mm)	4" (102mm)	5" (127mm)	6" (152mm)	8" (203mm)
Recommended Duct Rodder Size(s)	3/16" (5mm)	3/16" (5mm)	3/16" (5mm) 1/4" (6mm)	3/16" (5mm) 1/4" (6mm)	1/4" (6mm) 5/16" (8mm)	1/4" (6mm) 5/16" (8mm)	1/4" (6mm) 5/16" (8mm)	5/16" (8mm) 7/16" (11mm) 9/16" (13mm)	5/16" (8mm) 7/16" (11mm) 9/16" (13mm)	5/16" (8mm) 7/16" (11mm) 9/16" (13mm)	7/16" (11mm) 9/16" (13mm)	7/16" (11mm) 9/16" (13mm)	9/16" (13mm)

*Conduit sizes based on standard radius bends and should be considered minimums. A larger diameter rod than what is listed is not recommended. Please call your Condux representative for assistance.



DUCT RODDERS

Duct Rodders (U.S. Threads - USC)

! ORDER CAREFULLY
This item is made-to-order
and is not returnable.

3/16" MINI-COBRA ROD		
#12-24 End Fitting 16" Cage		
<i>Use for duct size .5" - 1.25"</i>		
Part Number	Length (l)	Replacement Rod
08072405	50	08073605
08072410	100	08073610
08072415	150	08073615
08072420	200	08073620
08072425	250	08073625
08072430	300	08073630

1/4" MINI-COBRA ROD		
5/16"-18 End Fitting 24" Cage		
<i>Use for duct size 1" - 2.5"</i>		
Part Number	Length (l)	Replacement Rod
08072510	100	08073710
08072515	150	08073715
08072520	200	08073720
08072525	250	08073725
08072530	300	08073730
08072535	350	08073735
08072540	400	08073740
08072545	450	08073745
08072550	500	08073750
08072555	550	08073755
08072560	600	08073760

5/16" PYTHON ROD		
3/8"-16 End Fitting 30" Cage		
<i>Use for duct size 1.5" - 4"</i>		
Part Number	Length (l)	Replacement Rod
08084320	200	08082320
08084330	300	08082330
08084340	400	08082340
08084350	500	08082350
08084360	600	08082360
08084370	700	08082370
08084380	800	08082380
08084390	900	08082390
08084310	1000	08082310

7/16" PYTHON ROD		
3/8"-16 End Fitting 45" Cage		
<i>Use for duct size 3" - 6"</i>		
Part Number	Length (l)	Replacement Rod
08083920	200	08086520
08083930	300	08086530
08083940	400	08086540
08083950	500	08086550
08083960	600	08086560
08083970	700	08086570
08083980	800	08086580
08083990	900	08086590
08083910	1000	08086510
08083911	1100	08086511
08083912	1200	08086512
08083913	1300	08086513
08083914	1400	08086514
08083915	1500	08086515

9/16" PYTHON ROD		
3/4"-10 End Fitting 45" Cage		
<i>Use for duct size 3" - 8"</i>		
Part Number	Length (l)	Replacement Rod
08083220	200	08075720
08083230	300	08075730
08083240	400	08075740
08083250	500	08075750
08083260	600	08075760
08083270	700	08075770
08083280	800	08075780
08083290	900	08075790
08083210	1000	08075710

*all duct rodders come standard with a repair kit

Footage Marks

Optional footage marks are available on 5/16", 7/16" and 9/16" Python duct rod. Order footage marks by adding an F to the end of the existing part number. Footage marks are every two feet.

Example: If you were ordering 7/16" Python Rod, 1400 feet long you would order: 08083914F.

Additional charges apply.



Duct Rodders (Metric)

5MM MINI-COBRA ROD		
M5 End Fitting 406mm Cage		
<i>Use for duct size 13 - 32mm</i>		
Part Number	Length (m)	Replacement Rod
08072602	25	08072702
08072605	50	08072705
08072607	75	08072707
08072610	100	08072710

6MM MINI-COBRA ROD		
M8 End Fitting 610mm Cage		
<i>Use for duct size 25 - 64mm</i>		
Part Number	Length (m)	Replacement Rod
08072802	25	08072902
08072805	50	08072905
08072807	75	08072907
08072810	100	08072910
08072812	125	08072912
08072815	150	08072915
08072817	175	08072917
08072820	200	08072920

8MM PYTHON ROD		
M12 End Fitting 762mm Cage		
<i>Use for duct size 38 - 102mm</i>		
Part Number	Length (m)	Replacement Rod
08075205	50	08076405
08075207	75	08076407
08075210	100	08076410
08075212	125	08076412
08075215	150	08076415
08075217	175	08076417
08075220	200	08076420
08075225	250	08076425
08075230	300	08076430

11MM PYTHON ROD		
M12 End Fitting 1143 Cage		
<i>Use for duct size 76 - 152mm</i>		
Part Number	Length (m)	Replacement Rod
08078505	50	08078605
08078507	75	08078607
08078510	100	08078610
08078512	125	08078612
08078515	150	08078615
08078517	175	08078617
08078520	200	08078620
08078525	250	08078625
08078530	300	08078630
08078535	350	08078635
08078540	400	08078640
08078545	450	08078645

13MM PYTHON ROD		
M12 End Fitting 1143 Cage		
<i>Use for duct size 76 - 203mm</i>		
Part Number	Length (m)	Replacement Rod
08078705	50	08079305
08078707	75	08079307
08078710	100	08079310
08078712	125	08079312
08078715	150	08079315
08078717	175	08079317
08078720	200	08079320
08078725	250	08079325
08078730	300	08079330

Metric Marks

Optional metric marks are available on 8 mm, 11 mm and 13 mm Python duct rod. Order metric marks by adding an M to the end of the existing part number. Metric marks are every meter.

Example: If you were ordering 11 mm Python Rod, 400 Meters long you would order: 08078540M.

Additional charges apply.





DUCT RODDER ACCESSORIES

Duct Rodder Accessories

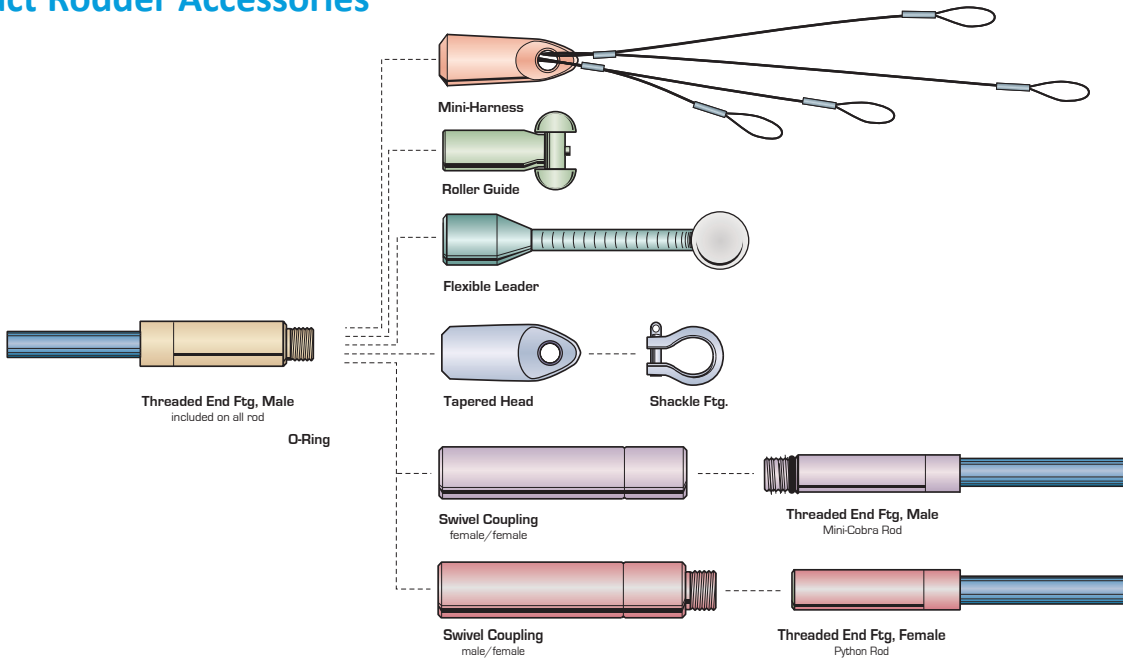

Accessory Kit

Popular accessories available in a convenient bag that attaches to the cage. Kit Includes: Canvas Bag, Roller Guide, Splice Kit, Epoxy, Swivel Coupling, Tapered head, and Threaded End Fittings.

Rod Dia., in (mm)	3/16 (5)	1/4 (6)	5/16 (8)	7/16 (11)	9/16 (13)
USC Thread	#12-24	5/16-18	3/8-16	3/8-16	3/4-10
Accessory Kit	08033498	08033499	08033497	08033494	08033488
Metric Thread	M5	M8	M12	M12	M12
Accessory Kit	08033492	08033493	08033496	08033495	08033489

*Kits for 3/16" (5 mm) and 1/4" (6 mm) rod also include a Flexible Leader and O-Rings.

Bag Only 08033490



Repair Kit

Replacement repair kit that comes standard with duct rod. Accessories available in a convenient bag that attaches to the cage.

Rod Dia., in (mm)	3/16 (5)	1/4 (6)	5/16 (8)	7/16 (11)	9/16 (13)
Replacement Kit	08035770	08035772	08035774	08035776	08035778

Splice Kit

Use to repair the duct rod if it breaks. Kit includes: Splice Tube, Epoxy and installation instructions.



Rod Dia., in (mm)	3/16 (5)	1/4 (6)	5/16 (8)	7/16 (11)	9/16 (13)
Splice Kit	08033457	08033465	08035753	08035751	08035752
Splice Tube Only	08033455	08033463	08035703	08035701	08035702

Epoxy

Use with End Fittings or Splice Tubes to repair Duct Rodders.

Part Number	Description
08035851	Single pack for replacing end fittings
08035852	Double pack for splice tubes

Mini Harness

Screws onto the threaded end fitting to allow for easy wire attachment when pulling wire into conduit.

Rod Dia., in (mm)	3/16 (5)	1/4 (6)	5/16 (8)	7/16 (11)	9/16 (13)
USC Thread	#12-24	5/16-18	3/8-16	3/8-16	3/4-10
Mini Harness	08033433	08033434	08033435	08033435	08033436
Metric Thread	M5	M8	M12	M12	M12
Mini Harness	08033432	08033431	08033437	08033437	08033437



Roller Guide

Helps guide the duct rod around bends, sweeps, and duct misalignments. Also used when the conduit is already occupied by other cables.

US Duct Rodders Rod Diameter (in)	USC Thread	Roller Guide Part Number	Duct Range I.D. (in)
3/16	#12-24	08037430	.50 - 1.25
1/4	5/16-18	08037440	1.00 - 2.50
5/16	3/8-16	08037460	1.50 - 6.00
5/16	3/8-16	08037401	2.50 - 6.00
7/16	3/8-16	08037401	2.50 - 6.00
9/16	3/4-10	08037400	3.00 - 8.00
Metric Duct Rodders Rod Diameter (mm)	Metric Thread	Roller Guide Part Number	Duct Range I.D. (mm)
(5)	M5	08037428	12.7 - 32
(6)	M8	08037450	25 - 63
(8)	M12	08037405	63 - 152
(11)	M12	08037405	63 - 152
(13)	M12	08037405	76 - 203

5/16" (8mm) - 9/16" (13mm)

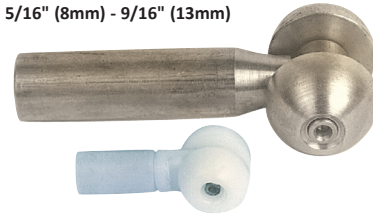

3/16" (5mm) - 1/4" (6mm)

Flexible Leader

Helps guide the duct rod around bends, sweeps, and duct misalignments.

Rod Dia., in (mm)	3/16 (5)	1/4 (6)	5/16 (8)	7/16 (11)	9/16 (13)
USC Thread	#12-24	5/16-18	3/8-16	3/8-16	3/4-10
Flexible Ldr.	08033423	08033443	08037538	08037538	08037534
Metric Thread	M5	M8	M12	M12	M12
Flexible Ldr.	08033448	08033444	08037512	08037512	08037512



Shackle Fitting

Fits onto Tapered Head to provide a larger pulling loop for attaching the rope or pull line.

Rod Dia., in (mm)	3/16 (5)	1/4 (6)	5/16 (8)	7/16 (11)	9/16 (13)
USC Thread	#12-24	5/16-18	3/8-16	3/8-16	3/4-10
Shackle Fitting	-	-	08031101	08031101	08031100
Metric Thread	M5	M8	M12	M12	M12
Shackle Fitting	-	-	08031101	08031101	08031101





DUCT RODDER ACCESSORIES

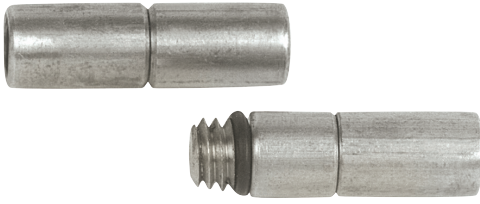

Swivel Coupling

Used to connect two duct rods pushed into the conduit from the same end. Used when one length of duct rod is not long enough for the full conduit run. Also used as a rotating swivel when pulling wire or rope with the Tapered Head or Mini-Harness.

Rod Dia., in (mm)	3/16 (5)	1/4 (6)	5/16 (8)	7/16 (11)	9/16 (13)
USC Thread	#12-24	5/16-18	3/8-16	3/8-16	3/4-10
Female/Female	08033470	08033459	-	-	-
Male/Female	08033422	08033442	08036800	08036800	08036700
Metric Thread	M5	M8	M12	M12	M12
Female/Female	08033429	08033483	-	-	-
Male/Female	08033426	08033485	08036806	08036806	08036806

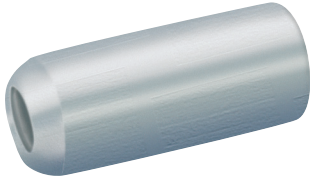

Sonde Adapter

Couples a locating sonde or other device with an M10 male thread to the male end fitting of the duct rod. Specify sonde, thread and rodder.

Rod Dia., in (mm)	3/16 (5)	1/4 (6)	5/16 (8)	7/16 (11)	9/16 (13)
USC Thread	#12-24	5/16-18	3/8-16	3/8-16	3/4-10
Sonde Adapter	-	08036500	08036503	08036503	08036504
Metric Thread	M5	M8	M12	M12	M12
Sonde Adapter	-	08036505	08036501	08036501	08036501

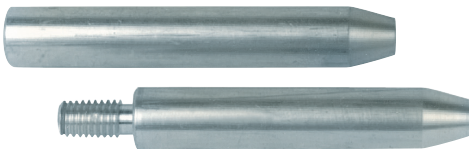

Threaded End Fittings

Use as a replacement to the factory installed end fittings if the end fitting breaks off or if the duct rod breaks close to the end of the rod. Installation instructions are included with the end fittings. Epoxy is required for installation and is ordered separately.

Rod Dia., in (mm)	3/16 (5)	1/4 (6)	5/16 (8)	7/16 (11)	9/16 (13)
USC Thread	#12-24	5/16-18	3/8-16	3/8-16	3/4-10
Male	08033420K	08033440K	08036307K	08036303K	08036005K
Female	-	-	08036306K	08036304K	08036006K
Metric Thread	M5	M8	M12	M12	M12
Male	08033487	08033486	08036318	08036319	08036316
Female	-	-	08036317	08036314	08036315

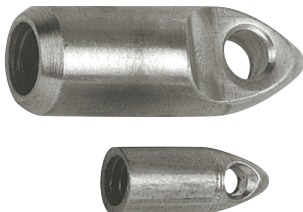

Tapered Head

Attaches to the end fitting on the duct rod. Guides duct rod through the conduit and allows a pull line (diameter A) to be attached to the duct rod. Comes standard with each of the duct rod ders.

Rod Dia., in (mm)	3/16 (5)	1/4 (6)	5/16 (8)	7/16 (11)	9/16 (13)
USC Thread	#12-24	5/16-18	3/8-16	3/8-16	3/4-10
Tapered Head	08033421	08033441	08038400	08038400	08038300
Diameter A	.156 (4)	.156 (4)	.281 (7)	.281 (7)	.343 (9)
Metric Thread	M5	M8	M12	M12	M12
Tapered Head	08033410	08033480	08038301	08038301	08038301
Diameter A	.156 (4)	.156 (4)	.281 (7)	.281 (7)	.281 (7)

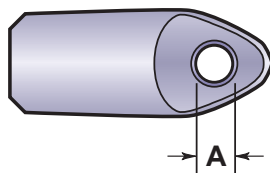



DUCT RODDER ACCESSORIES

O-Rings

Used to help keep accessories on the end fitting while rodding. Comes standard with the Mini-Cobra rodders.



Rod Dia., in (mm)	3/16 (5)	1/4 (6)	5/16 (8)	7/16 (11)	9/16 (13)
USC Thread	#12-24	5/16-18	3/8-16	3/8-16	3/4-10
O-Rings	02163600	02215000	-	-	-
Metric Thread	M5	M8	M12	M12	M12
O-Rings	02163600	02215000	-	-	-

Duct Rodder Replacement Brake Handles

Use Condux Duct Rodder Replacement Brake Handles to replace missing or damaged handles on existing cages.



Part No.	Description
02218300	16" (406 mm) Duct Rodder Replacement Brake Handle
08081547	24" (610 mm) Duct Rodder Replacement Brake Handle
08081547	30" (762 mm) Duct Rodder Replacement Brake Handle
08081567	45" (1,143 mm) Duct Rodder Replacement Brake Handle

Duct Rodder Replacement Cages

Use Condux Duct Rodder Replacement Cages to update older cages or to replace damaged cages. Fits all major manufacturers' fiberglass rods.

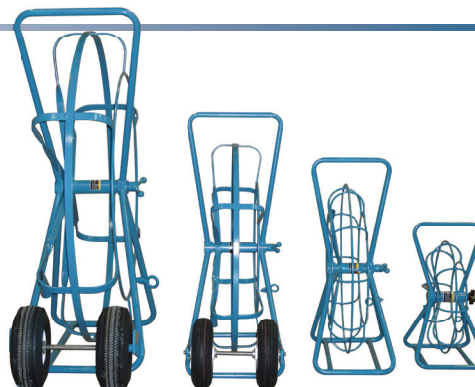

45" (1143 mm) 30" (762 mm) 24" (610 mm) 16" (406 mm)

Rod Dia., in (mm)	3/16 (5)	1/4 (6)	5/16 (8)	7/16 (11)	9/16 (13)
Replacement Cage	08081516R	08081524R	08081530R	08081550R	08081550R

Fiberglass Hand Rods

Screw together fiberglass duct rods for straight runs. All rods equipped with 3/4"-10 end fittings. 2,500 lbs. (11,120 N) pull rating.



Part Number	Size (in x ft)	Size (mm x m)
08032026	5/8 x 5	16 x 1.5
08032022	5/8 x 10	16 x 3

Replacement Hand Rod End Fittings

Part Number	Size/Type in (mm)
08036157	3/4"-10 male end for 5/8" (16 mm) rod
08036156	3/4"-10 female end for 5/8" (16 mm) rod
08035851	Epoxy Resin, Single Pack

! ORDER CAREFULLY
This item is made-to-order
and is not returnable.





LOW PRESSURE SEAL-OFFS

Conduit Seal-Offs

Conduit Seal-Offs utilize compressed air (up to 15 psi) to force Line Carriers, Cable Chutes or other projectiles (see page 24-25) thru the duct system while dragging a pull string or pull tape (page 30). Once the tape or string is installed, pulling rope (see page 31) or steel cable can be pulled back. In the case of small conductors or fiber cables, it's possible that the string or tape will handle the job. For your compressor needs, see page 122.

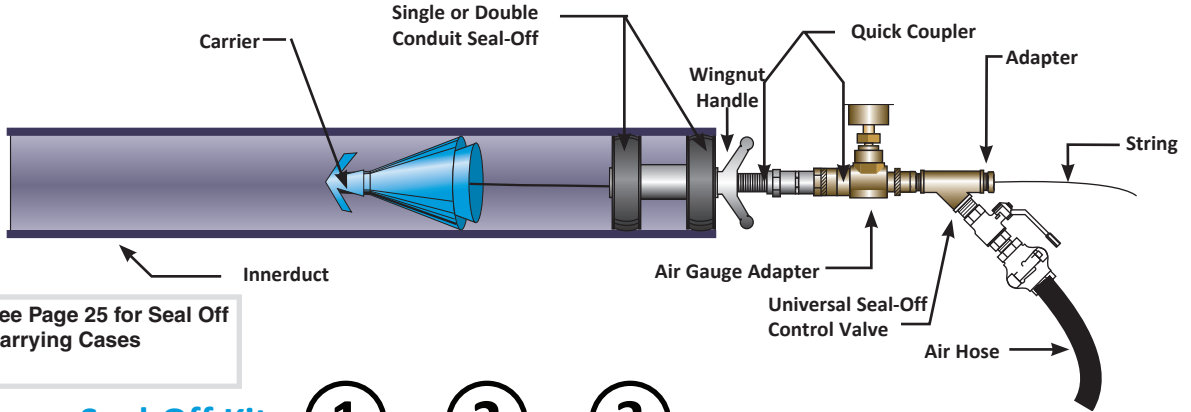

! See Page 25 for Seal Off Carrying Cases

Create your Seal-Off Kit: **1** + **2** + **3**

! 15 PSI MAX PRESSURE

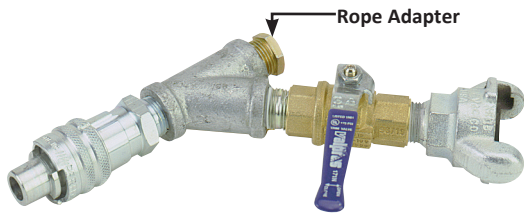

1

Universal Seal-Off Control Valve

The Seal-Off Control Valve Body combines with an Innerduct Seal-Off, Single Conduit Seal-Off or Double Conduit Seal-Off and recommended Air Gauge Adapter to form a complete Seal-Off Assembly. The interchangeable attachments provide flexibility by allowing the purchase of a single valve body that can be used in a variety of applications depending on conduit size. The Seal-Off Control Valve Body comes standard with an air valve to regulate flow, a standard claw type air fitting and a 3/16" (5 mm) Rope Adapter.

Part Number	Description
08032165	Seal-Off control valve body



2

Individual Innerduct Seal-Offs

The Innerduct Seal-Offs fit the Seal-Off Control Body and thread into Innerduct. See available sizes below.

Part Number	Description	Nominal Duct Size		Innerduct I.D. Range	
		(in)	(mm)	(in)	(mm)
08034321	3/4" Innerduct Seal-Off	3/4	.72-1.00	.72-.94	19-24
08034315	1" Innerduct Seal-Off	1	.93-1.19	.93-1.19	24-30
08034316	1 1/4" Innerduct Seal-Off	1 1/4	1.18-1.44	1.18-1.44	30-37
08034317	1 1/2" Innerduct Seal-Off	1 1/2	1.31-1.69	1.31-1.69	33-43
08034318	2" Innerduct Seal-Off	2	1.93-2.31	1.93-2.31	49-59
08032999	Case, Innerduct Seal Off (Holds 4 Seal-Offs)				

! 15 PSI MAX PRESSURE



2

Individual Conduit Seal-Offs

The Conduit Seal-Offs fit the Seal-Off Control Body and accommodates larger conduit. See available sizes below.

Part Number	Description	Nominal Duct Size		Duct I.D. Range	
		(in)	(mm)	(in)	(mm)
08032900	2" Conduit Seal-Off	2	1.93-2.36	1.93-2.36	49-60
08032905	2 1/2" Conduit Seal-Off	2 1/2	2.40-2.76	2.40-2.76	61-70
08032910	3" Conduit Seal-Off	3	2.87-3.31	2.87-3.31	73-84
08032915	3 1/2" Conduit Seal-Off	3 1/2	3.50-3.75	3.50-3.75	89-95
08032920	4" Conduit Seal-Off	4	3.54-4.25	3.54-4.25	90-108
08032925	5" Conduit Seal-Off	5	4.72-5.37	4.72-5.37	120-136
08032930	6" Conduit Seal-Off	6	5.50-6.29	5.50-6.29	140-160
08032935	8" Conduit Seal-Off	8	7.83-8.27	7.83-8.27	199-210
08032995	Case, Conduit Seal Off Single (Holds 7 Seal-Offs)				



LOW PRESSURE SEAL-OFFS



FISHING & RODDING

Individual Double Seal-Offs

The Conduit Seal-Offs fit the Seal-Off Control Body and accommodate larger pipes. See available sizes below.

Part Number	Description	Nominal Duct Size (in)	Duct I.D. Range (in) (mm)	
08032940	2" Double Seal-Off	2	1.93–2.36	49–60
08032945	2½" Double Seal-Off	2½	2.40–2.76	61–70
08032950	3" Double Seal-Off	3	2.87–3.31	73–84
08032955	3½" Double Seal-Off	3½	3.50–3.75	89–95
08032960	4" Double Seal-Off	4	3.54–4.25	90–108
08032965	5" Double Seal-Off	5	4.72–5.37	120–136
08032970	6" Double Seal-Off	6	5.50–6.29	140–160
08032975	8" Double Seal-Off	8	7.83–8.27	199–210
08032997	Case, Conduit Seal Off Double (Holds 5 Seal-Offs)			

2

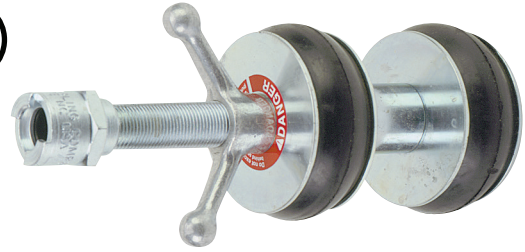

Air Gauge Adapter

The Air Gauge Adapter allows the monitoring of pressures reached when using a Seal-Off Assembly. While optional, it's highly recommended to avoid exceeding the 15 PSI maximum.

Part Number	Description
08032175	Air Gauge Adapter

3



Rope Adapter Kit

The interchangeable Rope Adapters for the Seal-Off Control Body allow larger strings and tapes to be utilized while minimizing back pressure air loss. Individual adapters are available in 3/16" (5 mm), 1/4" (6 mm) and 3/8" (10 mm) or they can be purchased as a kit – one of each.

Part Number	Description
08032181	Adapter Kit for Conduit Seal-Offs
08032190	3/16" (5 mm) Rope Adapter
08032191	1/4" (6 mm) Rope Adapter
08032170	3/8" (10 mm) Rope Adapter



Replacement Seals for Conduit Seal-Offs

The rubber seals on single and double Conduit Seal-Offs should be replaced when they no longer grip properly or in cases of significant air loss.

Part Number	Nominal Duct Size (in)
08082121	2
08082126	2½
08082131	3
08082136	3½
08082141	4
08082151	5
08082161	6



Replacement Handle for Single & Double Seal-Offs

The Replacement Handle allows the repair of Seal-Offs where the wing nut has broken or is missing. The handle fits both Single and Double Seal-Offs.

Part No.	Description
08032179	Replacement Handle for Single and Double Seal-Offs





POWER DART® BLOWER

FISHING & RODDING

Power Dart® Blower

The Power Dart Blower provides a method to install Pull String or Pull Tape into longer duct runs without the need for an air compressor. Utilizing three independent, high volume blower motors, this unit delivers 300 CFM (8.5 m³/min) @ 3 PSI (.2 Bar) – more than enough to blow 1/2" (12.7 mm) pull string or pull tape 2000' (610 m) into conduit up to 6" (152 mm) in diameter. By running one, two or all three motors, the operator can regulate the speed of the installation. The Condux® Power Dart® Blower weighs only 31 lbs (14 kg) making it a breeze to carry from install to install.

*Requires 110V/220V AC Power or 3,000 Watt Generator. Comes w/30 Amp Twist Plug Installed.

Base Part No.	Description
08030003	110V Power Dart Blower (Includes: 110V Power Dart Blower Unit, Hose, Seal-Off Handle & Seal-Offs for 1/2" - 6" (13 mm-152 mm) conduit Carriers not included.)
08030004	220V/240V Power Dart Blower (Includes: 220V/240V Power Dart Blower Unit, Hose, Seal-Off Handle & Seal-Offs for 1/2" - 6" (13 mm-152 mm) conduit Carriers not included.)
08030060	Power Dart Blower Accessory Bag Convenient, canvas bag holds Power Dart hose. Inner bag holds Line Carriers, Foam Carriers, Seal-Off Body and Seal-Offs.
08030011	Power Dart Blower Carrier Kit
Qty	Part Number Description
(2)	08067900 2" (51 mm) Line Carrier
(1)	08030300 4" (102 mm) Line Carrier
(2)	08031820 2" (51 mm) Duct Projectile
(1)	08031840 4" (102 mm) Duct Projectile
(1)	08033532 Carrier, Chute 2" (51 mm) Nylon
(1)	08033548 Carrier, Chute 3" (76 mm) Nylon
(1)	08033564 Carrier, Chute 4" (102 mm) Nylon
(1)	08039400 Seal-Off Body Handle
(1)	08066800 Power Dart Seal-Off 1 1/2"- 2 1/2" (38-64 mm)
(1)	08039500 Power Dart Seal-Off 2 1/2"- 6" (64-152 mm)



Power Dart Blower
Part # 08030003



Accessory Bag
Part # 08030060



Optional Carrier Kit
Part # 08030011

Replacement Accessories

Power Dart Blower Seal-Off

Part Number	Duct Size	
	(in)	(mm)
08039700*	1/2-1 1/4	13-32
08066800	1 1/2-2 1/2	38-64
08039500	2 1/2-6	64-152

*Requires Part Number 08066800

Power Dart Blower Seal-Off Handle

Part Number	Duct Size	
	(in)	(mm)
08039400	1/2-6	13-152

Power Dart Blower Hose

Part Number	Description
08039300	25' (7.6 m) x 2 1/2" (64 mm) heavy duty hose
08039301	Replacement hose end fitting
08039302	Outlet Fitting on the power dart blower box



Seal-Off, 1/2"-1 1/4" (13-32 mm)
Part # 08039700*



Seal-Off, 1 1/2"-2 1/2" (38-64 mm)
Part # 08066800



Seal-Off, 2 1/2"-6" (64-152 mm)
Part # 08039500



Seal-Off Handle
Part # 08039400



POWER DART® BLOWER ACCESSORIES



FISHING & RODDING

Quick Connect Seal-Off Control Valve

The Quick Connect Seal-Off Control Valve is used to connect the Power Dart Blower Seal-Offs to a standard air compressor claw fitting. Comes equipped with an air flow valve and a universal hose coupling for attachment to most compressors. A 3/16" (5 mm) rope adapter included. See page 21 for additional rope adapter sizes.

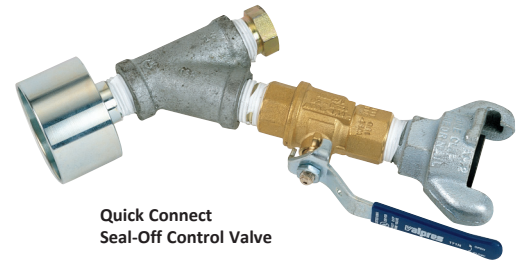

Quick Connect Seal-Off Control Valve

Part Number	Description
08032185	Quick connect seal-off control valve

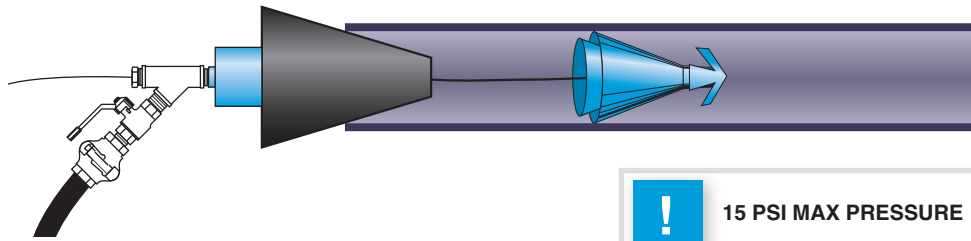

Carrier Options

Foam Carrier: Lightweight carrier easily blows through duct. Best suited for short runs and runs with multiple bends.

Part Number	Description
08078200	1/2" (13 mm) Foam Carrier
08078300	3/4" (19 mm) Foam Carrier
08032200	1" (25 mm) Foam Carrier
08032300	1 1/4" (32 mm) Foam Carrier
08039800	1 1/2" (38 mm) Foam Carrier
08033500	45 mm Foam Carrier
08032400	2" (51 mm) Foam Carrier
08078400	2 1/2" (64 mm) Foam Carrier
08032500	3" (76 mm) Foam Carrier
08032100	3 1/2" (89 mm) Foam Carrier
08032600	4" (102 mm) Foam Carrier
08059100	5" (127 mm) Foam Carrier
08059200	6" (152 mm) Foam Carrier

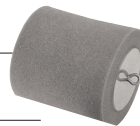

Line Carrier: Fast and efficient plastic carriers for fishing with high-speed blowers even in out-of-round duct. Carrier will travel over minor obstructions in duct.

Part Number	Description
08067900	2" (51 mm) Line Carrier
08030100	3" (76 mm) Line Carrier
08030200	3 1/2" (89 mm) Line Carrier
08030300	4" (102 mm) Line Carrier
08030400	5" (127 mm) Line Carrier
08030500	6" (152 mm) Line Carrier



Cable Chute Line Carrier: designed to pass through conduit without damaging an existing cable. All Cable Chute Line Carriers are made with the highest quality fabrics (nylon or leather) and attention to detail. All products are handmade and go through a series of quality checks prior to being shipped out.

Part Number	Description
08033512	Carrier, Chute 0.75" (19mm) Nylon
08033516	Carrier, Chute 1.00" (25mm) Nylon
08033520	Carrier, Chute 1.25" (32 mm) Nylon
08033524	Carrier, Chute 1.50" (38mm) Nylon
08033532	Carrier, Chute 2.00" (51 mm) Nylon
08033548	Carrier, Chute 3.00" (76 mm) Nylon
08033564	Carrier, Chute 4.00" (102 mm) Nylon
08033580	Carrier, Chute 5.00" (127mm) Nylon
08033596	Carrier, Chute 6.00" (152mm) Nylon
08033648	Carrier, Chute 3.00" (76 mm) Nylon w/Spring
08033664	Carrier, Chute 4.00" (102mm)Nylon w/Spring
08033680	Carrier, Chute 5.00" (127mm)Nylon w/Spring
08033696	Carrier, Chute 6.00" (152mm)Nylon w/Spring
08033732	Carrier, Chute 2.00" (51mm) Leather
08033748	Carrier, Chute 3.00" (76mm) Leather
08033764	Carrier, Chute 4.00" (102mm) Leather
08033796	Carrier, Chute 6.00" (152mm) Leather



Duct Projectile Options: Flexible rubber cones are durable for many repeated uses. Fast and efficient for long runs with easy pull-back.

Part Number	Description
08031812	1 1/4" (32 mm) Duct Projectile
08031814	1 3/8" (35 mm) Duct Projectile
08031815	1 1/2" (38 mm) Duct Projectile
08031816	1 5/8" (41 mm) Duct Projectile
08031820	2" (51 mm) Duct Projectile
08031822	2 1/4" (57 mm) Duct Projectile
08031825	2 1/2" (64 mm) Duct Projectile
08031830	3" (76 mm) Duct Projectile
08031835	3 1/2" (89 mm) Duct Projectile
08031840	4" (102 mm) Duct Projectile
08031844	4 1/4" (108 mm) Duct Projectile
08031846	4 1/2" (114 mm) Duct Projectile
08031850	5" (127 mm) Duct Projectile
08031860	6" (152 mm) Duct Projectile
08031880	8" (203 mm) Duct Projectile





CONDUIT CARRIERS



Foam Carriers

Lightweight carrier easily blows through duct. Best suited for short runs and runs with multiple bends.

Part Number	Duct Size		Max O.D.	
	(in)	(mm)	(in)	(mm)
08078200	1/2	13	.50	13
08078300	3/4	19	.75	19
08032200	1	25	1.00	25
08032300	1 1/4	32	1.25	32
08039800	1 1/2	38	1.50	38
08033500		45		45
08032400	2	51	2.00	51
08078400	2 1/2	64	2.50	64
08032500	3	76	3.00	76
08032100	3 1/2	89	3.50	89
08032600	4	102	4.00	102
08059100	5	127	5.00	127
08059200	6	152	6.00	152



08067900 only

Line Carriers

Fast and efficient plastic carriers for fishing with high-speed blowers even in out-of-round duct. Carrier will travel over minor obstructions in duct.

Part Number	Duct Size		Max O.D.	
	(in)	(mm)	(in)	(mm)
08067900	2	51	2.06	52
08030100	3	76	3.06	78
08030200	3 1/2	89	3.56	90
08030300	4	102	4.06	103
08030400	5	127	5.06	129
08030500	6	152	6.06	154



Cable Chute Line Carriers

Condux Cable Chute Line Carriers are designed to pass through conduit without damaging the conduit or existing cable. To use a Cable Chute Line Carrier, tie a line to a Chute, insert the Chute into the Conduit or duct, and blow compressed air propelling the Chute to the end of the duct.

All Cable Chute Line Carriers are made with the highest quality fabrics (nylon or leather) and attention to detail. All products are hand made and go through a series of quality checks prior to being shipped out.

Cable Chute Advantages

- No damage to cable or conduit
- Eliminates need for duct rodding
- Durable and flexible
- Quick and easy installation
- Cost effective



Part Number	Description	(mm)
08033512	Carrier, Chute 0.75 Nylon	19
08033516	Carrier, Chute 1.00 Nylon	25
08033520	Carrier, Chute 1.25 Nylon	32
08033524	Carrier, Chute 1.50 Nylon	38
08033532	Carrier, Chute 2.00 Nylon	51
08033548	Carrier, Chute 3.00 Nylon	76
08033564	Carrier, Chute 4.00 Nylon	102
08033580	Carrier, Chute 5.00 Nylon	127
08033596	Carrier, Chute 6.00 Nylon	152
08033648	Carrier, Chute 3.00 Nylon w/Spring	76
08033664	Carrier, Chute 4.00 Nylon w/Spring	102
08033680	Carrier, Chute 5.00 Nylon w/Spring	127
08033696	Carrier, Chute 6.00 Nylon w/Spring	152
08033732	Carrier, Chute 2.00 Leather	51
08033748	Carrier, Chute 3.00 Leather	76
08033764	Carrier, Chute 4.00 Leather	102
08033796	Carrier, Chute 6.00 Leather	152



Duct Projectile

Flexible rubber cones are durable for many repeated uses. Fast and efficient for long runs with easy pull-back.

Part Number	Duct Size		Max O.D.	
	(in)	(mm)	(in)	(mm)
08031812	1¼	32	1.25	32
08031814	1⅝	35	1.37	35
08031815	1½	38	1.50	38
08031816	1⅞	41	1.62	41
08031820	2	51	2.00	51
08031822	2¼	56	2.20	56
08031825	2½	64	2.50	64
08031830	3	76	3.00	76
08031835	3½	89	3.50	89
08031840	4	102	4.00	102
08031844	4¼	108	4.25	108
08031846	4½	115	4.51	115
08031850	5	127	5.00	127
08031860	6	152	6.00	152
08031880	8	203	8.00	203



Replacement Cones For Duct Projectile

Original equipment replacement cones.

Part Number	Duct Size		Max O.D.	
	(in)	(mm)	(in)	(mm)
08031805	1¼	32	1.25	32
08031803	1⅝	35	1.38	35
08031806	1½	38	1.50	38
08031804	1⅞	41	1.63	41
08031819	2	51	2.00	51
08031821	2¼	56	2.20	56
08031826	2½	64	2.50	64
08031831	3	76	3.00	76
08031802	3½	89	3.50	89
08031841	4	102	4.00	102
08031801	4¼	108	4.25	108
08031847	4½	115	4.51	115
08031851	5	127	5.00	127
08031861	6	152	6.00	152
08031881	8	203	8.00	203





WINCH LINE BLOWER



The Condux Winch Line Blower

The Condux Winch Line Blower is a tool for installing winch line, rope or pull tape into conduit. It turns the job of placing winch line into one easy step, eliminating the need to blow a string and pull back a rope.

Using compressed air, 90 psi (6.2 bar) and 100 cfm (2.8 cmm), the winch line blower can propel steel winch line, rope or tape in conduit from 1" to 6" in diameter.

Installation is easy. No special tools are required.

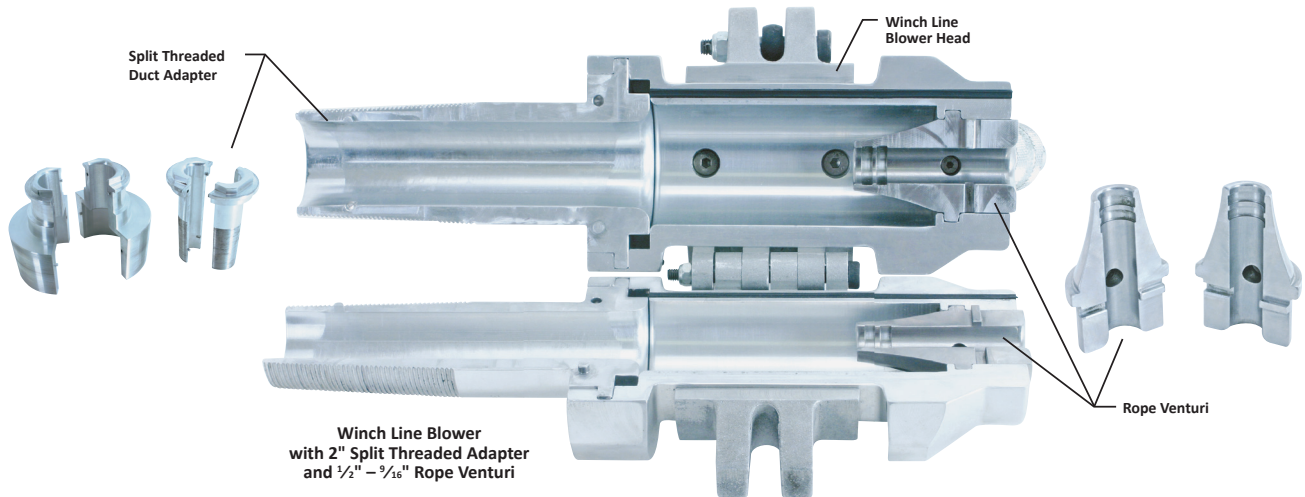

Winch Line Blower with 2" Split Threaded Adapter and 1/2" - 9/16" Rope Venturi

Split Threaded Adapter Part No.	Duct Size (in)	(Duct I.D. Range)	Rope Venturi			Conduit Carrier
			1/4" - 3/8" (6 mm - 10 mm)	1/2" - 9/16" (12.7 mm - 14 mm)	7/8" (22 mm)	
08201108	.75	0.83" - .93" (21 mm - 24 mm)	08201089	08201086	08201090	Call Factory
08201110	1	0.90" - 1.13" (23 mm - 29 mm)	08201089	08201086	08201090	Call Factory
08201112	1.25	1.25" - 1.40" (32 mm - 36 mm)	08201089	08201086	08201090	Call Factory
08201115	1.5	1.40" - 1.65" (36 mm - 42 mm)	08201089	08201086	08201090	Call Factory
08201020	2	1.91" - 2.10" (49 mm - 53 mm)	08201089	08201086	08201090	08202020
08201025	2.5	2.29" - 2.47" (58 mm - 63 mm)	08201089	08201086	08201090	08202520
08201030	3	2.83" - 3.10" (72 mm - 78 mm)	08201089	08201086	08201090	08202920
08201035	3.5	3.25" - 3.60" (83 mm - 91 mm)	08201089	08201086	08201090	08203020
08201041	4	3.80" - 4.06" (97 mm - 103 mm)	08201089	08201086	08201090	08203920
08201045	4.5	4.20" - 4.70" (107 mm - 119 mm)	08201089	08201086	08201090	08204020
08201051	5	4.71" - 5.08" (120 mm - 129 mm)	08201089	08201086	08201090	08204920
08201061	6	5.61" - 6.10" (142 mm - 155 mm)	08201089	08201086	08201090	08205920

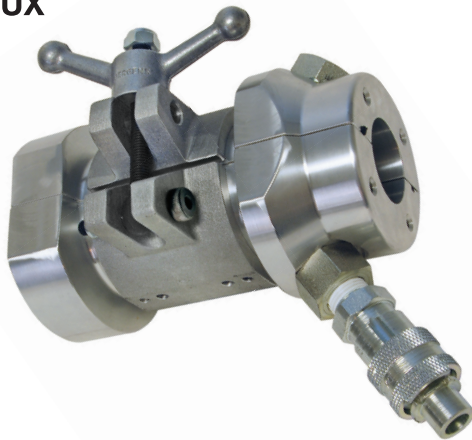

PULLING TAPE INSTALLATION AS AN OVERLAY



Change the Rope Plug on the Winchline Body to the Rope Adapter.



Thread pulling tape through the Rope Adapter.



Attach cable chute line carrier to Pull Tape.



Install cable chute line carrier into duct.



Close adapter around the pulling tape and existing cable. Install into duct.

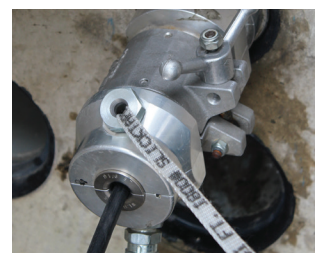

Attach body to the adapter. Close and tighten, running existing cable out of the back.

WINCH LINE & ROPE INSTALLATION



Attach winch line or rope to carrier.



Install carrier into duct.



Close adapter around the winch line or rope. Install into duct.



Install Winch Line Body and tighten the clamp.





WINCH LINE BLOWER

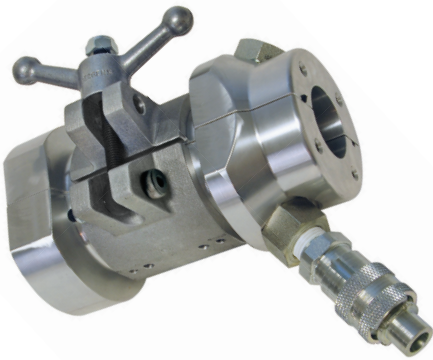

Winch Line Body

Part No.	Description
08201080	Winch Line Body Assembly 2" - 6" (body includes 1/2" - 9/16" venturi set)

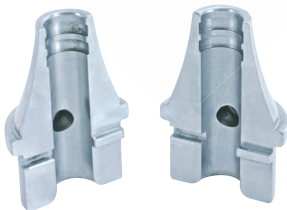

Venturis

Part No.	Description
08201089	Venturi, Winch Line 1/4" - 3/8" set
08201086*	Venturi, Winch Line 1/2" - 9/16" set
08201090	Venturi, Winch Line 7/8" set

* Comes standard with Winch Line Body



Plug

Part No.	Description
08780223	Venturi Plug (Used to seal off back of Winch Line Blower to blow in pull tape or pea line)



Hose & Valve

Part No.	Description
08201015	Hose Valve Assembly

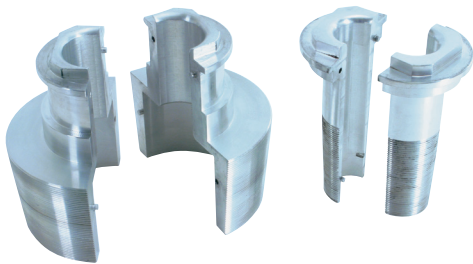

Adapters

Part No.	Description
08201108	Winch Line Duct Adapter .75"
08201110	Winch Line Duct Adapter 1"
08201112	Winch Line Duct Adapter 1.25"
08201115	Winch Line Duct Adapter 1.5"
08201020	Winch Line Duct Adapter 2"
08201025	Winch Line Duct Adapter 2.5"
08201030	Winch Line Duct Adapter 3"
08201035	Winch Line Duct Adapter 3.5"
08201041	Winch Line Duct Adapter 4"
08201045	Winch Line Duct Adapter 4.5"
08201051	Winch Line Duct Adapter 5"
08201061	Winch Line Duct Adapter 6"

! Not for use in steel conduit.

See ranges on page 26.



WINCH LINE BLOWER



FISHING & RODDING

Carriers

Part Number	Description	Carrier OD
08202020	Carrier, Winch Line 2" SCH40&80, TC6	2.05" (53 mm)
08202520	Carrier, Winch Line 2.5" SCH40&80	2.50" (64 mm)
08202920	Carrier, Winch Line 3" SCH 40&80	3.13" (80 mm)
08203020	Carrier, Winch Line 3" SCH40, TC6&8	3.50" (89 mm)
08203420	Carrier, Winch Line 3.5" SCH 40&80	3.75" (95 mm)
08203520	Carrier, Winch Line 3.5" TC6&8	4.00" (102 mm)
08203920	Carrier, Winch Line 4" SCH40&80, TEL	4.25" (108 mm)
08204020	Carrier, Winch Line 4" SCH40,TEL	4.50" (114 mm)
08204920	Carrier, Winch Line 5" SCH 40&80	5.25" (133 mm)
08205020	Carrier, Winch Line 5" SCH40, TC6&8	5.50" (140 mm)
08205920	Carrier, Winch Line 6" SCH 40&80	6.25" (159 mm)
08206020	Carrier, Winch Line 6" SCH40, TC6&8	6.50" (165 mm)



! Not for use in steel conduit.

Alternate carrier options available on pages 24-25. See: Line Carriers, Cable Chute Line Carriers and Duct Projectiles.

Rope Adapter

Rope Adapter
08201091



Storage Case

Storage Case
08201093





POLY LINE PAIL/MEASURING & PULL TAPE



Poly Line Pail

Line attaches to the back of a foam carrier, inflatable carrier or line carrier and is used to pull back a rope. Packaged in a weather-proof, reusable plastic bucket with lid.

Part Number	Break Strength		Length	
	(lbs)	(N)	(ft)	(m)
08561285*	200	890	6,500	1,981
08561297*	450	2,002	2,500	762

*Pallet quantities of 48 available.

Poly Line Replacement String

Replacement string refills.

Part Number	Break Strength		Length	
	(lbs)	(N)	(ft)	(m)
08561284*	200	890	6,500	1,981
08561299*	450	2,002	2,500	762

*Pallet quantities of 80 available.

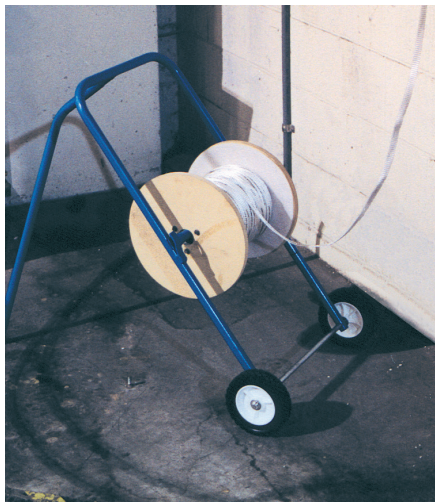

Conduit Measuring & Pull Tape, Polyester

For pulling fiber optic or coaxial cable through innerduct or for determining exact wall-to-wall measurements in duct runs.

Part Number	Break Strength		Approx Width		Length	
	(lbs)	(N)	(in)	(mm)	(ft)	(m)
08073900*	130	578	$\frac{3}{16}$	5	3,000	914

*Pallet quantities of 48 available.



Polyester Woven Pre-Lubed Tape

Recommended pulling tape for fiber optic and coaxial cable pulling. Pre-lubricated tape provides a low coefficient of friction for easier cable pulling. Flat design distributes the side-wall load and reduces duct burn-through. Marked with accurate sequential footage markings.

Part Number	Break Strength		Approx Width		Length	
	(lbs)	(N)	(in)	(mm)	(ft)	(m)
08096203	400	1,779	$\frac{1}{4}$	6	3,000	915
08096503	600	2,669	$\frac{3}{8}$	10	3,000	915
08075003	1,250	5,560	$\frac{1}{2}$	13	3,000	915
08075103	1,800	8,006	$\frac{5}{8}$	16	3,000	915
08096303	2,500	11,120	$\frac{3}{4}$	19	3,000	915



PULLING ROPE & PULLING TAPE



Polyester Pull Tape Pail

Designed for better mobility and faster deployment, pulling tape in a pail allows for moving from install to install without the hassle of carrying a tape stand.

Part Number	Break Strength		Approx Width		Length	
	(lbs)	(N)	(in)	(mm)	(ft)	(m)
08096001	400	1,779	1/4	6	4,500	1,372
08096003	1,800	8,006	5/8	16	1,300	396



Double-Braided Cable Pulling Rope

Premium quality rope recommended for cable pulling. Complete with spliced eye on each end. Double-braided construction offers high working loads and tensile strength without kinking. Contact factory for additional rope specifications.

Part Number	Diameter		Length		Break Strength	
	(in)	(mm)	(ft)	(m)	(lbs)	(N)
08091003	0.50	13	300	91	5,940	26,422
08091006	0.50	13	600	183	5,940	26,422
08091012	0.50	13	1,200	366	5,940	26,422
08090903	0.63	16	300	91	9,000	40,034
08090906	0.63	16	600	183	9,000	40,034
08090912	0.63	16	1,200	366	9,000	40,034
08091103	0.88	22	300	91	17,325	77,065
08091106	0.88	22	600	183	17,325	77,065
08091112	0.88	22	1,200	366	17,325	77,065



Pulling Tape

A flat woven replacement for 1/4" polypropylene rope that provides a lower coefficient of friction due to its flat woven design. Drastically reduces the chance of burn through that is associated with ropes, and has an elongation of less than 10% compared to Polypropylene rope which is 25%+. Not available printed.

Part Number	Break Strength		Approx. Width		Length	
	(lbs)	(N)	(in)	(mm)	(ft)	(m)
08099703	1,130	5,026	1/2	13	3,000	914





MANDRELS

Wood Test Mandrels

Pull through duct to prove joint integrity and test for out-of-round duct. 2,240 lbs. (9,964 N) load capacity. Wood body with steel end caps and pulling eyes.

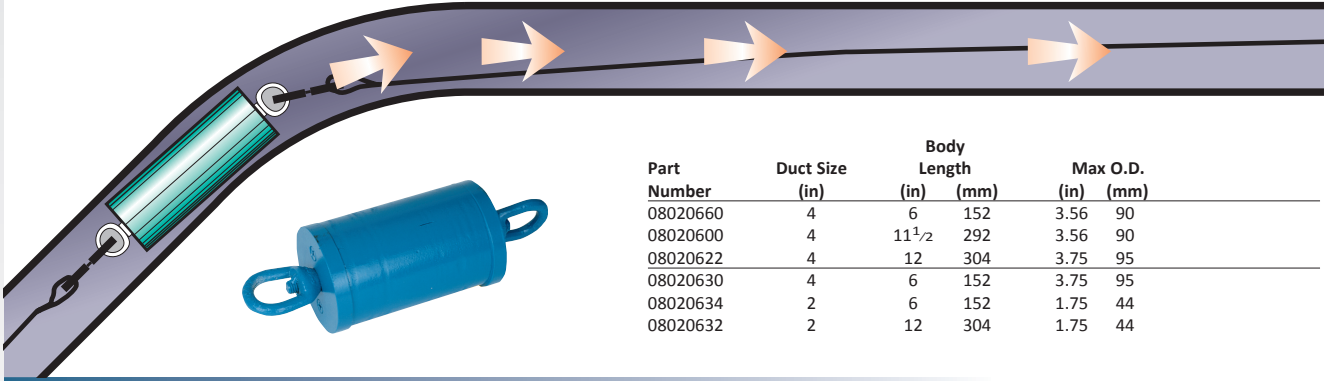

Part Number	Duct Size (in)	Body Length		Max O.D.	
		(in)	(mm)	(in)	(mm)
08020660	4	6	152	3.56	90
08020600	4	11 ¹ / ₂	292	3.56	90
08020622	4	12	304	3.75	95
08020630	4	6	152	3.75	95
08020634	2	6	152	1.75	44
08020632	2	12	304	1.75	44

Aluminum Test Mandrels

Pull through duct to prove joint integrity and test for out-of-round duct.

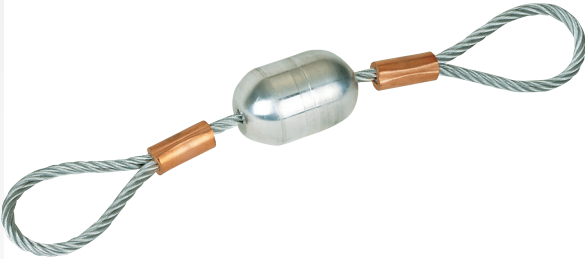

Part Number	Duct Size (in)	Body Length		Max O.D.		Load Capacity	
		(in)	(mm)	(in)	(mm)	(lbs)	(N)
08059515	1 ¹ / ₂	1.74	44	1.18	30	2,200	9,786
08059520	2	2.40	61	1.58	40	2,200	9,786
08059525	2 ¹ / ₂	2.98	76	1.95	50	2,200	9,786
08059530	3	3.54	90	2.33	59	2,200	9,786
08059535	3 ¹ / ₂	4.10	104	2.70	69	4,500	20,016
08059540	4	4.84	123	3.20	81	4,500	20,016
08059550	5	5.98	152	3.95	100	4,500	20,016
08059560	6	7.08	180	4.70	119	4,500	20,016
08059580	8	9.44	240	6.38	162	4,500	20,016

Aluminum Test Slugs

Pull through duct to prove joint integrity and test for out-of-round duct.

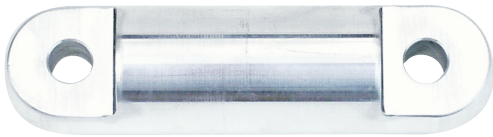

Part Number	Duct Size (in)	Body Length		Max O.D.		Load Capacity	
		(in)	(mm)	(in)	(mm)	(lbs)	(N)
08059005	1	1.71	43	0.860	22	2,200	9,786
08059015	1 ¹ / ₄	2.17	55	1.086	28	2,200	9,786
08059025	1 ¹ / ₂	2.49	63	1.243	32	2,200	9,786

Rubber Duct Swab

Ideal for cleaning and assisting in the spreading of lubricant throughout the duct. 7,000 lbs. (31,136 N) load capacity.

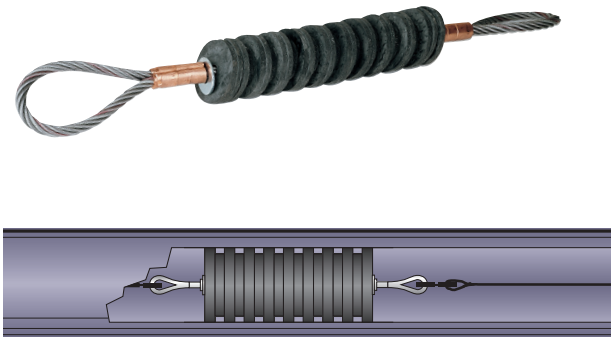

Part Number	Duct Size (in)	Body Length		Max O.D.	
		(in)	(mm)	(in)	(mm)
08028820*	2	10	254	2.00	51
08028830	3	10	254	3.00	76
08028700	3 ¹ / ₂	10	254	3.50	89
08028800	4	10	254	4.00	102
08058700	5	10	254	5.00	127
08058800	6	10	254	6.00	152
08022880	8	10	254	8.00	203

*4,500 lbs. (20,016 N) load capacity.



CONDEX

MANDRELS



FISHING & RODDING

Short Rubber Slug

For proving duct integrity and for spreading cable pulling lubricant especially in tight-radius bends. 4,500 lbs. (20,016 N) load capacity.

Part Number	Duct Size (in)	Body Length		Max O.D.	
		(in)	(mm)	(in)	(mm)
08082020	2	3.25	83	2.00	51
08082025	2½	3.25	83	2.50	64
08082030	3	3.25	83	3.00	76
08082035	3½	3.25	83	3.50	89
08082040	4	3.25	83	4.00	102
08082050	5	3.25	83	5.00	127
08082060	6	3.25	83	6.00	154
08082080	8	3.25	83	8.00	203



Wire Brush Mandrel

Flat steel bristles with a pulling eye on one end and a loop on the other end. Easily removes sand, grit and other light obstructions from the duct. 800 lbs. (3,558 N) load capacity.

Part Number	Duct Size (in)	Body Length		Overall Length		Max O.D.	
		(in)	(mm)	(in)	(mm)	(in)	(mm)
08028904	1¼	4.25	108	7.50	191	1.00	25
08028905	1½	4.25	108	7.50	191	1.25	32
08028900	2	4.25	108	9.16	232	1.75	44
08046000	2½	4.25	108	9.16	232	2.25	57
08067100	3	5.50	140	9.16	232	2.75	70
08067200	3½	5.00	127	9.16	232	3.25	82
08029000	4	6.75	171	9.16	232	3.75	95
08029100	5	6.50	165	9.16	232	4.75	121
08068100	6	6.75	171	9.16	232	5.75	146
08029080	8	4.75	121	9.73	247	7.75	197



08028904 & 08028905

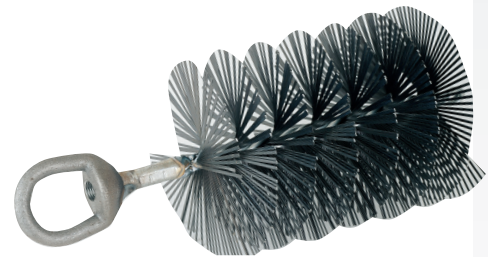

Heavy Duty Wire Brush Mandrels

Heavy-duty steel bristles with pulling eyes on each end. For removing obstructions from the duct.

Part Number	Duct Size (in)	Body Length		Max O.D.		Load	
		(in)	(mm)	(in)	(mm)	(lbs)	(N)
08900546	2	3.5	89	1.75	44	1,240	5,516
08900547	2½	4.25	108	2.25	57	1,240	5,516
08900548	3	5.25	133	2.75	70	1,240	5,516
08900549	3½	5.25	133	3.25	82	2,240	9,964
08900550	4	5.25	133	3.75	95	2,240	9,964
08900551	5	5.00	123	4.75	121	2,240	9,964
08900552	6	5.00	123	5.75	146	2,240	9,964
08900553	8	5.00	123	7.75	196	2,240	9,964



Flexible Steel Mandrel

Steel discs in graduated sizes make this mandrel ideal for removing obstructions in duct with extreme bends. 7,000 lbs. (31,136 N) load capacity.

Part Number	Duct Size (in)	Body Length		Max O.D.	
		(in)	(mm)	(in)	(mm)
08021700	2*	7.31	186	1.75	44
08021925	2½	11.25	286	2.25	57
08021800	3	11.25	286	2.75	70
08049400	3½	11.25	286	3.25	83
08067400	4 Sch 80	11.25	286	3.50	89
08021900	4	11.25	286	3.75	95
08067500	5 Sch 80	11.25	286	4.25	108
08058900	5	11.25	286	4.75	121
08067600	6 Sch 80	11.25	286	5.50	140
08059000	6	11.25	286	5.75	146
08079500	8	11.25	286	7.75	197

*2,000 lbs. (8,896 N) load capacity.

! When using the flexible steel mandrel there is the potential for duct shaving to occur.





BALL BEARING SWIVELS

808 Champion Swivels

Designed specifically for underground and overhead cable pulling applications. Can handle all types of utility cables. Precision machined from high-strength stainless steel. Clevis pin is easily replaceable (see ordering information below).

CAUTION: 808 Champion Swivels are to be used for cable stringing or pulling only. 808 Champion Swivels are not to be used for directional drilling.

NOTE: Swivels are not designed to run around bullwheels. Always verify that the swivel size is sized to the pulling harness or grip prior to ordering.

Not Designed for Directional Drilling.



! Not designed to be pulled around bullwheels or sheaves.

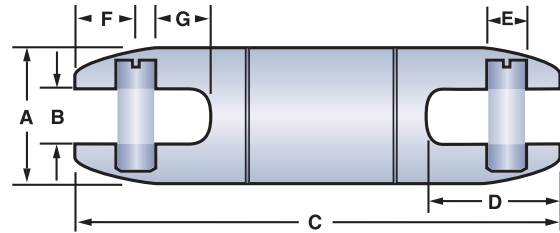

Part Number	WORKING LOAD				DIMENSIONS													
	*Underground		** Aerial		A		B		C		D		E		F		G	
	(LBS.)	(N)	(LBS.)	(N)	(IN.)	MM	(IN.)	MM	(IN.)	MM	(IN.)	MM	(IN.)	MM	(IN.)	MM	(IN.)	MM
08017000	600	2,669	360	1,601	5/8	16	.28	7	3.56	90	.80	20	.16	4	.37	9	.34	9
08016000	2,500	11,120	1,500	6,672	7/8	22	.38	10	4.41	112	1.03	26	.31	8	.53	13	.35	9
08016000H***	2,500	11,120	1,500	6,672	7/8	22	.38	10	4.41	112	1.03	26	.31	8	.53	13	.35	9
08080912	5,000	22,241	3,000	13,344	1-1/4	32	.56	14	5.44	138	1.34	34	.37	9	.59	15	.57	14
08080912H***	5,000	22,241	3,000	13,344	1-1/4	32	.56	14	5.44	138	1.34	34	.37	9	.59	15	.57	14
08080913	7,000	31,137	4,200	18,682	1-3/8	35	.56	14	5.25	133	1.31	33	.43	11	.56	14	.54	14
08080913H***	7,000	31,137	4,200	18,682	1-3/8	35	.56	14	5.25	133	1.31	33	.43	11	.56	14	.54	14
08080916	10,000	44,482	6,000	26,689	1-5/8	41	.63	16	6.51	165	1.59	40	.56	14	.78	20	.54	14
08080916H***	10,000	44,482	6,000	26,689	1-5/8	41	.63	16	6.51	165	1.59	40	.56	14	.78	20	.54	14
08080920	15,000	66,723	9,000	40,033	2	51	.75	19	6.99	178	1.78	45	.62	16	.72	18	.75	19
08080920H***	15,000	66,723	9,000	40,033	2	51	.75	19	6.99	178	1.78	45	.62	16	.72	18	.75	19
08080925	25,000	111,205	15,000	66,723	2-1/2	64	1.00	25	10.20	259	2.80	71	.87	22	1.23	31	1.13	29
08080925H***	25,000	111,205	15,000	66,723	2-1/2	64	1.00	25	10.20	259	2.80	71	.87	22	1.23	31	1.13	29
08080930	30,000	133,446	18,000	80,068	3	76	1.31	33	12.04	306	3.56	90	1.12	28	1.38	35	1.60	41

* 3:1 Safety Factor

** 5:1 Safety Factor

*** Comes standard with hex head clevis pin

Replacement Clevis Pins for 808 Champion Swivels

Part Number	Replacement Part Number, Slotted Pin	Part Number	Replacement Part Number, Hex Pin
08017000	08017016		
08016000	08955408	08016000H	08081065
08080912	08081046	08080912H	08081042
08080913	08081036	08080913H	21000371
08080916	08081026	08080916H	21000381
08080920	08081016	08080920H	21000391
08080925	08081006	08080925H	21000401
08080930	08081053		



BALL BEARING SWIVELS



821 Champion Swivels

Designed to meet common dimensional specifications, the 821 Champion Swivels are designed for underground and overhead cable pulling applications and can handle all types of utility cable. Precision machined stainless steel. Clevis pin is easily replaceable (see ordering information below).

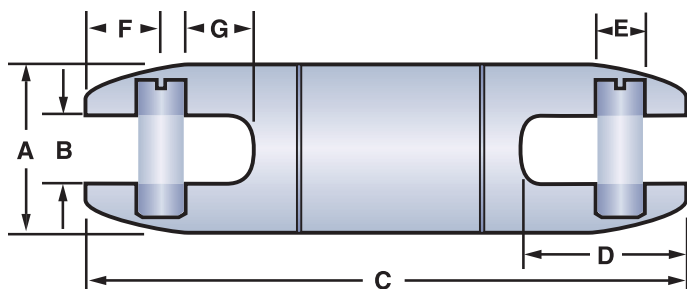

! Not designed to be pulled around bullwheels or sheaves.

Part Number	WORKING LOAD				DIMENSIONS													
	*Underground		** Aerial		A		B		C		D		E		F		G	
	(LBS.)	(N)	(LBS.)	(N)	(IN.)	MM	(IN.)	MM	(IN.)	MM	(IN.)	MM	(IN.)	MM	(IN.)	MM	(IN.)	MM
08210007	1800	8006	1080	4804	0.875	22	0.31	8	3.09	78	0.84	21	0.31	8	0.38	10	0.31	8
08210012	4000	17792	2400	10675	1.25	32	0.59	15	4.52	115	1.22	31	0.37	9	0.44	11	0.60	15
08210014	7500	33360	4500	20016	1.44	37	0.59	15	5.47	139	1.41	36	0.43	11	0.59	15	0.60	15
08210018	10000	44480	6000	26689	1.88	48	0.75	19	7.07	179	1.86	47	0.62	16	0.80	20	0.76	19

* 3:1 Safety Factor
**5:1 Safety Factor

Replacement Clevis Pins for 821 Champion Swivels

Part Number	Replacement Part Number, Slotted Pin
08210007	08210105
08210012	08210115
08210014	08210125
08210018	08210135

SWIVELS & ACCESSORIES





SWIVEL ACCESSORIES

Rope to Swivel Clevis

Used to connect the swivel to rope up to 1" (25 mm) in diameter. To be used with 1 1/4" (32 mm), 1 3/8" (35 mm), 1 5/8" (41 mm) & 2" (51 mm) 808 Champion Swivels. Precision machined stainless steel.

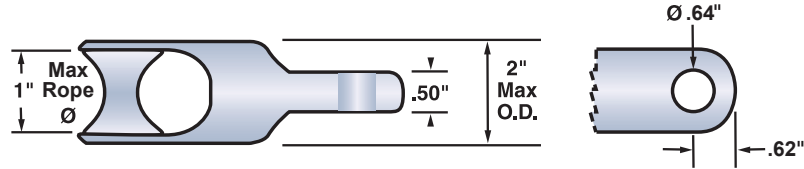

Part Number	Swivel Size		Max O.D.		Load Rating		Replacement Roller	Replacement Pin
	(in)	(mm)	(in)	(mm)	(lbs)	(N)	Part Number	Part Number
08091230	1 1/4-2	32-51	2	51	10,000	44,480	08091221	08091222

Rope to Rope/Grip Clevis

Versatile clevis provides efficient link for several applications. Stainless steel construction. Combinations of sheaves and pins allow the following connections:

- Rope to rope
- Rope to forged eye pulling grip
- Forged eye pulling grip to forged eye pulling grip
- Rope to flexible eye pulling grip

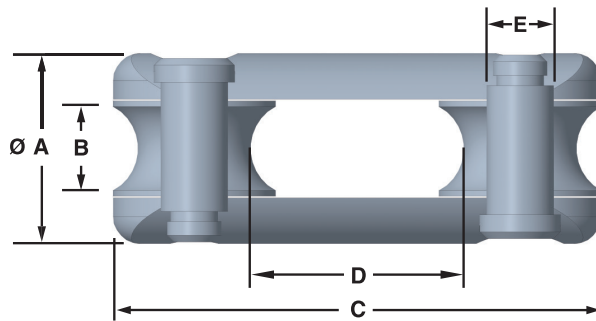

Part Number	FOR MAX ROPE Ø		DIMENSIONS										Replacement Roller Part Number	Replacement Pin Part Number	Load Capacity	
	(IN.)	MM	A (IN.)	A (MM)	B (IN.)	B (MM)	C (IN.)	C (MM)	D (IN.)	D (MM)	E (IN.)	E (MM)			(lbs)	(N)
08091205	1/2	13	1.00	25	0.53	13	2.00	51	0.78	20	0.25	6	08091208	08091206	1,000	4,448
08091200	7/8	22	1.75	44	0.91	23	4.50	114	1.96	50	0.62	16	08091202	08091201	10,000	44,482



SWIVEL ACCESSORIES



SWIVELS & ACCESSORIES

SWIVEL COMPATIBILITY CHART							
Part Number	Swivel Size (in) (mm)		Pulling Eye Size Range			Pulling Harnesses	
			Standard Head Reusable Power Pulling Eyes Cable Size	Fixed Head Innerduct Pulling Eyes (Part Number)	Eye to Eye Connectors Size (Part Number)	Separate Leg Ends	Large Front Link Size (Part Number)
08017000	5/8	16	-	-	-	1/8", 1/4"	-
08016000	7/8	22	-	-	-	1/8", 1/4"	-
08080912	1-1/4	32	1/0 AWG - 250 kcmil	08914110, 08914120, 08914130, 08914140	(3/8") 08050300 (1/2") 08050500	All	(1/8"-08549200) (1/4"-08549230, 08549325, 08569910, 08549326) (1/2"-08549331)
08080913	1-3/8	35	1/0 AWG - 250 kcmil	08914110, 08914120, 08914130, 08914140	(3/8") 08050300	All	(1/8"-08549200) (1/4"-08549230, 08549325, 08569910, 08549326) (1/2"-08549331)
08080916	1-5/8	41	-	-	(3/8") 08050300 (1/2") 08050500	All	(1/8"-08549200) (1/4"-08549230, 08549325, 08569910, 08549326) (1/2"-08549331)
08080920	2	51	350 kcmil - 1,000 kcmil	-	All	All	(1/8"-08549200) (1/4"-08549230, 08549325, 08569910, 08549326) (1/2"-08549331)
08080925	2-1/2	64	1250 kcmil - 3,000 kcmil	-	(1/2") 08050500 (5/8") 08050501	All Cables	All
08080930	3	76	-	-	(1/2") 08050500 (5/8") 08050501	All Cables	All
08210007	7/8	22	-	-	-	1/8", 1/4"	-
08210012	1-1/4	32	1/0 AWG - 250 kcmil	All	(3/8") 08050300 (1/2") 08050500	All	(1/8"-08549200) (1/4"-08549230, 08549325, 08569910, 08549326) (1/2"-08549331)
08210014	1-7/16	37	1/0 AWG - 250 kcmil	All	(3/8") 08050300 (1/2") 08050500	All	(1/8"-08549200) (1/4"-08549230, 08549325, 08569910, 08549326) (1/2"-08549331)
08210018	1-7/8	48	350 kcmil - 1,000 kcmil	-	All	All	(1/8"-08549200) (1/4"-08549230, 08549325, 08569910, 08549326) (3/8"-08549333, 08549329) (1/2"-08549331)





BREAK-AWAY SWIVELS



! The 10% break tolerance zone for pins used in 5/8" (16 mm) and 7/8" (22 mm) diameter break-away swivels is + / - 5% of the nominal break load, called out along with the swivel diameter, in the description of the pin.

Break-Away Swivels

Essential for fiber optic and coaxial cable pulling, these swivels have a break load ranging from 150–1,800 pounds (667–8,006 N) and are designed to separate at ±5% of their rated break load. If the load rating is exceeded, the interior break pin fractures, the swivel separates, and the cable remains undamaged. Break pin is easily replaceable (see ordering information, next page).

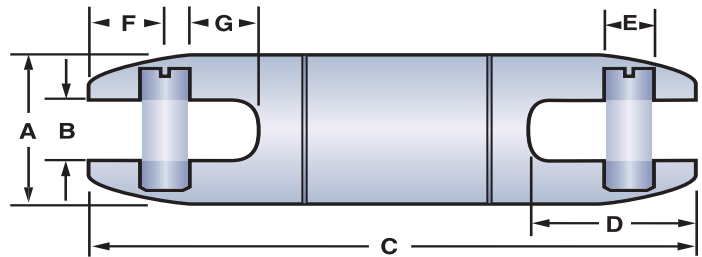

NOTE: Swivels are not designed to run around bullwheels.

Part Number	Break Load		DIMENSIONS														
	(LBS.)	(N)	A (IN.)	MM	B (IN.)	MM	C (IN.)	MM	D (IN.)	MM	E (IN.)	MM	F (IN.)	MM	G (IN.)	MM	
5/8 Swivels	08017300	200	890	5/8	16	.28	7	3.56	90	.80	20	.16	4	.37	9	.34	9
	08017400	250	1,112	5/8	16	.28	7	3.56	90	.80	20	.16	4	.37	9	.34	9
	08016900	450	2,002	5/8	16	.28	7	3.56	90	.80	20	.16	4	.37	9	.34	9
	08017200	600	2,669	5/8	16	.28	7	3.56	90	.80	20	.16	4	.37	9	.34	9
	08017500	650	2,891	5/8	16	.28	7	3.56	90	.80	20	.16	4	.37	9	.34	9
	08017900	750	3,336	5/8	16	.28	7	3.56	90	.80	20	.16	4	.37	9	.34	9
7/8 Swivels	08018100	150	667	7/8	22	.38	10	4.41	112	1.03	26	.31	8	.53	13	.35	9
	08018300	200	890	7/8	22	.38	10	4.41	112	1.03	26	.31	8	.53	13	.35	9
	08018000	250	1,112	7/8	22	.38	10	4.41	112	1.03	26	.31	8	.53	13	.35	9
	08017600	300	1,334	7/8	22	.38	10	4.41	112	1.03	26	.31	8	.53	13	.35	9
	08018400	350	1,557	7/8	22	.38	10	4.41	112	1.03	26	.31	8	.53	13	.35	9
	08075300	400	1,779	7/8	22	.38	10	4.41	112	1.03	26	.31	8	.53	13	.35	9
	08015800	450	2,002	7/8	22	.38	10	4.41	112	1.03	26	.31	8	.53	13	.35	9
	08076500	500	2,224	7/8	22	.38	10	4.41	112	1.03	26	.31	8	.53	13	.35	9
	08018500	550	2,446	7/8	22	.38	10	4.41	112	1.03	26	.31	8	.53	13	.35	9
	08015000	600	2,669	7/8	22	.38	10	4.41	112	1.03	26	.31	8	.53	13	.35	9
	08018600	650	2,891	7/8	22	.38	10	4.41	112	1.03	26	.31	8	.53	13	.35	9
	08076000	700	3,114	7/8	22	.38	10	4.41	112	1.03	26	.31	8	.53	13	.35	9
	08075500	750	3,336	7/8	22	.38	10	4.41	112	1.03	26	.31	8	.53	13	.35	9
	08018700	800	3,558	7/8	22	.38	10	4.41	112	1.03	26	.31	8	.53	13	.35	9
	08018800	850	3,781	7/8	22	.38	10	4.41	112	1.03	26	.31	8	.53	13	.35	9
	08076600	900	4,003	7/8	22	.38	10	4.41	112	1.03	26	.31	8	.53	13	.35	9
	08015700	1,000	4,448	7/8	22	.38	10	4.41	112	1.03	26	.31	8	.53	13	.35	9
	08018900	1,100	4,893	7/8	22	.38	10	4.41	112	1.03	26	.31	8	.53	13	.35	9
	08015200	1,200	5,338	7/8	22	.38	10	4.41	112	1.03	26	.31	8	.53	13	.35	9
	08019100	1,300	5,782	7/8	22	.38	10	4.41	112	1.03	26	.31	8	.53	13	.35	9
08074600	1,400	6,227	7/8	22	.38	10	4.41	112	1.03	26	.31	8	.53	13	.35	9	
08076900	1,500	6,672	7/8	22	.38	10	4.41	112	1.03	26	.31	8	.53	13	.35	9	
08019200	1,600	7,117	7/8	22	.38	10	4.41	112	1.03	26	.31	8	.53	13	.35	9	
08019300	1,700	7,562	7/8	22	.38	10	4.41	112	1.03	26	.31	8	.53	13	.35	9	
08017700	1,800	8,006	7/8	22	.38	10	4.41	112	1.03	26	.31	8	.53	13	.35	9	



BREAK-AWAY SWIVELS



Replacement Pins

Break pins for Condux Break-Away Swivels are easy to order and ready to ship.

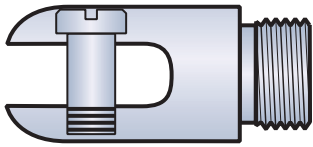

Externally Threaded Head



Break Pin



Bearings

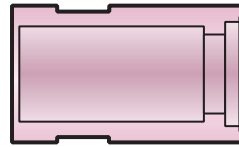

Body

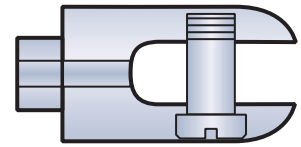

Internally Threaded Head

REPLACEMENT PINS				
	Part Number	Break Load		Pin Color
		(LBS.)	(N)	
5/8 Swivels	08017306	200	890	Green/ Black
	08017406	250	1,112	Blue/White
	08016905	450	2,002	Blue/Yellow
	08017205	600	2,669	Orange/Black
	08017505	650	2,891	Brown/White
	08017905	750	3,336	Orange/Violet
7/8 Swivels	08018106	150	667	White
	08018306	200	890	Green
	08018006	250	1,112	Blue
	08017606	300	1,334	Brown
	08018405	350	1,557	Black/Green
	08075305	400	1,779	Blue/Black
	08015805	450	2,002	Blue/Yellow
	08076505	500	2,224	Orange/Red
	08018505	550	2,446	Blue/Green
	08015005	600	2,669	Orange/Black
	08018605	650	2,891	Slate/Green
	08076005	700	3,114	Orange/White
	08075505	750	3,336	Orange/Violet
	08018705	800	3,558	Red/Yellow
	08018805	850	3,781	Black/Yellow
	08076605	900	4,003	Orange/Yellow
	08015705	1,000	4,448	Green/White
	08018905	1,100	4,893	White/Yellow
	08015205	1,200	5,338	Brown/White
	08019105	1,300	5,782	Brown/Yellow
08074605	1,400	6,227	Green/Red	
08076905	1,500	6,672	Green/Yellow	
08019205	1,600	7,117	Black/White	
08019305	1,700	7,562	Red/White	
08017705	1,800	8,006	Brown/Black	





PULLING ACCESSORIES

SWIVELS & ACCESSORIES

Threaded Chain Connectors

Offers a quick and easy way to connect pulling eyes or swivels to winch lines, harnesses or rope. To close, simply screw the nut onto the threaded end. Connectors are reusable.

Note: To be used for cable stringing or pulling only.

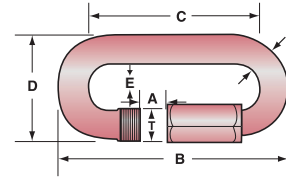

Part Number	Working Load Limit		Stock Diameter (S)		Threaded Shaft (T)		Opening Width (A)		Length (B)		Inside Length (C)		Width (D)		Inside Width (E)	
	(LBS.)	(N)	(IN)	(MM)	(IN)	(MM)	(IN)	(MM)	(IN)	(MM)	(IN)	(MM)	(IN)	(MM)	(IN)	(MM)
08581212	200	890	0.125	3.2	0.20	5	0.375	9.5	1.813	46.0	1.563	40	0.79	20	.37	9.4
08581218	550	2,446	0.188	4.8	0.27	7	0.500	12.7	2.438	61.9	2.063	52	1.06	27	.54	13.7
08581225	770	3,425	0.250	6.4	0.35	9	0.563	14.3	2.750	69.9	2.313	59	1.17	30	.52	13.2
08581231	1,430	6,361	0.313	7.9	0.43	11	0.688	17.5	3.438	87.3	2.813	71	1.57	40	.69	17.5
08581237	1,760	7,828	0.375	9.5	0.47	12	0.750	19.1	3.750	95.3	3.000	76	1.68	43	.74	18.8
08581250	2,755	12,254	0.500	12.7	0.60	15	0.938	23.8	4.875	123.8	3.938	100	2.16	55	.89	22.6
08581256	4,410	19,616	0.563	14.3	0.67	17	1.063	27.0	5.563	141.3	4.500	114	2.39	61	1.00	25.4
08581262	5,510	24,508	0.625	15.9	0.74	19	1.125	28.6	6.313	160.3	5.063	129	2.73	69	1.13	28.7
08581268	6,615	29,424	0.688	17.5	0.86	22	1.250	31.8	6.938	176.2	5.500	140	3.04	77	1.20	30.5
08581278	7,935	35,295	0.781	19.8	0.93	24	1.375	34.9	7.813	198.4	6.250	159	3.33	85	1.34	34.0

THREADED CHAIN CONNECTOR COMPATIBILITY CHART

Chain Connector Part Number	Size (in) (mm)		Pulling Eye Size Range		Pulling Harnesses		
			Standard Head Reusable Power Pulling Eyes Cable Size	Fixed Head Innerduct Pulling Eyes	Eye to Eye Connectors Size	Separate Leg Ends	Large Front Link Size
08581212	1/8	3	-	-	-	1/8", 1/4"	-
08581218	3/16	5	1/0 - 500 kcmil	All	3/8" (10 mm)	1/8", 1/4", 3/8"	1/8" (3 mm)
08581225	1/4	6	1/0 - 500 kcmil	All	3/8" (10 mm), 1/2" (13 mm)	1/8", 1/4", 3/8"	1/8" (3 mm)
08581231	5/16	8	600 kcmil - 1000 kcmil	All	All	All Cable	1/8" (3 mm), 3 x 1/4" (6 mm), 2 x 1/2" (13 mm), Chain
08581237	3/8	10	-	All	All	All Cable	1/8" (3 mm), 3 & 4 x 3/8" (10 mm), 2 x 1/2" (13 mm), Chain
08581250	1/2	13	1,250 kcmil - 2,000 kcmil	-	All	All	All
08581256	9/16	14	2,000 - 3,000 kcmil	-	All	All	All
08581262	5/8	16	2,500 - 3,000 kcmil	-	All	All	All
08581268	11/16	17	-	-	All	All	All
08581278	7/8	22	-	-	All	All	All

Eye to Eye Connectors

Light duty winch line pulling connector drop forged from C-1035 steel. Hot dip galvanized.



Part Number	Size		Working Load	
	(IN)	(MM)	(LBS)	(N)
08050300	3/8	10	2,200	9,786
08050500	1/2	13	3,600	16,013
08050501	5/8	16	5,200	23,130

NOTE: To be used for cable stringing or pulling only.



CONDEX

PULLING ACCESSORIES



SWIVELS & ACCESSORIES

Multiple Pulling Harness

Allows staggered attachment to cable or innerduct when pulling through conduit systems or during directional drilling pull-back operations. Note: 10 & 12 Way 3/8" (10 mm) harnesses only have a single stagger. All other harnesses are sequentially staggered.

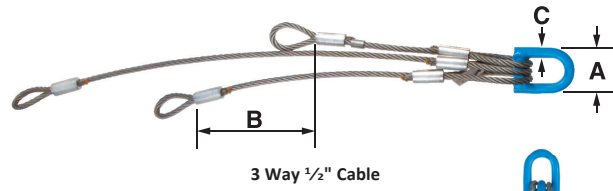

3 Way 1/2" Cable



4 Way 3/8" Cable

Part Number	Description	Working Load Per Leg		Working Load Combined		Max Width (A)		Separation Between Legs (B)		Lead Ring Diameter (C)	
		(LBS.)	(N)	(LBS.)	(N)	(IN)	(MM)	(IN)	(MM)	(IN)	(MM)
08549200	3 Way 1/8" (3 mm) Cable	660	2,936	1,800	8,009	2.25	57	14	356	.37	9
08549230	3 Way 1/4" (6 mm) Cable	1,170	5,204	3,000	13,345	1.63	41	14	356	.37	9
08549325	4 Way 1/4" (6 mm) Cable	1,170	5,204	3,000	13,345	1.63	41	14	356	.37	9
08569910	5 Way 1/4" (6 mm) Cable	1,170	5,204	3,000	13,345	1.63	41	14	356	.37	9
08549326	6 Way 1/4" (6 mm) Cable	1,170	5,204	3,000	13,345	1.63	41	14	356	.37	9
08549333	3 Way 3/8" (10 mm) Cable	4,800	21,351	9,000	40,032	2.63	67	10	254	.62	16
08549329	4 Way 3/8" (10 mm) Cable	4,800	21,351	9,000	40,032	2.63	67	10	254	.62	16
08549330	10 Way 3/8" (10 mm) Cable	2,400	10,676	6,000	26,689	4.50	114	6	152	.75	19
08549334	12 Way 3/8" (10 mm) Cable	2,400	10,676	6,000	26,689	4.50	114	6	152	.75	19
08549331	2 Way 1/2" (13 mm) Cable	8,000	35,586	8,000	35,586	2.50	64	12	305	.50	13
08549332	3 Way 1/2" (13 mm) Cable	8,000	35,586	15,000	66,720	3.75	95	12	305	.87	22
08549340	4 Way 1/2" (13 mm) Cable	8,000	35,586	15,000	66,720	3.75	95	12	305	.87	22



See Swivel Compatibility Chart on page 37 to match up your multiple pulling harness with your swivels.

Multiple Pulling Harness for Micro Duct Installation

Six leg harness with swivel and 3-inch separation between legs for installing micro duct into existing innerduct.



Part Number	Description	Load Rating
08549350	Multiple Pulling Harness	550 lbs (2,446 N)

Figure 8 Swing Links

For quick connections to winch line or pulling harnesses.

Note: To be used for cable stringing or pulling only.

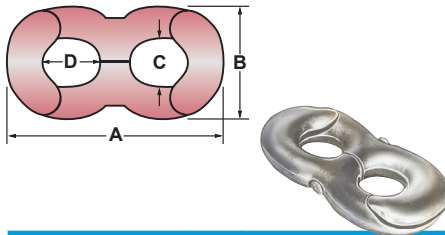

Part Number	Size		Working Load		Length (A)		Width (B)		Eye ID (C)		Eye ID (D)	
	(IN)	(MM)	(LBS.)	(N)	(IN)	(MM)	(IN)	(MM)	(IN)	(MM)	(IN)	(MM)
08580825	1/4	6	1,000	4,448	1.94	49	.94	24	.38	10	.50	13
08580837	3/8	10	1,700	7,561	2.90	74	1.31	33	.50	13	.63	16
08580850	1/2	13	6,000	26,689	3.25	83	1.63	41	.69	18	.75	19
08580875	3/4"	19	10,000	44,482	5.00	127	2.50	64	.94	24	1.13	29
08580899	1	25	22,000	97,860	6.50	165	3.25	83	1.25	32	1.50	38

SWING LINK COMPATIBILITY CHART							
Swing Link Part Number	Size (in) (mm)		Pulling Eye Size Range		Eye to Eye Connectors Size	Pulling Harnesses	
			Standard Head Reusable Power Pulling Eyes Cable Size			Separate Leg Ends	Large Front Link Size
08580825	1/4	6	-		-	1/8" (3 mm), 1/4" (6 mm)	-
08580837	3/8	10	1/0 AWG - 250 kcmil		3/8" (10 mm)	1/8" (3 mm), 1/4" (6 mm), 3/8" (10 mm), Chain	-
08580850	1/2	13	350 kcmil - 1,000 kcmil		3/8" (10 mm), 1/2" (13 mm)	All Cable	2 x 1/2" (13 mm)
08580875	3/4	19	1250 kcmil - 2000 kcmil		All	All Cable	1/8" (3 mm), 1/4" (6 mm), 3/8" (10 mm), 2 x 1/2" (13 mm), Chain
08580899	1	25	-		1/2" (13 mm), 5/8" (16 mm)	All Cable	All





DIRECTIONAL DRILLING SWIVELS

819 D.Drill Directional Drilling Swivels

Designed specifically for directional drilling, the Condux 819 D.Drill Swivels prevent boring equipments' rotational torque from interfering with the product (cable or conduit) being pulled. The D.Drill Swivels are greasable and double sealed to keep contaminants out. Clevis pins with hex nuts allow for installation and removal from either side of the swivel. Condux Directional Drilling Swivels feature a 90 day warranty.

CAUTION: To be used for directional drilling only.

CAUTION: Condux requires the use of a calcium based lubricant only. Other lubricants may have adverse reactions when exposed to bentonite products. Condux requires that the swivels be greased after each use to purge any contaminants that may have penetrated past the seals into the swivel while boring. See page 43 for calcium based lubricants.

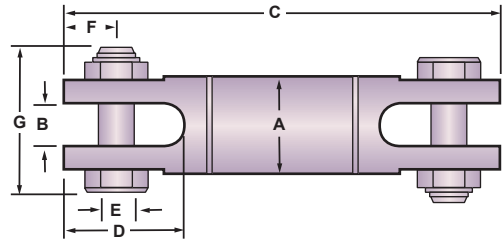

Part Number	Working Load				A		B		C		D		E		F		G	
	Tension		Compression															
	(LBS)	(N)	(LBS)	(N)	(IN)	(MM)	(IN)	(MM)	(IN)	(MM)	(IN)	(MM)	(IN)	(MM)	(IN)	(MM)	(IN)	(MM)
08190016	8,500	37,808	2,800	12,454	1-5/8"	41	.63	16	6.86	174	1.59	40	.56	14	.78	20	2.36	60
08190020	10,000	44,480	3,300	14,678	2"	51	.75	19	7.86	200	1.81	46	.63	16	.75	19	2.89	73
08190025	20,000	88,960	6,600	29,357	2-1/2"	64	1.00	25	10.94	278	2.84	72	.88	22	1.25	32	3.67	93
08190030	30,000	133,440	10,000	44,480	3"	76	1.31	33	12.77	324	3.56	90	1.13	29	1.38	35	4.50	114
08190040	45,000	200,160	15,000	66,720	4"	102	1.63	41	15.25	387	4.00	102	1.25	32	1.88	48	5.58	142
08190045	60,000	266,880	20,000	88,960	4-5/8"	117	1.75	44	17.48	444	4.63	118	1.50	38	2.13	54	6.31	160
08190060	90,000	400,320	30,000	133,440	6"	152	2.00	51	18.27	464	4.50	114	1.75	44	2.19	56	6.59	167
08190080	120,000	533,760	40,000	177,920	7-3/4"	197	2.25	57	21.72	552	5.25	133	2.00	51	2.50	64	8.25	210

400 D.Drill® Directional Drilling Swivels

Designed specifically for directional drilling, the Condux 400 D.Drill Swivels prevent boring equipments' rotational torque from interfering with the product (cable or conduit) being pulled. The D.Drill Swivels are greasable and double sealed to keep contaminants out. Condux Directional Drilling Swivels feature a 90 day warranty.

CAUTION: To be used for directional drilling and underground cable installation only.

CAUTION: Condux requires the use of a calcium based lubricant only. Other lubricants may have adverse reactions when exposed to bentonite products. Condux requires that the swivels be greased after each use to purge any contaminants that may have penetrated past the seals into the swivel while boring.

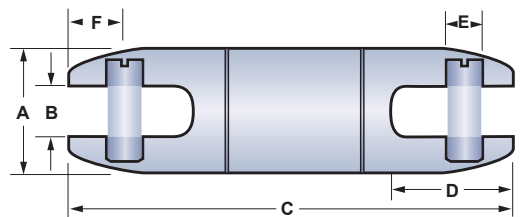

Part Number	Working Load				A		B		C		D		E		F	
	Tension		Compression													
	(LBS)	(N)	(LBS)	(N)	(IN)	(MM)	(IN)	(MM)	(IN)	(MM)	(IN)	(MM)	(IN)	(MM)	(IN)	(MM)
08190408	1,800	6,588	595	2,177	7/8"	22	.38	10	4.83	123	1.03	26	.31	8	.53	13
08190412	4,000	14,641	1,300	4,758	1-1/4"	32	.56	14	6.57	167	1.34	34	.37	9	.59	15
08190416	8,500	37,808	2,800	12,454	1-5/8"	41	.63	16	7.22	183	1.59	40	.56	14	.78	20
08190421	10,000	44,480	3,300	14,678	2"	51	.75	19	8.68	220	2.00	51	.62	16	.82	21
08190426	20,000	88,960	6,600	29,357	2-1/2"	64	1.00	25	11.44	291	2.80	71	.87	22	1.23	31
08190431	30,000	133,440	10,000	44,480	3"	76	1.31	33	13.27	337	3.56	90	1.12	28	1.38	35



DIRECTIONAL DRILLING SWIVELS



819 D.Drill® Replacement Parts

Part Number	Clevis Pin	Locking Nut
08190016	08190104	02250500
08190020	08190114	02250600
08190025	08190124	02250700
08190030	08190134	02250800
08190040	08190154	02263000
08190045	08190144	02250900
08190060	08190164	02251000
08190080	08190167	02279000



400 D.Drill® Replacement Parts

Part Number	Clevis Pin
08190408	08081065
08190412	08081042
08190416	21000381
08190421	08190542
08190426	08190547
08190431	08190552



D.Drill® Grease

Specially formulated for use in a bentonite clay environment. This is an extreme pressure multiservice lubricant designed to give outstanding performance in directional drilling/boring applications. Manufactured from the highest quality petroleum oil and thickened with a unique calcium complex soap. This thickener resists breakdown caused by bentonite, which is common with lithium based lubricants. Packaged in cartridges to fit a standard grease gun.

Part Number	Description
08190007	Directional Drilling Grease (1 Cartridge)





DIRECTIONAL DRILLING SWIVELS

Break-Away Swivels for Directional Drilling

Avoid overstressing cable or conduit being pulled in during directional drilling operations. The Condux Break-Away Swivels for directional drilling are designed exclusively to provide both the swivel and the break link for product pull-back. Eliminate the use of two or more components and shorten the gap between the reamer and pulling eye. No need to use "weak link" pipe sections or wire when using the Condux Break-Away Swivel.

Six different diameter swivels are available to accommodate various pulling needs. Break loads range from 1,200 lbs. (5,338 N) to 40,000 lbs. (111,250 N) and are designed to separate at +8/-2% of their rated break load. Order Replacement Pins as needed.

NOTE: D.Drill Swivels come with a 90 day limited warranty.

Condux Break-Away DDrill® Swivels are designed for use when directional drilling; however, they may be used in other applications where the swivel, product and pulling medium are segregated from personnel and a break would remain contained (a pipe or bore hole).

WARNING: Use in any manner other than that described above could result in severe personal injury or death.



Break-Away D.Drill® Swivel
1-1/4"-1-5/8" (32 mm - 41 mm)



Break-Away D.Drill® Swivel
2"-4" (51 mm - 102 mm)

Part Number	Break Load		Replacement Pin	
	(LBS.)	(N)	Part Number	Color
1-1/4" Swivel (32 mm)				
08021210	1,200	5,338	08021215	Brown/White
08021280	1,500	6,672	08021285	Green/Yellow
08021220	1,900	8,451	08021225	Violet/Black
08021230	2,000	8,896	08021235	Slate/White
08021240	2,500	11,120	08021245	Violet/Green
08021250	3,000	13,344	08021255	Slate/Red
08021260	3,400	15,123	08021265	Blue/Yellow
08021270	4,000	17,792	08021275	Red/Yellow
1-5/8" Swivel (41 mm)				
08021610	4,500	20,017	08021615	Slate/Yellow
08021620	5,000	22,241	08021625	Orange/Blue
08021630	5,500	24,465	08021635	Brown/Green
08021640	6,000	26,689	08021645	Blue/Brown
08021650	6,500	28,913	08021655	Red/Blue
08021660	7,000	31,136	08024505	Orange
08021670	7,500	33,360	08025505	Blue
08021680	8,000	35,584	08027905	Yellow
08021690	8,500	37,808	08028405	Slate

Part Number	Break Load		Replacement Pin	
	(LBS.)	(N)	Part Number	Color
2" Swivel (51 mm)				
08029200	9,000	40,032	08029205	Red
08029400	10,000	44,480	08029405	Green
2-1/2" Swivel (64 mm)				
08029600	12,000	53,376	08029605	White
08029700	14,000	62,272	08029705	Brown
3" Swivel (76 mm)				
08075600	18,500	82,288	08029720	Black
08075800	22,000	97,856	08075805	Yellow
08075820	25,000	111,250	08075825	Blue
4" Swivel (102 mm)				
08075940	40,000	177,928	08075945	Orange

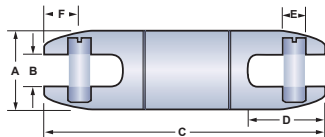
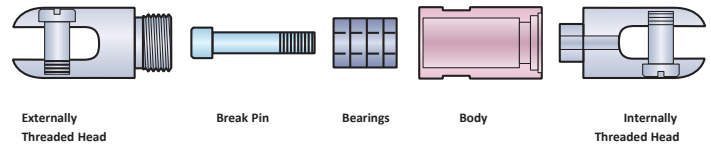

Use these dimensions when ordering the 1-1/4" (32 mm), and the 1-5/8" (41 mm) swivels.

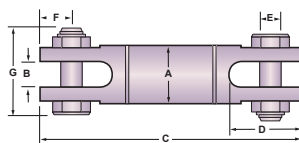

Use these dimensions when ordering the 2" (51 mm), the 2-1/2" (64 mm), the 3" (76 mm), and the 4" (102 mm) swivels.

Break-Away Swivel Dimensions

	A		B		C		D		E		F		G	
	(IN)	(MM)	(IN)	(MM)	(IN)	(MM)	(IN)	(MM)	(IN)	(MM)	(IN)	(MM)	(IN)	(MM)
1-1/4	32	.56	14	6.57	167	1.34	34	.37	9	.59	15	-	-	
1-5/8	41	.63	16	7.22	183	1.59	40	.56	14	.78	20	-	-	
2	51	.75	19	7.86	200	1.81	46	.63	16	.75	19	2.89	73	
2-1/2	64	1.00	25	10.94	278	2.84	72	.88	22	1.25	32	3.67	93	
3	76	1.31	33	12.77	324	3.56	90	1.13	29	1.38	35	4.50	114	
4	102	1.63	41	15.25	387	4.00	102	1.25	32	1.88	48	5.58	142	



DIRECTIONAL DRILLING SWIVELS



7/8" (22 mm) Break-Away Swivels for Directional Drilling

Avoid overstressing cable or conduit being pulled in during directional drilling operations. The Condux 7/8" (22 mm) Break-Away Swivel for directional drilling is designed exclusively to provide both the swivel and the break link for product pull-back. Eliminate the use of two or more components and shorten the gap between the reamer and pulling eye. No need to use "weak link" pipe sections or wire when using the 7/8" (22 mm) Condux Break-Away Swivel.

This swivel is available to accommodate various pulling needs. Break loads range from 150 lbs. (667 N) to 1,800 lbs. (8,006 N) and are designed to separate at ±5% of their rated break load. Order Replacement Pins as needed.

NOTE: D.Drill Swivels come with a 90 day limited warranty.

***WARNING:** This swivel is to be used while Directional Drilling only— Severe personal injury could result if used with rope or steel winch lines in cable pulling applications.

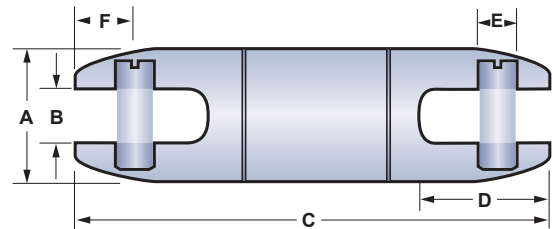

7/8" Break-Away Swivel Dimensions											
A		B		C		D		E		F	
(IN)	(MM)	(IN)	(MM)	(IN)	(MM)	(IN)	(MM)	(IN)	(MM)	(IN)	(MM)
7/8	22	.38	10	4.83	123	1.03	26	.31	8	.53	13

Part Number	Break Load		Replacement Pin	
	(LBS.)	(N)	Part Number	Color
7/8" Swivel (22 mm)				
08021015	150	667	08018106	White
08021020	200	890	08018306	Green
08021025	250	1,112	08018006	Blue
08021030	300	1,334	08017606	Brown
08021035	350	1,557	08018405	Black/Green
08021040	400	1,779	08075305	Blue/Black
08021045	450	2,002	08015805	Blue/Yellow
08021050	500	2,224	08076505	Orange/Red
08021055	550	2,446	08018505	Blue/Green
08021060	600	2,669	08015005	Orange/Black
08021065	650	2,891	08018605	Slate/Green
08021070	700	3,114	08076005	Orange/White

Part Number	Break Load		Replacement Pin	
	(LBS.)	(N)	Part Number	Color
7/8" Swivel (22 mm) continued				
08021075	750	3,336	08075505	Orange/Violet
08021080	800	3,559	08018705	Red/Yellow
08021085	850	3,781	08018805	Black/Yellow
08021090	900	4,003	08076605	Orange/Yellow
08021100	1,000	4,448	08015705	Green/White
08021110	1,100	4,893	08018905	White/Yellow
08021120	1,200	5,338	08015205	Brown/White
08021130	1,300	5,782	08019105	Brown/Yellow
08021140	1,400	6,227	08074605	Green/Red
08021150	1,500	6,672	08076905	Green/Yellow
08021160	1,600	7,117	08019205	Black/White
08021170	1,700	7,562	08019305	Red/White
08021180	1,800	8,006	08017705	Brown/Black





PULLING GRIPS

Pulling Grips

Pulling Grips offer excellent means of pulling electrical cable, bare conductors, copper telephone cable or rope through conduit. Grips are made of high-quality galvanized steel strand to assure long life. Under normal conditions, the grips should be used with a safety factor of five, but this will vary depending on the situation. The tension, diameter, movement, number of objects gripped, gripping surface and the attachments used are some of the variables affecting the safety factor. In addition, the effects of abrasion, corrosion, prior use or misuse must be considered and the grip replaced when necessary. The safety factor is ultimately determined by the user.

Fiber Optic Pulling Grips are also available. They feature a special weave that provides positive holding power while allowing the grip to remain flexible, ensuring cable protection.

Additional sizes & support grips are available, please contact Condux Customer Service for assistance.



Select The Correct Grip

Each grip is designed to work on a specific range of cable diameters.

- Step 1:** Determine your cable outside diameter.
- Step 2:** Find the grip size that encompasses your cable diameter.
- Step 3:** Whenever possible, use a closed mesh that assembles over the cable end. If the cable end is not available, use a split mesh.
- Step 4:** Where available, select an eye style that suits your needs.
- Step 5:** Estimate the tension to be put on the grip, establish the working load you require and compare this to the listed approximate breaking strength of the grip to ensure that the grip will be strong enough.

! **ORDER CAREFULLY**
These items are made-to-order and are not returnable.



Calculating grip size for multiple cables of same diameter

	Number of Cables In Bundle in (mm)							Grip Diameter Range in (mm)
	2	3	4	5	6 & 7	8	9	
Individual Cable Diameter Range	.30-.38 (8-10)	.25-.31 (6-8)	.22-.27 (6-7)	.19-.24 (5-6)	.17-.22 (4-6)	.15-.19 (4-5)	.14-.18 (3-4)	.50-.61 (13-15)
	.38-.44 (10-11)	.31-.36 (8-9)	.27-.31 (7-8)	.24-.29 (6-7)	.22-.26 (6-7)	.19-.23 (5-6)	.18-.21 (4-5)	.62-.74 (16-19)
	.44-.59 (11-15)	.36-.49 (9-12)	.31-.42 (8-11)	.29-.38 (7-10)	.26-.34 (7-9)	.23-.31 (6-8)	.21-.28 (5-7)	.75-.99 (19-25)
	.59-.75 (15-19)	.49-.63 (12-16)	.42-.54 (11-14)	.38-.48 (10-12)	.34-.43 (9-11)	.31-.39 (8-10)	.28-.35 (7-9)	1.00-1.24 (25-31)
	.75-.90 (19-23)	.63-.76 (16-19)	.54-.65 (14-17)	.48-.58 (12-15)	.43-.52 (11-13)	.39-.46 (10-12)	.35-.42 (9-11)	1.25-1.49 (31-38)
	.90-1.07 (23-27)	.76-.89 (19-23)	.65-.77 (17-19)	.58-.67 (15-17)	.52-.60 (13-15)	.46-.54 (12-14)	.42-.49 (11-12)	1.50-1.74 (38-44)
	1.07-1.22 (27-31)	.89-1.02 (23-26)	.77-.88 (19-20)	.67-.77 (17-19)	.60-.69 (15-18)	.54-.62 (14-16)	.49-.56 (12-14)	1.75-1.99 (44-51)
	1.22-1.53 (31-39)	1.02-1.28 (26-33)	.88-1.10 (20-28)	.77-.96 (19-24)	.69-.86 (18-22)	.62-.77 (16-19)	.56-.71 (14-18)	2.00-2.49 (51-63)
	1.53-1.83 (39-46)	1.28-1.53 (33-39)	1.10-1.32 (28-34)	.96-1.16 (24-29)	.86-1.03 (22-26)	.77-.93 (19-24)	.71-.85 (18-22)	2.50-2.99 (63-76)
	1.83-2.14 (46-54)	1.53-1.79 (39-45)	1.32-1.54 (34-39)	1.16-1.35 (29-34)	1.03-1.20 (26-30)	.93-1.08 (24-27)	.85-.99 (22-25)	3.00-3.49 (76-89)
	2.14-2.44 (54-62)	1.79-2.05 (45-52)	1.54-1.76 (39-45)	1.35-1.54 (34-39)	1.20-1.37 (30-35)	1.08-1.24 (27-31)	.99-1.13 (25-29)	3.50-3.99 (89-101)
	2.44-2.75 (62-70)	2.05-2.30 (52-58)	1.76-1.98 (45-50)	1.54-1.74 (39-44)	1.37-1.55 (35-39)	1.24-1.39 (31-35)	1.13-1.27 (29-32)	4.00-4.49 (101-114)
2.75-3.06 (70-78)	2.30-2.56 (58-65)	1.98-2.20 (50-56)	1.74-1.93 (44-49)	1.55-1.72 (39-44)	1.39-1.55 (35-39)	1.27-1.41 (32-36)	4.50-4.99 (114-127)	





FIBER OPTIC PULLING GRIPS

ORDER CAREFULLY
These items are made-to-order and are not returnable.

Fiber Optic Grip - Flexible Eye, Low Profile, Double/Single Weave Mesh

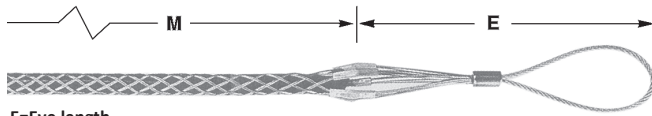

Double/Single weave mesh, galvanized steel for outside plant cable. Used for the installation of fiber optic communication lines either underground, overhead, through conduit or through enclosures. They will fit single cables or cable bundles, are easily installed on the cable and are reusable.

E=Eye length

M=Mesh length at nominal diameter.

Part Number	Description	Cable Diameter Range		Approximate Breaking Strength		E		M	
		(in)	(mm)	(lbs)	(N)	(in)	(mm)	(in)	(mm)
08643753	033-29-1193	.10-.22	3-6	900	4,003	7½	190	10	254
08643754	033-29-1194	.21-.35	5-9	1,400	6,227	7½	190	14	356
08643755	033-29-1195	.32-.48	8-12	2,000	8,896	8½	216	19	483
08643756	033-29-1196	.42-.61	11-15	2,500	11,120	8½	216	21	533
08643757	033-29-1197	.53-.74	13-19	3,000	13,344	8½	216	23	584
08643758	033-29-1198	.64-.87	16-22	4,200	18,682	8½	216	25	635
08643759	033-29-1199	.75-1.00	19-25	4,200	18,682	8½	216	28	711

Fiber Optic Grip - Flexible Eye

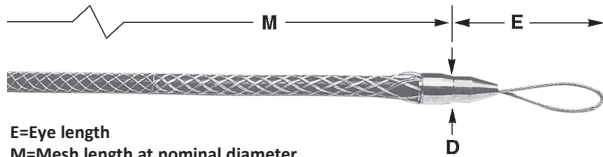

Double/Single weave mesh, galvanized steel for outside plant cable. Used for the installation of fiber optic communication lines either underground, overhead, through conduit or through enclosures. They will fit single cables or cable bundles, are easily installed on the cable and are reusable.

E=Eye length

M=Mesh length at nominal diameter.

Part Number	Description	Cable Diameter Range		Approximate Breaking Strength		E		M		D	
		(in)	(mm)	(lbs)	(N)	(in)	(mm)	(in)	(mm)	(in)	(mm)
08643505	033-29-1000	.10-.22	3-6	1,000	4,448	5½	140	9	229	.8	20
08643512	033-29-1001	.21-.35	5-9	1,500	6,672	5½	140	14	356	.8	20
08643514	033-29-1002	.32-.48	8-12	2,200	9,786	6	152	18	457	.9	23
08643518	033-29-1003	.42-.61	11-15	2,800	12,454	6	152	21	533	.9	23
08643524	033-29-1004	.53-.74	13-19	3,300	14,678	6½	165	24	610	1.3	33
08643529	033-29-1005	.64-.87	16-22	4,700	20,906	6½	165	27	686	1.3	33

Fiber Optic Grip - Swivel Eye

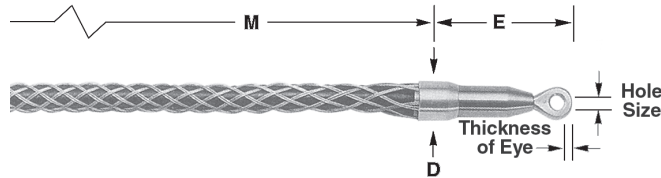

Double/Single weave mesh, galvanized steel for outside plant cable. Used for the installation of fiber optic communication lines either underground, overhead, through conduit or through enclosures. They will fit single cables or cable bundles, are easily installed on the cable and are reusable.

Part Number	Description	Cable Diameter Range		Approximate Breaking Strength		E		M		D		Hole Size		Thickness of Eye	
		(in)	(mm)	(lbs)	(N)	(in)	(mm)	(in)	(mm)	(in)	(mm)	(in)	(mm)	(in)	(mm)
08643612	033-29-1008	.21-.35	5-9	1,500	6,672	4	102	14	356	.9	23	.24	6	.5	13
08643614	033-29-1009	.32-.48	8-12	2,200	9,786	4	102	18	457	.9	23	.24	6	.5	13
08643618	033-29-1010	.42-.61	11-15	2,800	12,455	4	102	21	533	.9	23	.24	6	.5	13
08643624	033-29-1011	.53-.74	13-19	3,250	14,457	4.8	122	24	610	1.3	33	.24	6	.5	13
08643629	033-29-1012	.64-.87	16-22	4,700	20,907	4.8	122	27	686	1.3	33	.24	6	.5	13

Fiber Optic Slack Grip - Split Mesh, Rod Closing, Single Weave



Single weave mesh, galvanized steel for outside plant cable. Used for the installation of fiber optic communication lines either underground, overhead, through conduit or through enclosures. They will fit single cables or cable bundles, are easily installed on the cable and are reusable.

E=Eye length

M=Mesh length at nominal diameter.

Part Number	Description	Cable Diameter Range		Approximate Breaking Strength		E		M	
		(in)	(mm)	(lbs)	(N)	(in)	(mm)	(in)	(mm)
08643713	033-29-1015	.25-.37	6-9	300	1,334	3	76	4.7	119
08643716	033-29-1016	.38-.49	10-12	800	3,559	3	76	5	127
08643722	033-29-1017	.50-.61	13-15	800	3,559	3	76	7½	191
08643728	033-29-1018	.62-.74	16-19	1,200	5,338	3	76	8	203



CONDEX

PULLING GRIPS



Junior Grip

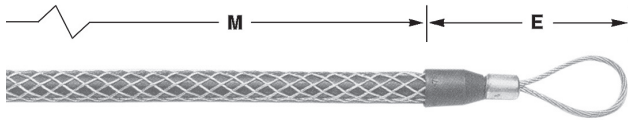

E=Eye length
M=Mesh length at nominal diameter.

Junior Pulling Grips feature a strong galvanized steel, single weave mesh. A flexible eye easily attaches to a pulling line, snake or fish tape. Designed to pull building wire, Junior grips are safe tools to use in pulling wire at low tension through conduit during electrical construction.

Part Number	Description	Cable Diameter Range		Approximate Breaking Strength		E		M	
		(in)	(mm)	(lbs)	(N)	(in)	(mm)	(in)	(mm)
08643210	033-05-011	.19-.24	5-6	400	1,779	3 3/4	83	4 1/4	108
08643213*	033-05-001	.25-.37	6-9	450	2,002	3 3/4	83	4 1/4	108
08643216*	033-05-002	.38-.49	10-12	900	4,003	3 3/4	95	7	178
08643222*	033-05-003	.50-.62	13-16	1,300	5,783	4 1/4	108	8 1/2	216
08643228*	033-05-004	.63-.74	16-19	1,950	8,674	5	127	10	254
08643231*	033-05-005	.75-.99	19-25	2,800	12,455	5 3/4	146	10	254
08643237*	033-05-006	1.00-1.24	25-31	3,900	17,348	6 1/2	165	11 1/2	292

Junior Grip Kit

Contains items indicated with (*) in Junior Grip chart above.

Part Number 08643200



Light Duty Grip - Short

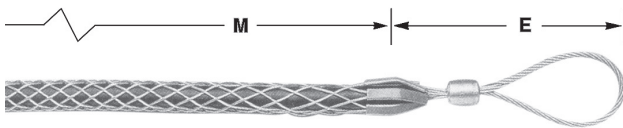

E=Eye length
M=Mesh length at nominal diameter.

Light Duty Pulling Grips are made of galvanized steel in a single weave construction. They feature a flexible eye for easy attachment to a pulling line. Light duty grips are used in general underground electrical construction where pulling tensions are low. They are easy tools to use in wiring industrial plants and commercial buildings.

Part Number	Description	Cable Diameter Range		Approximate Breaking Strength		E		M	
		(in)	(mm)	(lbs)	(N)	(in)	(mm)	(in)	(mm)
08643022	033-03-001	.50-.62	13-16	2,800	12,455	5	127	11	279
08643028	033-03-002	.63-.74	16-19	2,800	12,455	5	127	11	279
08643031	033-03-003	.75-.99	19-25	4,000	17,792	6	152	12	305
08643037	033-03-004	1.00-1.24	25-31	5,300	23,576	7	178	13	330
08643043	033-03-005	1.25-1.49	32-38	5,300	23,576	7	178	14	356
08643049	033-03-006	1.50-1.74	38-44	6,800	30,248	8	203	15	381
08643052	033-03-007	1.75-1.99	44-51	8,500	37,810	9	229	17	432
08643055	033-03-008	2.00-2.49	51-63	8,500	37,810	9	229	18	457

Light Duty Grip - Standard

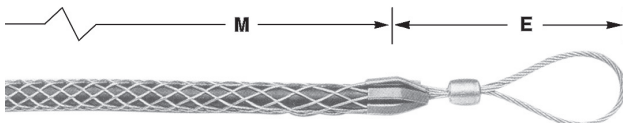

Light Duty Pulling Grips are made of galvanized steel in a single weave construction. They feature a flexible eye for easy attachment to a pulling line. Light duty grips are used in general underground electrical construction where pulling tensions are low. They are easy tools to use in wiring industrial plants and commercial buildings.

Part Number	Description	Range		Approximate Breaking Strength		E		M	
		(in)	(mm)	(lbs)	(N)	(in)	(mm)	(in)	(mm)
08643122	033-03-010	.50-.62	13-16	2,800	12,455	5	127	16	406
08643128	033-03-011	.63-.74	16-19	2,800	12,455	5	127	16	406
08643131	033-03-012	.75-.99	19-25	4,000	17,792	6	152	20	508
08643137	033-03-013	1.00-1.24	25-31	6,800	30,248	7	178	20	508
08643143	033-03-015	1.25-1.49	32-38	6,800	30,248	7	178	21	533
08643149	033-03-016	1.50-1.99	38-51	6,800	30,248	8	203	23	584
08643155	033-03-017	2.00-2.49	51-63	8,500	37,810	9	229	25	635
08643158	033-03-018	2.50-2.99	64-76	10,600	47,151	9	229	27	686
08643161	033-03-019	3.00-3.49	76-89	14,700	65,389	10	254	30	762
08643164	033-03-029	3.50-3.99	89-101	14,700	65,389	10	254	32	813

PULLING EYES & ACCESSORIES





PULLING GRIPS

ORDER CAREFULLY
These items are made-to-order and are not returnable.

T-Type Grips - Short, Flexible Eye

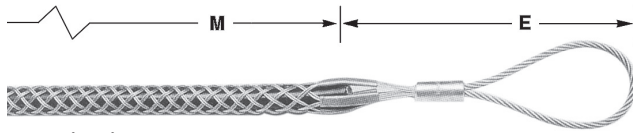

E=Eye length
M=Mesh length at nominal diameter.

Flexible T-Type Pulling Grips are made of high strength galvanized steel strand. They feature double weave mesh for positive holding power in medium to heavy pulling jobs. The grip eye will easily attach to a swivel. They are used for the installation of underground power cables, communication lines and service lines into factories, construction projects and for general underground electrical construction. Available in two mesh lengths, short for medium pulls, and standard for general purpose pulling.

Part Number	Description	Cable Diameter Range		Approximate Breaking Strength		E		M	
		(in)	(mm)	(lbs)	(N)	(in)	(mm)	(in)	(mm)
08642222	033-04-1082	.50-.62	13-16	4,500	20,017	8	203	21	533
08642228	033-04-1083	.63-.74	16-19	5,600	24,910	8	203	24	610
08642231	033-04-1084	.75-.99	19-25	6,800	30,248	9	229	24	610
08642237	033-04-1085	1.00-1.49	25-38	9,600	42,703	9	229	24	610
08642249	033-04-1086	1.50-1.99	38-51	16,400	72,951	11	279	24	610
08642255	033-04-1087	2.00-2.49	51-63	18,500	82,292	12	305	24	610
08642258	033-04-1088	2.50-2.99	64-76	24,500	108,981	12	305	24	610
08642261	033-04-1089	3.00-3.49	76-89	24,500	108,981	14	356	24	610
08642264	033-04-1090	3.50-3.99	89-101	31,000	137,895	14	356	26	660

T-Type Grips - Standard, Flexible Eye

Part Number	Description	Cable Diameter Range		Approximate Breaking Strength		E		M	
		(in)	(mm)	(lbs)	(N)	(in)	(mm)	(in)	(mm)
08642331	033-04-1091	.75-.99	19-25	6,800	30,248	9	229	36	914
08642337	033-04-1092	1.00-1.49	25-38	9,600	42,703	9	229	36	914
08642349	033-04-1093	1.50-1.99	38-51	16,400	72,951	11	279	36	914
08642355	033-04-1094	2.00-2.49	51-63	18,500	82,292	12	305	36	914
08642358	033-04-1095	2.50-2.99	64-76	24,500	108,981	12	305	36	914
08642361	033-04-1096	3.00-3.49	76-89	24,500	108,981	14	356	36	914
08642364	033-04-1097	3.50-3.99	89-101	31,000	137,895	14	356	40	1,016

K-Type Grips* - Short, Forged Eye

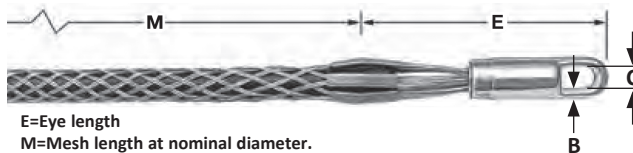

E=Eye length
M=Mesh length at nominal diameter.

Rotating Eye, K-Type Pulling Grips are made of high strength galvanized steel strand. All grips feature double weave mesh for greater strength and added mesh contact on the cable, to handle longer or heavier pulling jobs. The forged eye mates easily with a swivel or shackle. They are specially designed for use in the installation of underground power cables, communication lines and service lines into factories, shopping centers, construction projects and general underground electrical construction.

Part Number	Description	Cable Diameter Range		Approximate Breaking Strength		E		M		B		C	
		(in)	(mm)	(lbs)	(N)	(in)	(mm)	(in)	(mm)	(in)	(mm)	(in)	(mm)
08642022	033-01-001	.50-.62	13-16	5,600	24,910	5	127	11	279	9/32	7	1/2	13
08642028	033-01-002	.63-.74	16-19	6,800	30,248	5	127	11	279	9/32	7	1/2	13
08642031	033-01-013	.75-.99	19-25	6,800	30,248	6	152	20	508	1/2	13	9/16	14
08642037	033-01-014	1.00-1.24	25-31	12,800	56,937	7	178	20	508	1/2	13	11/16	17
08642043	033-01-016	1.25-1.49	32-38	12,800	56,937	7	178	21	533	1/2	13	11/16	17
08642049	033-01-017	1.50-1.99	38-51	16,400	72,951	7	178	25	635	1/2	13	11/16	17
08642055	033-01-018	2.00-2.49	51-63	27,200	120,992	8	203	26	660	5/8	16	7/8	22
08642058	033-01-019	2.50-2.99	64-76	33,000	146,791	10	254	28	711	21/32	17	1	25
08642061	033-01-020	3.00-3.49	76-89	41,000	182,377	10	254	30	762	21/32	17	1	25
08642064	033-01-021	3.50-3.99	89-101	48,000	213,515	10	254	32	813	21/32	17	1	25
08642067	033-01-1017	4.00-4.49	102-114	48,000	213,515	10	254	33	838	21/32	17	1	25

K-Type Grips* - Standard, Forged Eye

Part Number	Description	Cable Diameter Range		Approximate Breaking Strength		E		M		B		C	
		(in)	(mm)	(lbs)	(N)	(in)	(mm)	(in)	(mm)	(in)	(mm)	(in)	(mm)
08642122	033-01-011	.50-.62	13-16	5,600	24,910	5	127	16	406	9/32	7	1/2	13
08642128	033-01-012	.63-.74	16-19	6,800	30,248	5	127	16	406	9/32	7	1/2	13
08642131	033-01-024	.75-.99	19-25	9,600	42,703	6	152	32	813	1/2	13	9/16	14
08642137	033-01-025	1.00-1.49	25-38	16,400	72,951	7	178	33	838	1/2	13	11/16	17
08642149	033-01-026	1.50-1.99	38-51	16,400	72,951	7	178	34	864	1/2	13	11/16	17
08642155	033-01-027	2.00-2.49	51-63	27,200	120,992	9	229	36	914	5/8	16	7/8	22
08642158	033-01-028	2.50-2.99	64-76	33,000	146,791	10	254	38	965	21/32	17	1	25
08642161	033-01-029	3.00-3.49	76-89	41,000	182,377	10	254	39	991	21/32	17	1	25
08642164	033-01-030	3.50-3.99	89-101	48,000	213,515	10	254	41	1,041	21/32	17	1	25
08642167	033-01-031	4.00-4.49	102-114	48,000	213,515	10	254	42	1,067	21/32	17	1	25
08642170	033-01-039	4.50-4.99	114-127	48,000	213,515	10	254	58	1,473	21/32	17	1	25
08642173	033-01-047	5.00-5.99	127-152	48,000	213,515	10	254	60	1,524	21/32	17	1	25
08642176	033-01-045	6.00-6.99	152-178	48,000	213,515	10	254	66	1,676	21/32	17	1	25



PULLING GRIPS



Multiple Strength Grip - Rotating Eye*

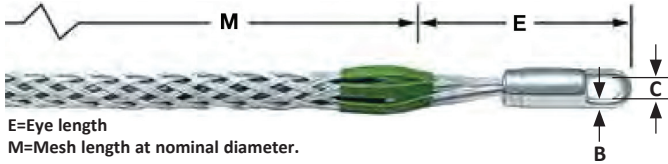

E=Eye length
M=Mesh length at nominal diameter.

Multiple Strength Pulling Grips are designed for pulling ACSR, aluminum or copper bare conductor, ground wires, messenger strands, wire rope and insulated cables. They are ideal for overhead transmission and distribution line stringing where moderate loading is anticipated. They are economical tools used for attaching conductors to pulling lines and double socking for conductor-to-conductor connections.

Part Number	Description	Color	Cable Diameter Range		Approximate Breaking Strength		E		M		B		C	
			(in)	(mm)	(lbs)	(N)	(in)	(mm)	(in)	(mm)	(in)	(mm)	(in)	(mm)
08641813	033-02-016	Dark Green	.25-.49	6-12	6,800	30,248	5	127	26	660	⁹ / ₃₂	7	¹ / ₂	13
08641822	033-02-018	Brown	.50-.74	13-19	10,000	44,482	6	152	32	813	¹ / ₂	13	⁹ / ₁₆	14
08641831	033-02-020	Light Blue	.75-.99	19-25	14,400	64,054	6	152	41	1,041	¹ / ₂	13	⁹ / ₁₆	14
08641837	033-02-022	Gold	1.00-1.24	25-31	24,600	109,426	8	203	52	1,321	¹ / ₂	13	¹¹ / ₁₆	17
08641843	033-02-024	Black	1.25-1.49	32-38	30,600	136,116	8	203	56	1,422	⁵ / ₈	16	⁷ / ₈	22
08641849	033-02-026	Red	1.50-1.74	38-44	30,600	136,116	9	229	60	1,524	²¹ / ₃₂	17	1	25
08641852	033-02-028	Dark Blue	1.75-2.24	44-57	48,000	213,515	10	254	70	1,778	²¹ / ₃₂	17	1	25
08641855	033-02-066	Yellow	2.00-2.49	51-63	48,000	213,515	10	254	50	1,270	²¹ / ₃₂	17	1	25
08641858	033-02-097	Orange	2.50-2.99	64-76	48,000	213,515	10	254	52	1,321	²¹ / ₃₂	17	1	25
08641861	033-02-1030	Aluminum	3.00-3.49	76-89	48,000	213,515	10	254	50	1,270	²¹ / ₃₂	17	1	25
08641864	033-02-1031	Light Green	3.50-3.99	89-101	48,000	213,515	10	254	53	1,346	²¹ / ₃₂	17	1	25

*Rotating Eye is not a swivel. It will not turn while under tension, but it can turn to relieve pulling torque when the tension is relaxed.

Multiple Strength Grip - Flexible Eye

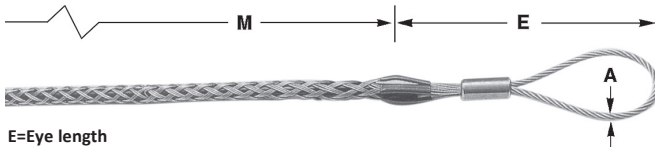

E=Eye length
M=Mesh length at nominal diameter.

Multiple Strength Pulling Grips are designed for pulling ACSR, aluminum or copper bare conductor, ground wires, messenger strands, wire rope and insulated cables. They are ideal for overhead transmission and distribution line stringing where moderate loading is anticipated. They are economical tools used for attaching conductors to pulling lines and double socking for conductor-to-conductor connections.

Part Number	Description	Color	Cable Diameter Range		Approximate Breaking Strength		E		M		Cable Dia. A	
			(in)	(mm)	(lbs)	(N)	(in)	(mm)	(in)	(mm)	(in)	(mm)
08641913	033-02-044	Dark Green	.25-.49	6-12	6,800	30,248	9	229	26	660	¹ / ₄	6
08641922	033-02-046	Brown	.50-.74	13-19	10,000	44,482	9	229	32	813	⁵ / ₁₆	8
08641931	033-02-048	Light Blue	.75-.99	19-25	14,400	64,054	11	279	41	1,041	³ / ₈	10
08641937	033-02-050	Gold	1.00-1.24	25-31	24,600	109,426	12	305	52	1,321	¹ / ₂	13
08641943	033-02-052	Black	1.25-1.49	32-38	30,600	136,116	12	305	56	1,422	¹ / ₂	13
08641949	033-02-054	Red	1.50-1.74	38-44	30,600	136,116	12	305	60	1,524	¹ / ₂	13
08641952	033-02-056	Dark Blue	1.75-2.24	44-57	48,000	213,515	18	457	70	1,778	⁵ / ₈	16
08641955	033-02-1078	Yellow	2.00-2.49	51-63	48,000	213,515	18	457	50	1,270	⁵ / ₈	16
08641958	033-02-1079	Orange	2.50-2.99	64-76	48,000	213,515	18	457	52	1,321	⁵ / ₈	16
08641961	033-02-1080	Aluminum	3.00-3.49	76-89	48,000	213,515	18	457	50	1,270	⁵ / ₈	16
08641964	033-02-1081	Light Green	3.50-3.99	89-101	48,000	213,515	18	457	53	1,346	⁵ / ₈	16





PULLING GRIPS

ORDER CAREFULLY
These items are made-to-order and are not returnable.

Dua-Pull® Grips**

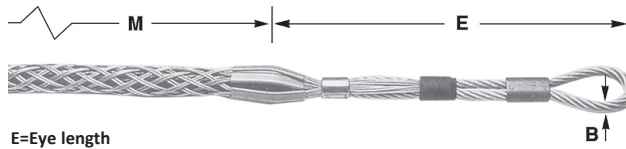

E=Eye length
M=Mesh length at nominal diameter.

Dua-Pull Pulling Grips are the highest strength pulling grips manufactured for overhead transmission line stringing applications. They are most commonly used for attaching pulling lines to conductors, conductors to running boards and double socking for conductor-to-conductor connections. They accommodate ACSR, ACAR, all aluminum and copper conductors, ground wires messenger strands and synthetic ropes not provided by any other grip.

Part Number	Description	Color	Conductor Dia. Range		Rope Dia. Range*		Approx. Breaking Strength		E		M		B	
			(in)	(mm)	(in)	(mm)	(lbs)	(N)	(in)	(mm)	(in)	(mm)	(in)	(mm)
08641710	033-27-1037	Black	.19-.37	5-9	.25-.65	6-17	6,500	28,913	10	254	24	610	.220	6
08641716	033-27-1038	Dark Green	.38-.62	10-16	.50-.90	13-23	14,000	62,275	12	305	36	914	.375	10
08641728	033-27-1039	Red	.63-.87	16-22	.75-1.10	19-28	20,000	88,964	13	330	48	1,219	.437	11
08641734	033-27-1040	Dark Blue	.88-1.12	22-28	1.00-1.50	25-38	30,600	136,116	15	381	60	1,524	.500	13
08641740	033-27-1041	Yellow	1.13-1.37	29-35	1.25-1.70	32-43	46,800	208,177	18	457	76	1,930	.625	16
08641746	033-27-1042	Aluminum	1.38-1.90	35-48	1.50-2.10	38-53	66,500	295,807	24	610	89	2,261	.750	19

*For rope, select smallest size grip which meets required work load.
** Dua-Pull is a registered trademark of Kellems.

Dua-Pull Feed Tube

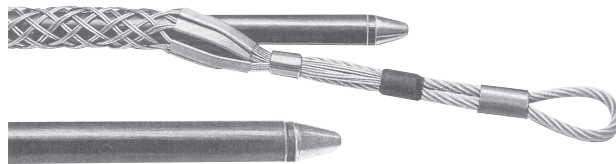

The Feed Tube is used when assembling synthetic rope into the Dua-Pull Grip. It is required on the two largest sizes of Dua-Pull Grips. Feed Tubes are available for use on all sizes of Dua-Pull Grips.

Part Number	Description	For Use With Dua-Pull Grip	Rope Diameter		Feed Tube Length	
			(in)	(mm)	(in)	(mm)
08641610	091-06-1043	08641710	.25-.65	6-17	28	711
08641616	091-06-1044	08641716	.50-.90	13-23	40	1,016
08641628	091-06-1045	08641728	.75-1.10	19-28	52	1,321
08641634	091-06-1046	08641734	1.00-1.50	25-38	67	1,702
08641640	091-06-1047	08641740	1.25-1.70	32-43	83	2,108
08641646	091-06-1048	08641746	1.50-2.10	38-53	96	2,438

Non-Conductive Grip

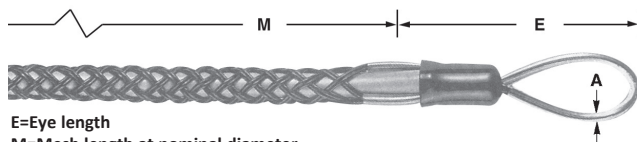

E=Eye length
M=Mesh length at nominal diameter.

Non-Conductive Pulling Grips are made of a high strength, non-conductive aramid fiber, and are available for pulling single cable or cable bundles. Their braided double weave design adds strength and positive holding power. They were developed for use by utilities for pulling overhead distribution lines in close proximity to energized lines and hardware.

Part Number	Description	Color	Cable Diameter Range		Approximate Breaking Strength		E		M		Cable Dia. A	
			(in)	(mm)	(lbs)	(N)	(in)	(mm)	(in)	(mm)	(in)	(mm)
08642422	036-28-001	Green	.50-.62	13-16	1,000	4,448	5.5	140	24.0	610	.44	11
08642428	036-28-002	Yellow	.63-.74	16-19	2,000	8,896	5.5	140	26.0	660	.44	11
08642431	036-28-003	Red	.75-.99	19-25	2,000	8,896	6.0	152	31.0	787	.63	16
08642437	036-28-004	Blue	1.00-1.24	25-31	3,000	13,345	6.5	165	36.0	914	.63	16
08642443	036-28-005	White	1.25-1.49	32-38	3,000	13,345	6.7	170	41.5	1,054	.63	16



CONDEX

PULLING GRIPS



PULLING EYES & ACCESSORIES

Slack Grip - Closed Mesh

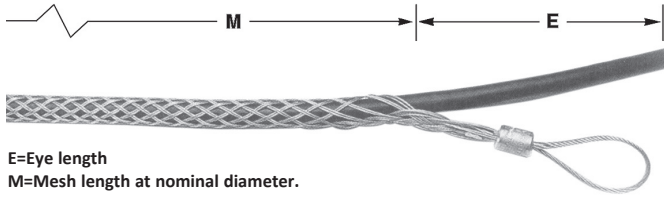

E=Eye length
M=Mesh length at nominal diameter.

Slack Grip - Closed Mesh Pulling Grips are made of high strength galvanized steel in a double weave construction with a single eye. The closed mesh style grip is used when the cable end is accessible. All grips feature a single offset eye for easy attachment to a pulling line. They are used to pull in slack for final placement of underground cable after it has been pulled in. They are also used for removing cable.

Part Number	Description	Cable Diameter Range		Approximate Breaking Strength		E		M	
		(in)	(mm)	(lbs)	(N)	(in)	(mm)	(in)	(mm)
08642531	033-08-003	.75-.99	19-25	2,600	11,565	7	178	12	305
08642537	033-08-004	1.00-1.24	25-31	4,000	17,793	8	203	15	381
08642543	033-08-005	1.25-1.49	32-38	5,400	24,020	8	203	16	406
08642549	033-08-006	1.50-1.74	38-44	6,600	29,358	8	203	20	508
08642552	033-08-007	1.75-1.99	44-51	10,000	44,482	10	254	18	457
08642555	033-08-008	2.00-2.49	51-63	11,000	48,930	10	254	19	483
08642558	033-08-009	2.50-2.99	64-76	11,000	48,930	10	254	20	508
08642561	033-08-010	3.00-3.49	76-89	14,500	64,499	12	305	21	533
08642564	033-08-011	3.50-3.99	89-101	14,500	64,499	12	305	22	559

Slack Grip - Split Mesh, Lace Closing



E=Eye length
M=Mesh length at nominal diameter.

Slack Grip - Split Mesh, Lace Closing Pulling Grips are made of high strength galvanized steel in a double weave construction with a single eye. The split lace closing style grip is used when the cable end is not accessible. All grips feature a single offset eye for easy attachment to a pulling line. They are used to pull in slack for final placement of underground cable after it has been pulled in. They are also used for removing cable. Standard mesh lengths are generally used in restricted space for short pulls. Longer lengths are used for higher pulling loads where space is not restricted.

Part Number	Description	Cable Diameter Range		Approximate Breaking Strength		E		M	
		(in)	(mm)	(lbs)	(N)	(in)	(mm)	(in)	(mm)
08642731	033-09-003	.75-.99	19-25	2,500	11,121	7	178	12	305
08642737	033-09-004	1.00-1.24	25-31	3,500	15,569	8	203	15	381
08642743	033-09-005	1.25-1.49	32-38	4,000	17,793	8	203	16	406
08642749	033-09-006	1.50-1.74	38-44	4,000	17,793	9	229	17	432
08642752	033-09-007	1.75-1.99	44-51	4,000	17,793	10	254	18	457
08642755	033-09-008	2.00-2.49	51-63	4,000	17,793	10	254	19	483
08642758	033-09-009	2.50-2.99	64-76	4,000	17,793	10	254	20	508
08642849	033-09-015	1.50-1.99	38-51	4,000	17,793	9	229	25	635
08642855	033-09-016	2.00-2.49	51-63	4,000	17,793	10	254	26	660
08642858	033-09-017	2.50-2.99	64-76	4,000	17,793	10	254	29	737
08642861	033-09-018	3.00-3.49	76-89	4,000	17,793	12	305	32	813
08642864	033-09-019	3.50-3.99	89-101	4,000	17,793	12	305	35	889

Slack Grip - Split Mesh, Rod Closing

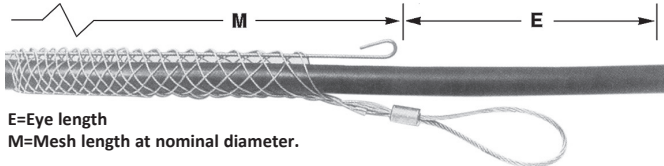

E=Eye length
M=Mesh length at nominal diameter.

Slack Grip - Split Mesh, Rod Closing Pulling Grips are made of high strength galvanized steel in a single weave construction with a single eye. The split rod closing style grip is used when the cable end is not accessible. All grips feature a single offset eye for easy attachment to a pulling line. They are used to pull in slack for final placement of underground cable after it has been pulled in. They are also used for removing cable.

Part Number	Description	Cable Diameter Range		Approximate Breaking Strength		E		M	
		(in)	(mm)	(lbs)	(N)	(in)	(mm)	(in)	(mm)
08642922	033-10-001	.50-.61	13-15	1,500	6,672	7	178	6	152
08642928	033-10-002	.62-.74	16-19	1,800	8,007	7	178	8	203
08642931	033-10-003	.75-.99	19-25	2,200	9,786	7	178	10	254
08642937	033-10-004	1.00-1.24	25-31	3,400	15,124	8	203	12	305
08642943	033-10-005	1.25-1.49	32-38	4,500	20,017	8	203	14	356
08642949	033-10-006	1.50-1.74	38-44	5,800	25,800	9	229	15	381
08642952	033-10-007	1.75-1.99	44-51	7,600	33,806	10	254	16	406
08642955	033-10-008	2.00-2.49	51-63	9,000	40,034	10	254	19	483
08642958	033-10-009	2.50-2.99	64-76	11,000	48,930	10	254	20	508
08642961	033-10-010	3.00-3.49	76-89	12,000	53,379	12	305	21	533
08642964	033-10-011	3.50-3.99	89-101	12,000	53,379	12	305	24	610





PE & PVC PULLING EYES

PE & PVC Pulling Eyes

The Condux PE & PVC Pulling Eyes feature three designs to suit your needs.

The non-sleeved design provides optimum gripping power, an extremely rigid center rod to prevent bending, and a steel tapered lead cone with the same O.D. as the conduit. The sleeved versions are water tight eyes that feature a multiple O-Ring configuration. These also have an extremely rigid center rod and sleeves designed to protect the outer leading edge of the conduit to form a water tight seal. Both the sleeved and non-sleeved designs feature split gripping segments with aggressive gripping threads, coupled with a steel expansion plug that grips the full range of conduit I.Ds.

Installation of the PE & PVC Pulling Eyes simply requires the leading eye to be tightened. The pulling eyes come standard with attachment eyes at both ends for connecting rope or steel lines. Pull-out strengths generally exceed the tensile capacity of the conduit.

NOTE: PE & PVC Pulling Eyes come with a 90 day limited warranty.

See chart on page 56 for swivel compatibility. Replacement O-Rings on page 57.



Non Sleeved Pulling Eye
(page 54)



Short Sleeved Pulling Eye
(page 55)



Long Sleeved Pulling Eye
(page 55)

PE & PVC Pulling Eyes Non-Sleeved Part Numbers

Part Number	Nominal Size (IN.)	Length		Conduit ID				Lead Cone OD		Duct Type	Nominal Duct ID	
		(IN.)	(MM)	Minimum (IN.)	Maximum (MM)	(IN.)	(MM)	(IN.)	(MM)		(IN.)	(MM)
08220220	1.5	8.33	211	1.51	38	1.80	46	2.375	60	1.5 SDR 11.0-17.0	1.53-1.66	39-42
										1.5 SCH 40	1.59	40
										1.5 SIDR	1.61	41
08220020	2	8.18	206	1.88	48	2.15	55	2.375	60	2.0 SDR 11.0-17.0	1.92-2.08	49-53
										2.0 SCH 80	1.91	49
										2.0 SCH 40	2.05	52
										2.0 SIDR	2.07	53
08220030	3	11.89	302	2.69	68	3.13	79	4.00	102	3.0 SDR 11.0-17.0	2.83-3.06	72-78
										3.0 SCH 80	2.83	72
										3.0 SCH 40	3.04	77
										3.0 SIDR	3.07	78
08220611	4	14.11	358	3.50	89	4.20	106	4.81	122	4.0 SDR 11.0-17.0	3.63-3.94	92-100
										4.0 SCH 80	3.79	96
										4.0 SCH 40	4.00	102
										4.0 SIDR	4.03	102
08220050	5	18.45	469	4.25	108	5.06	129	5.56	141	5.0 SDR 11.0-21.0	4.49-5.03	114-128
										5.0 SCH 80	4.77	121
										5.0 SCH 40	5.02	128
08220060	6	19.6	498	5.06	129	6.00	152	7.00	178	6.0 SDR 11.0-21.0	5.35-5.96	136-151
										6.0 SCH 80	5.71	145



PE & PVC PULLING EYES



PE & PVC Pulling Eyes: Short Sleeved and Long Sleeved Part Numbers

Short Sleeved Part Number	Long Sleeved Part Number	Nominal Size (IN.)	Length (IN.) (MM)		Conduit ID				Sleeve ID (IN.) (MM)		Duct Type	Nominal Duct ID	
					Minimum (IN.) (MM)		Maximum (IN.) (MM)					(IN.)	(MM)
08220612	08220620	1.0	6.23	158	1.00	25	1.25	32	1.415	36	1.0 SDR 11.0	1.06	27
											1.0 SDR 13.5	1.10	28
											1.25 SDR 11.0	1.33	34
											1.25 SCH 40	1.34	34
											1.25 SDR 13.5	1.39	35
08220600	08220621	1.25	6.23	158	1.25	32	1.50	38	1.76	48	1.25 SDR 15.5	1.43	36
											1.25 SDR 17.0	1.44	37
											1.25 SDR 21.0	1.50	38
											1.50 SDR 11.0	1.53	39
											1.50 SDR 13.5	1.60	41
08220601	08220622	1.5	6.23	158	1.50	38	1.75	44	2.01	51	1.50 SCH 40	1.59	40
											1.50 SDR 15.5	1.63	41
											1.50 SDR 17.0	1.66	42
											1.50 SDR 21.0	1.72	44
											2.0 SDR 11.0	1.92	49
08220602	08220623	2.0	8.18	208	1.88	48	2.15	55	2.45	62	2.0 SDR 13.5	2.00	51
											2.0 SDR 15.5	2.05	52
											2.0 SCH 40	2.05	52
											2.0 SDR 17.0	2.08	53
											2.0 SDR 21.0	2.15	55
08220609	08220624	2.5	8.80	224	2.31	59	2.56	65	3.01	76	2.5 SDR 11.0	2.32	59
											2.5 SDR 13.5	2.42	61
											2.5 SCH 40	2.45	62
											2.5 SDR 15.5	2.48	63
											2.5 SDR 17.0	2.52	64
08220603	08220625	3	11.89	302	2.69	68	3.13	79	3.63	92	3.0 SDR 11.0	2.83	72
											3.0 SDR 13.5	2.95	75
											3.0 SDR 15.5	3.02	77
											3.0 SDR 17.0	3.06	78
											3.0 SCH 40	3.04	77
08220604	08220626	4	14.11	358	3.50	89	4.06	103	4.63	118	4.0 SDR 11.0	3.63	92
											4.0 SDR 13.5	3.79	96
											4.0 SCH 80	3.79	96
											4.0 SDR 15.5	3.89	99
											4.0 SDR 17.0	3.94	100
08220605	08220627	5	18.45	469	4.25	108	5.06	129	5.63	143	4.0 SDR 21.0	4.05	103
											5.0 SDR 11.0	4.49	114
											5.0 SDR 13.5	4.69	119
											5.0 SDR 15.5	4.80	122
											5.0 SDR 17.0	4.87	124
08220606	08220628	6	19.60	498	5.06	129	6.00	152	6.76	172	5.0 SDR 21.0	5.00	127
											5.0 SCH 40	5.05	128
											6.0 SDR 11.0	5.35	136
											6.0 SDR 13.5	5.58	142
											6.0 SDR 15.5	5.72	145
08220608	08220629	8	21.53	547	6.63	168	7.69	195	8.84	224	6.0 SDR 17.0	5.80	147
											6.0 SDR 21.0	5.96	151
											8.0 SDR 11.0	6.96	177
											8.0 SDR 13.5	7.27	185
											8.0 SDR 15.5	7.45	189
08220613	08220630	8	21.53	547	7.63	194	8.25	209	8.84	224	Bore-Gard	7.981	203
											Heavy Wall SCH 40	7.981	203

PULLING EYES & ACCESSORIES





PE & PVC PULLING EYES



D. Drill Swivels & PE & PVC Pulling Eye Compatibility Chart

Swivel Part Number	Swivel Size		Compatible PE/PVC Eye Size (in)
	(in)	(mm)	
08190016	1-5/8	41	1.0 - 3.0
08190020	2	51	1.0 - 3.0
08190025	2-1/2	64	2.0 - 6.0
08190030	3	76	4.0 - 6.0
08190408	7/8	22	1.0 - 1.5
08190412	1-1/4	32	1.0 - 3.0
08190416	1-5/8	41	1.0 - 3.0
08190421	2	51	1.0 - 3.0
08190426	2-1/2	64	2.0 - 8.0
08190431	3	76	4.0 - 8.0





CONDEX

PE & PVC PULLING EYES



Replacement O-Ring Part Numbers

PE & PVC Pulling Eyes Non-Sleeved O-Rings

Pulling Eye Part Number	Expansion O-Ring Part Number	Quantity Per Eye
08220220	08010414	2
08220030	02269624	3
08220611	02269621	3
08220050	02269626	6
08220060	02269622	6

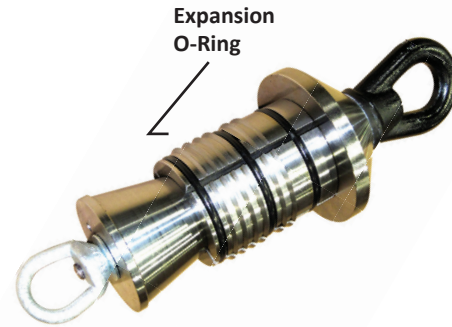

PE & PVC Pulling Eyes Short and Long Sleeved O-Rings

Pulling Eye Part Number	Expansion O-Ring Part Number	Quantity Per Eye	O-Rings in Sleeve Part Number	Quantity Per Eye
08220612 08220620	02288918	2	02289886	2
08220600 08220621	02269636	2	02288994	2
08220601 08220622	08010414	2	02288920	2
08220602 08220623	02269625	2	02288921	2
08220609 08220624	02269633	3	02288993	2
08220603 08220625	02269624	3	02288922	2
08220604 08220626	02269621	3	02288888	2
08220605 08220627	02269626	6	02288927	2
08220606 08220628	02269622	6	02288890	2
08220608 08220629	02269631	6	02288923	2
08220613 08220630	02269631	6	02288923	2

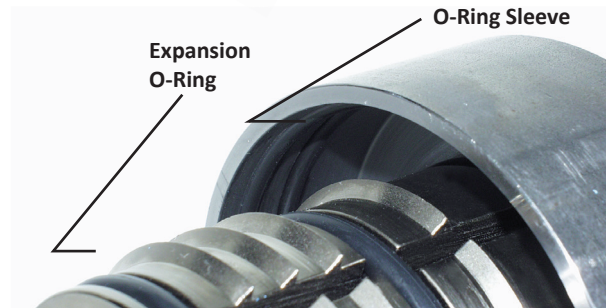

PULLING EYES & ACCESSORIES





INNERDUCT PULLING PRODUCTS



Swivel Head Innerduct Pulling Eye

The Innerduct Pulling Eye is a hybrid tool that combines features from standard innerduct pulling eyes and Condux swivels. A swivel head prevents twisting and binding of the innerduct as it is installed. It eliminates the need for a separate swivel on each pulling eye when installing single innerducts into individual conduits or multiple innerducts into a single conduit. Its short length is an advantage on tight bends compared to using a separate swivel and pulling eye. Easily installed using a 1³/₈" deep socket or adjustable wrench.

NOTE: To determine correct pulling eye size, obtain the actual innerduct inside diameter (I.D.). The I.D. measurement must be greater than dimension A and smaller than dimension B.

Replacement Clevis Pins for Swivel Head Innerduct Pulling Eyes

Part Number	Replacement Part Number
08960712	08081036
08960715	08081036
08960720	08081036

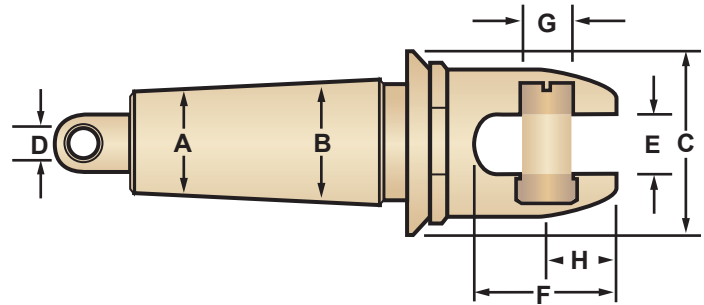

! See compatibility chart on page 61 to determine what Innerduct Pulling Eyes work with various standard innerduct sizes.

Part Number	Nominal Size	Innerduct ID Range		Max OD C		Hole Diameter D		Slot Width E		Slot Depth F		Pin Diameter G		Pin Center H	
	(IN.)	A - B (IN.)	A - B (MM)	(IN.)	MM	(IN.)	MM	(IN.)	(MM)	(IN.)	(MM)	(IN.)	(MM)	(IN.)	(MM)
08960712	1 - 1.25	1.06 - 1.43	27 - 37	1.75	44	.44	11	.56	14	1.31	33	.43	11	.56	14
08960715	1.50	1.37 - 1.68	35 - 43	2.00	51	.44	11	.56	14	1.31	33	.43	11	.56	14
08960720	2.00	1.93 - 2.12	49 - 54	2.44	62	.44	11	.56	14	1.31	33	.43	11	.56	14

All Swivel Head Innerduct Pulling Eyes are compatible with all Condux pulling harness legs.



CONDEX

INNERDUCT PULLING PRODUCTS



Clevis Head Innerduct Pulling Eye

With the same tapered threads as the fixed head innerduct pulling eyes, these pulling eyes feature a slotted head with clevis pin to permit direct attachment to any Condux multiple pulling harness leg ends. When properly sized and installed, these eyes will not pull out of the innerduct until the pulling tensions have greatly exceeded the maximum pulling tensions recommended by the innerduct manufacturers.

NOTE: To determine correct pulling eye size, obtain the actual innerduct inside diameter (I.D.). The I.D. measurement must be greater than dimension A and smaller than dimension B.

Replacement Clevis Pins for Clevis Head Innerduct Pulling Eyes

Part Number	Replacement Part Number
08914310	08081046
08914320	08081036
08914330	08210135
08914340	08081016
08914350	08081016
08914360	08081006



See compatibility chart on page 61 to determine what Innerduct Pulling Eyes work with various standard innerduct sizes.



PULLING EYES & ACCESSORIES

Part Number	Nominal Size	Innerduct ID Range		Max OD C		Hole Diameter D		Slot Width E		Slot Depth F		Pin Diameter G		Pin Center H	
	(IN.)	A - B (IN.)	A - B (MM)	(IN.)	MM	(IN.)	MM	(IN.)	(MM)	(IN.)	(MM)	(IN.)	(MM)	(IN.)	(MM)
08914310	0.75	.73 - .94	19 - 24	1.25	32	.25	6	.56	14	1.34	34	.37	9	.59	15
08914320	1.00	.93 - 1.06	24 - 27	1.38	35	.25	6	.56	14	1.34	34	.43	11	.56	14
08914330	1.25	1.16 - 1.43	29 - 36	1.75	44	.38	10	.75	19	1.78	45	.62	16	.81	21
08914340	1.50	1.58 - 1.75	40 - 44	2.00	51	.38	10	.75	19	1.78	45	.62	16	.72	18
08914350	1.75	1.72 - 1.85	44 - 47	2.25	57	.38	10	.75	19	1.78	45	.62	16	.72	18
08914360	2.00	1.97 - 2.12	50 - 54	2.50	64	.38	10	.75	19	2.50	64	.87	22	1.23	31

All Clevis Head Innerduct Pulling Eyes are compatible with all Condux pulling harness legs.

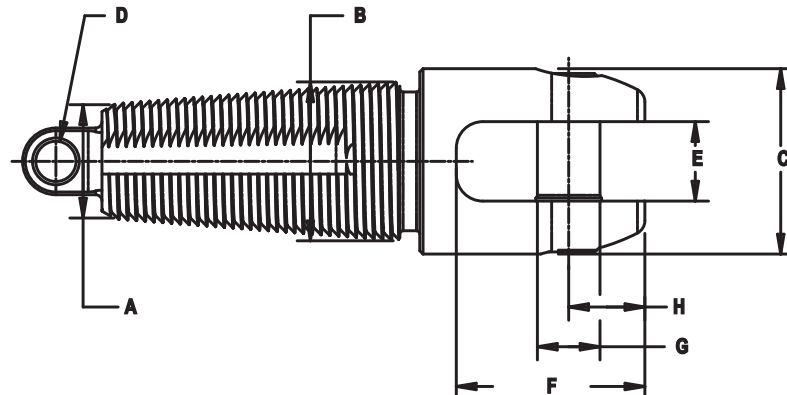



INNERDUCT PULLING PRODUCTS



! See compatibility chart on page 61 to determine what Innerduct Pulling Eyes work with various standard innerduct sizes.

Fixed Head Innerduct Pulling Eye

Tapered buttress threads thread into the innerduct for maximum pulling strength. These eyes connect directly to a Condux swivel (see page 34). When properly sized and installed, these eyes will not pull out of the innerduct until the pulling tensions have greatly exceeded the maximum pulling tensions recommended by the innerduct manufacturers.

NOTE: To determine correct pulling eye size, obtain the actual innerduct inside diameter (I.D.). The I.D. measurement must be greater than dimension A and smaller than dimension B.

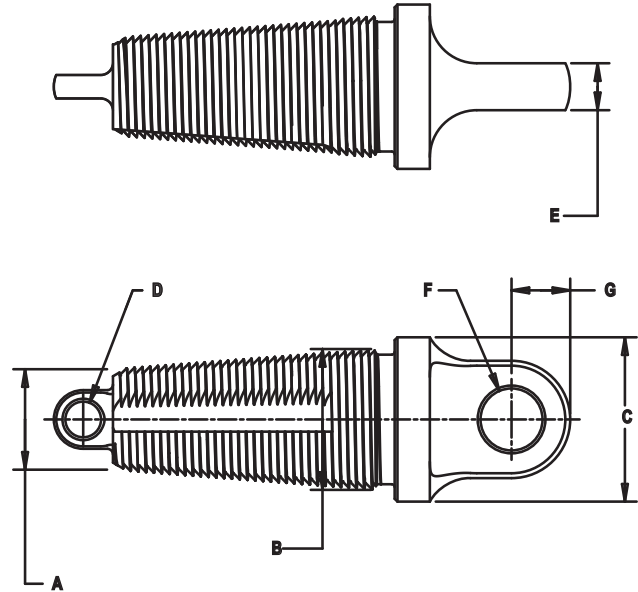

Part Number	Nominal Size	Innerduct ID Range		Max OD C		Hole Diameter D		Tang Thickness E		Tang Hole Diameter F		Tang Hole Location G	
	(IN.)	A - B (IN.)	A - B (MM)	(IN.)	MM	(IN.)	MM	(IN.)	(MM)	(IN.)	(MM)	(IN.)	(MM)
08914110 *	0.75	.73 - .94	19 - 24	1.25	32	.25	6	.38	10	.50	13	.50	13
08914120 *	1.00	.93 - 1.06	24 - 27	1.38	35	.25	6	.38	10	.50	13	.50	13
08914130 *	1.25	1.16 - 1.43	29 - 36	1.75	44	.38	10	.50	13	.66	17	.63	16
08914140 *	1.50	1.58 - 1.75	40 - 44	2.00	51	.38	10	.50	13	.66	17	.63	16
08914150 **	1.75	1.72 - 1.85	44 - 47	2.25	57	.38	10	.50	13	.66	17	.75	19
08914160 **	2.00	1.97 - 2.12	50 - 54	2.50	64	.38	10	.50	13	.81	21	.75	19

* Compatible with 1/4"-3/8" Threaded Chain Connectors and Condux Swivels 08080912, 08080913, 08210012, and 08210014

** Compatible with 5/16"-1/2" Threaded Chain Connectors and Condux Swivels 08210012 and 08210014

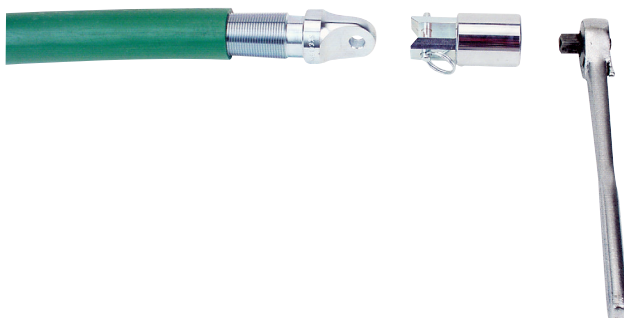

Innerduct Pulling Eye Installation Tool

Fits on a 1/2" drive ratchet (not included) to facilitate insertion of the eye into the innerduct.

Part Number	Description
08913335	Installation Tool



INNERDUCT PULLING PRODUCTS



Innerduct Compatibility Chart

Use the chart to determine which Innerduct Pulling Eyes work with the different sizes of innerduct.

	Innerduct Eye Part No.	Innerduct I.D. Range	Compatible Innerduct					
			0.75"	1.00"	1.25"	1.50"	2.00"	
Swivel Head	08960712	1.06"-1.43" (27 mm-36 mm)	-	SDR 13.5 SDR 15.5 SDR 17 SDR 21	SDR 7 SDR 9 SDR 11 SDR 13.5	SDR 7	-	
	08960715	1.37"-1.68" (35 mm-42 mm)	-	-	SDR 13.5 SDR 15.5 SDR 17 SDR 21	SDR 9 SDR 11 SDR 13.5 SDR 15.5	-	
	08960720	1.93"-2.12" (49 mm-54 mm)	-	-	-	-	SDR 13.5 SDR 15.5 SDR 17	
Fixed Head	Clevis Head	08914110	08914310	.73"-.94" (19 mm-24 mm)	SDR 9 SDR 11 SDR 13.5 SDR 15.5	-	-	-
		08914120	08914320	.93"-1.06" (24 mm-27 mm)	-	SDR 7 SDR 9 SDR 11	-	-
		08914130	08914330	1.16"-1.43" (29 mm-36 mm)	-	SDR 21	SDR 7 SDR 9 SDR 11 SDR 13.5	-
		08914140	08914340	1.58"-1.75" (40 mm-44 mm)	-	-	SDR 21	SDR 13.5 SDR 15.5 SDR 17 SDR 21
		08914150	08914350	1.72"-1.85" (44 mm-47 mm)	-	-	-	SDR 21
		08914160	08914360	1.97"-2.12" (50 mm-54 mm)	-	-	-	-

PULLING EYES & ACCESSORIES

CTS Gas Pipe Pulleys

Tapered buttress threads thread into the gas pipe for maximum pulling strength. These eyes connect directly to a Condux Breakaway Swivel (compatible with Condux 5/8" Breakaway Swivel only). When properly sized and installed, these eyes will not pull out of the gas pipe until the pulling tensions have greatly exceeded the maximum pulling tensions recommended by the gas pipe manufacturers.

Part Number	Description	Dimension
08914005	1/2 Inch CTS Gas Pipe Pulley	.315"-.551" (8 mm-14 mm)
08914007	3/4 Inch CTS Gas Pipe Pulley	.551"-.813" (14 mm-21 mm)
08914010	1 Inch CTS Gas Pipe Pulley	.813"-.1.05" (21 mm-27 mm)

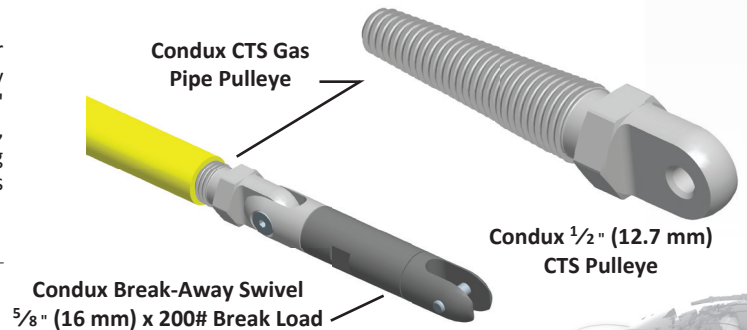

Innerduct Eyes for Micro Duct

Tapered buttress threads into the micro duct for maximum pulling strength.

Part Number	Description
08913547	Innerduct Eyes for Micro Duct (5-9 mm ID)
08913545	Innerduct Eyes for Micro Duct (10-13 mm ID)
08913538	Innerduct Eyes for Micro Duct (13-15 mm ID)





PULLING EYE SYSTEMS



Reusable Power Cable Pulling Eyes

Condux non-crimp Reusable Cable Pulling Eyes waste virtually no cable and all components are completely reusable. These eyes will remain firmly secured on the cable for a confident pull. No special tools or crimpers are required for installation.

Three designs of Reusable Power Pulling Eyes are available: Clevis Head, Standard Head, and Swivel Head.

For ease of ordering and cost savings, kits are available for Clevis, Swivel and Standard Head Reusable Eyes. See pages 62 - 64 for information.

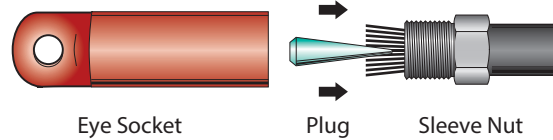

Reusable Power Pulling Eyes, Clevis Head

The Clevis Head Power Pulling Eyes feature a slotted head with clevis pin to allow direct attachment to a Condux multiple pulling harness. When pulling multiple cables into a single conduit, the conductors can be attached to a harness and installation is simplified to a single pull of one assembly. Each Clevis Head Power Pulling Eye includes a clevis socket, sleeve nut, and plug.

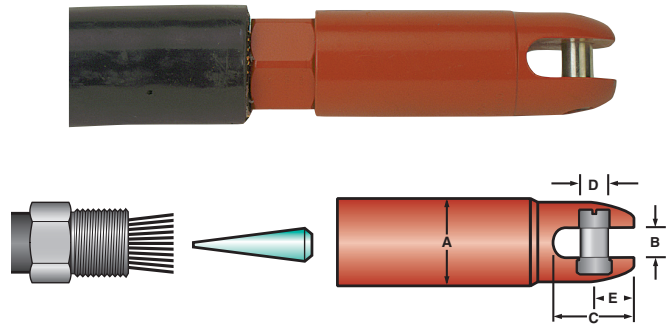

Part Number	Cable Size	Color	Maximum Conductor Diameter		Max Eye OD A		Slot Width B		Slot Depth C		Pin Diameter D		Pin Center E		Replacement Plug Part Number	Load Rating	
			(IN.)	(MM)	(IN.)	(MM)	(IN.)	(MM)	(IN.)	(MM)	(IN.)	(MM)	(IN.)	(MM)		LBS	KG
08918150*	2500 kcmil	Green	1.824	46	3.00	76	1.00	25	2.80	71	.88	22	1.23	31	08918123	25000	11340
08918050*	2000 kcmil	Red	1.601	41	2.50	64	1.00	25	2.80	71	.88	22	1.23	31	08918023	25000	11340
08917750*	1750 kcmil	Yellow	1.526	39	2.50	64	1.00	25	2.80	71	.88	22	1.23	31	08917723	25000	11340
08917950*	1500 kcmil	Black	1.412	36	2.38	60	.75	19	1.78	45	.63	16	.72	18	08917923	15000	6804
08917850*	1250 kcmil	Blue	1.289	33	2.25	57	.75	19	1.78	45	.63	16	.72	18	08917823	15000	6804
08917150*	1000 kcmil	Orange	1.152	29	2.06	52	.75	19	1.78	45	.63	16	.72	18	08917123	15000	6804
08917250*	750 kcmil	Brown	.998	25	1.75	44	.63	16	1.59	40	.56	14	.78	20	08917223	10000	4536
08917350*	700 kcmil	Gray	.964	24	1.75	44	.63	16	1.59	40	.56	14	.78	20	08917323	10000	4536
08918250*	600 kcmil	Green	.937	24	1.75	44	.63	16	1.59	40	.56	14	.78	20	08918223	10000	4536
08917450*	500 kcmil	Yellow	.813	21	1.44	37	.59	15	1.41	36	.44	11	.59	15	08917423	7000	3175
08918350*	400 kcmil	Black	.713	18	1.44	37	.59	15	1.41	36	.44	11	.59	15	08918323	5000	2268
08917550*	350 kcmil	White	.681	17	1.25	32	.56	14	1.34	34	.38	10	.59	15	08917523	2500	1134
08960350**	250 kcmil	Blue	.575	15	1.13	29	.38	10	1.06	27	.31	8	.53	13	08960323	2500	1134
08960450**	4/0 AWG	Green	.528	13	1.00	25	.38	10	1.06	27	.31	8	.53	13	08960423	2500	1134
08960950**	3/0 AWG	Orange	.475	12	1.00	25	.38	10	1.06	27	.31	8	.53	13	08960923	2500	1134
08960850**	2/0 AWG	Black	.419	11	1.00	25	.38	10	1.06	27	.31	8	.53	13	08960823	2500	1134
08960550**	1/0 AWG	Red	.373	9	0.88	22	.38	10	1.06	27	.31	8	.53	13	08960523	2500	1134

* - Compatible with all Condux pulling harness legs.

** - Compatible with 3/8" (3 mm) and 1/4" (6 mm) Condux pulling harness legs.

Will not work on flat aluminum stranded conductor.



Reusable Power Pulling Eyes, Standard Head

The Standard Head Power Pulling Eyes are an excellent alternative when pulling multiple cables into a single conduit. Single conductors can be attached to a Condux Multiple Pulling Harness with links or with Condux swivels. Installation is then simplified to a single pull of one assembly. Each Standard Power Pulling Eye includes an eye socket, sleeve nut, and plug.

For swivel compatibility, refer to compatibility chart on page 37.

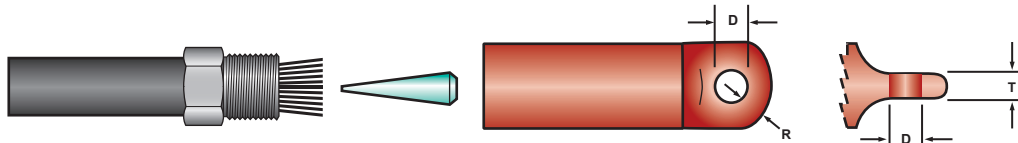

Part Number	Cable Size	Color	Maximum Conductor Diameter		Max Eye OD		Hole Diameter D		Eye Thickness T		Eye Width R		Replacement Plug Part Number	Working Load	
			(IN.)	(MM)	(IN.)	(MM)	(IN.)	(MM)	(IN.)	(MM)	(IN.)	(MM)		LBS	KN
08918455	6000 kcmil	Orange	2.785	71	4.50	114	1.31	33	1.50	38	1.22	31	08918423	59,000	262.4
08918440	5000 kcmil	White	2.500	64	4.50	114	1.31	33	1.50	38	1.22	31	08918423	59,000	262.4
08918450	4000 kcmil	Yellow	2.220	56	4.00	102	1.25	32	1.50	38	1.25	32	08918423	42,500	189.0
08918445	3500 kcmil	Black	2.160	55	4.00	102	1.25	32	1.50	38	1.25	32	08918423	42,500	189.0
08918430	3000 kcmil	Gray	2.030	52	4.00	102	0.88	22	.94	24	.81	21	08918423	26,000	115.6
08918585	2750 kcmil	White	1.964	50	4.00	102	0.88	22	.94	24	.81	21	08918423	26,000	115.6
08918580	2500 kcmil	Green	1.923	49	4.00	102	0.88	22	.94	24	.81	21	08918123	26,000	115.6
08918575	2000 kcmil	Red	1.700	43	2.63	67	1.00	25	.88	22	.75	19	08918023	25,000	111.2
08918570	1750 kcmil	Yellow	1.625	41	2.63	67	1.00	25	.88	22	.75	19	08917723	25,000	111.2
08918565	1500 kcmil	Black	1.469	37	2.63	67	1.00	25	.88	22	.75	19	08917923	25,000	111.2
08918560	1250 kcmil	Blue	1.328	34	2.63	67	1.00	25	.88	22	.75	19	08917823	25,000	111.2
08918555	1000 kcmil	Orange	1.203	31	2.00	51	0.69	17	.63	16	.59	15	08917123	13,500	60.0
08918550	750 kcmil	Brown	1.031	26	2.00	51	0.69	17	.63	16	.59	15	08917223	13,500	60.0
08918545	700 kcmil	Gray	1.00	25	2.00	51	0.69	17	.63	16	.59	15	08917323	13,500	60.0
08918540	600 kcmil	Green	.906	23	2.00	51	0.69	17	.63	16	.59	15	08918223	13,500	60.0
08918535	500 kcmil	Yellow	.843	21	1.88	48	0.69	17	.50	13	.59	15	08917423	8,500	37.8
08918530	400 kcmil	Black	.750	19	1.88	48	0.69	17	.50	13	.59	15	08918323	8,500	37.8
08918525	350 kcmil	White	.718	18	1.88	48	0.69	17	.50	13	.59	15	08917523	8,500	37.8
08918520	250 kcmil	Blue	.640	16	1.25	32	0.50	13	.50	13	.38	10	08960323	6,500	28.9
08918515	4/0 AWG	Green	.531	13	1.25	32	0.50	13	.50	13	.38	10	08960423	6,500	28.9
08918510	3/0 AWG	Orange	.475	12	1.25	32	0.50	13	.50	13	.38	10	08960923	6,500	28.9
08918505	2/0 AWG	Black	.431	11	1.25	32	0.50	13	.50	13	.38	10	08960823	6,500	28.9
08918500	1/0 AWG	Red	.390	10	1.25	32	0.50	13	.50	13	.38	10	08960523	6,500	28.9

3:1 Safety Factor

! Will not work on flat aluminum stranded conductor.





PULLING EYE SYSTEMS

Reusable Power Pulling Eyes, Swivel Head

The Swivel Head Power Pulling Eye is a hybrid tool that combines features from standard reusable power pulling eyes and Condux swivels for superior performance. A swivel head prevents twisting and binding of the cable as it is installed. It eliminates the need for a separate swivel on each pulling eye when installing single cables into individual conduits or multiple cables into a single conduit. Each Swivel Head Power Pulling Eye includes a swivel head, sleeve nut, and plug.

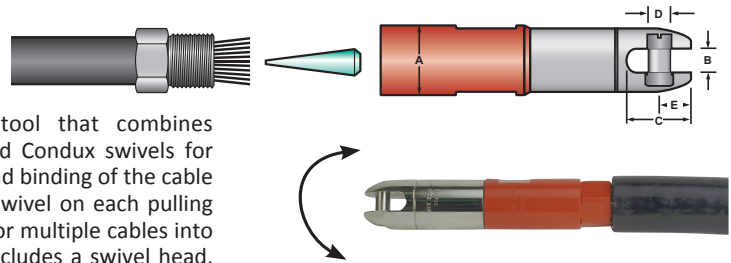

Part Number	Cable Size	Color	Maximum Conductor Diameter		Max Eye OD A		Slot Width B		Slot Depth C		Pin Diameter D		Pin Center E		Replacement Plug Part Number	Load Rating	
			(IN.)	(MM)	(IN.)	(MM)	(IN.)	(MM)	(IN.)	(MM)	(IN.)	(MM)	(IN.)	(MM)		LBS	KG
08918175*	2500 kcmil	Green	1.824	46	3.00	76	1.00	25	2.80	71	.88	22	1.23	31	08918123	25000	11340
08918075*	2000 kcmil	Red	1.601	41	2.50	64	1.00	25	2.80	71	.88	22	1.23	31	08918023	25000	11340
08917775*	1750 kcmil	Yellow	1.526	39	2.50	64	1.00	25	2.80	71	.88	22	1.23	31	08917723	25000	11340
08917975*	1500 kcmil	Black	1.412	36	2.38	60	.75	19	1.78	45	.63	16	.72	18	08917923	15000	6804
08917875*	1250 kcmil	Blue	1.289	33	2.25	57	.75	19	1.78	45	.63	16	.72	18	08917823	15000	6804
08917175*	1000 kcmil	Orange	1.152	29	2.06	52	.75	19	1.78	45	.63	16	.72	18	08917123	15000	6804
08917275*	750 kcmil	Brown	.998	25	1.75	44	.63	16	1.59	40	.56	14	.78	20	08917223	10000	4536
08917375*	700 kcmil	Gray	.964	24	1.75	44	.63	16	1.59	40	.56	14	.78	20	08917323	10000	4536
08918275*	600 kcmil	Green	.9367	24	1.75	44	.63	16	1.59	40	.56	14	.78	19	08918223	10000	4536
08917475*	500 kcmil	Yellow	.813	21	1.44	37	.56	14	1.31	33	.44	11	.56	14	08917423	10000	4536
08918375*	400 kcmil	Black	.7125	18	1.44	37	.56	14	1.31	33	.44	11	.56	14	08918323	7000	3175
08917575*	350 kcmil	White	.681	17	1.25	32	.56	14	1.34	34	.38	10	.59	15	08917523	5000	2268
08960375**	250 kcmil	Blue	.575	15	1.13	29	.38	10	1.03	26	.31	8	.53	13	08960323	2500	1134
08960475**	4/0 AWG	Green	.528	13	1.00	25	.38	10	1.03	26	.31	8	.53	13	08960423	2500	1134
08960975**	3/0 AWG	Orange	.475	12	1.00	25	.38	10	1.03	26	.31	8	.53	13	08960923	2500	1134
08960875**	2/0 AWG	Black	.419	11	1.00	25	.38	10	1.03	26	.31	8	.53	13	08960823	2500	1134
08960575**	1/0 AWG	Red	.373	10	.88	22	.38	10	1.03	26	.31	8	.53	13	08960523	2500	1134

* - Compatible with all Condux pulling harness legs.

** - Compatible with 3/8" (3 mm) and 1/2" (6 mm) Condux pulling harness legs.

Will not work on flat aluminum stranded conductor.

Reusable Power Pulling Eye Kits

For cost savings and ease of ordering, Condux has prepared kits for the Clevis, Standard, and Swivel Head Reusable Power Pulling Eyes.



Clevis Head Kits

Part Number	Description
08917010	Kit for 350 to 1000 kcmil power pulling eyes with clevis ends. Includes 3 each of the eyes for 350 to 1000 kcmil cable. NOTE: Does not include 400 or 600kcmil.
08917060	Kit for 1/0 AWG to 250 kcmil power pulling eyes with clevis ends. Includes three each of the eyes for 1/0 AWG to 250 kcmil cable. NOTE: Does not include 3/0 AWG.

Standard Head Kits

Part Number	Description
08918595	Kit for 350 to 1000 kcmil power pulling eyes with eye ends. Includes three each of the eyes for 350 to 1000 kcmil cable. NOTE: Does not include 400 or 600kcmil.
08918590	Kit for 1/0 AWG to 250 kcmil power pulling eyes with eye ends. Includes three each of the eyes for 1/0 AWG to 250 kcmil cable. NOTE: Does not include 3/0 AWG.

Swivel Head Kits

Part Number	Description
08917030	Kit for 350 to 1000 kcmil power pulling eyes with swivel ends. Includes three each of the eyes for 350 to 1000 kcmil cable. NOTE: Does not include 400 or 600kcmil.
08917080	Kit for 1/0 AWG to 250 kcmil power pulling eyes with swivel ends. Includes three each of the eyes for 1/0 AWG to 250 kcmil cable. NOTE: Does not include 3/0 AWG.

Replacement Case

Part Number	Description
08917086	Replacement case is available for the Reusable Power Pulling Eyes. This case includes a foam insert for the storage of the power pulling eyes.



CABLE PULLING LUBRICANT



Crimp-On Cable Pulling Eyes and Accessories

! Visit www.condux.com for product literature.

Condux Crimp-On Cable Pulling Eyes for telephone and power cable are the ultimate solution in cable pulling eyes. These pulling eyes form a connection as strong as the cable itself. The entire cable, jacket and conductor is used which reduces the risk of cable deformation during pulling. When properly installed, Crimp-On Pulling Eyes are virtually impossible to pull off and also seal the cable against both water and air intrusion. Typically factory installed, the pulling eyes can also be field installed with a special crimping tool, available from Condux.

The Condux Crimp-On Cable Pulling Eyes Catalog, available online at www.condux.com, lists complete information on different styles of pulling eyes available and serves as an ordering guide. Minimum order quantities apply.



Crimp-on Pulling Eye Crimper Kit and Accessories

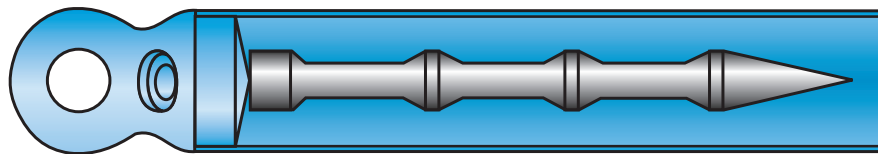

Polywater® Lubricant J

Polywater® Lubricant J is a high performance, clean, slow-drying, water-based gel. Lubricant J provides maximum tension reduction in all types of cable pulling. It is especially recommended for long pulls, multiple-bend pulls and pulls in hot environments. Lubricant J dries to form a thin lubricating film that retains its slipperiness for months after use. It is harmless to humans, environmentally safe, compatible with all cable jacket materials and easily applied.

Part Number	Description	Min. Order Qty.
08230300	1 Quart (.9 liter) Squeeze Bottle	12 Quarts
08230310	½ Gallon (1.9 liter) Poly Bag (in Pail)	10 Bags (in 1 Pail)
08230301	1 Gallon (3.8 liter) Pail	4 Pails
08230305	5 Gallon (19 liter) Pourable Pail	1 Pail
08230355	55 Gallon (208 liter) Drum	1 Drum



Polywater® Lubricant WJ

Lubricant WJ is a non-freezing form of the standard Lubricant J for power applications.

Part Number	Description	Min. Order Qty.
08230400	1 Quart (.9 liter) Squeeze Bottle	12 Quarts
08230410	½ Gallon (1.9 liter) Poly Bag (in Pail)	10 Bags (in 1 pail)
08230401	1 Gallon (3.8 liter) Jug	4 Jugs
08230405	5 Gallon (19 liter) Pourable Pail	1 Pail
08230455	55 Gallon (208 liter) Drum	1 Drum

Polywater® Lubricant PJ

Polywater® Lubricant PJ is a pourable version of the Polywater® Lubricant J. It offers the same proven features as Polywater® Lubricant J in key areas such as lubricity, cable compatibility and easy clean-up, yet is easier to apply where pouring is practical.

Part Number	Description	Min. Order Qty.
08230501	1 Gallon (3.8 liter) Jug	4 Jugs
08230504	2½ Gallon (9.5 liter) Jug	2 Jugs
08230505	5 Gallon (19 liter) Pourable Pail	1 Pail
08230555	55 Gallon (208 liter) Drum	1 Drum



PULLING EYES & ACCESSORIES



CABLEGLIDER® LW CABLE PULLER

POWER CABLE INSTALLATION



CableGlider® LW

The Condux CableGlider LW offers portability and ease of set-up, one-person operation, in a completely self-contained unit to adapt to a variety of pulling situations. It comes equipped with a one speed motor and gearbox that provides up to 3,000 lbs (13,345 N) of pulling force.

Design features include a pivoting arm, split conduit adapters and a foot switch for operator convenience and safety, it is recommended that the CableGlider LW be used with 3/8" - 1/2" (9.5 mm - 12.7 mm) diameter rope.

CableGlider LW includes the following items:

- Puller
- Foot switch
- Fork
- Canvas carrying bag

Part Number	Description
08678200	CableGlider LW (Includes: Puller, Foot Switch, Fork & Canvas Bag)



**Adapters sold separately.
See page 68.**

Specifications		
PULLING FORCE	lbs	kN
Maximum	3,000	13
PULLING SPEED	ft/min	m/min
No Load	30	9
Power Requirements		
	115 VAC @ 9 AMPS Min.	
PEAK POWER	.95 HP (.708 KW)	
GENERATOR	3500 Watt Recommended	



1" - 5" Conduit Adapters



Adapters Split for Easy Removal

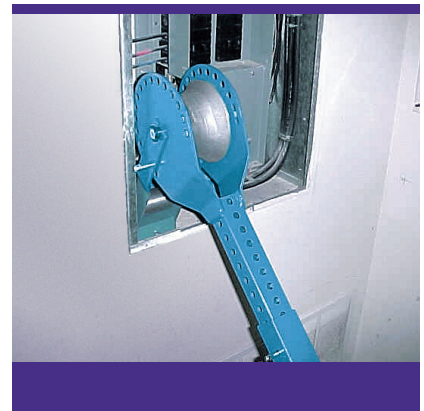

Retaining Fork



EXTENSION RANGE 67" to 87" (1.7 m - 2.2 m)

PULLER Grooved cast aluminum capstan provides better rope gripping

ELECTRIC MOTOR and gearbox provides up to 3000 lbs (13 kN) pulling force

FOOT SWITCH provides for operator convenience and safety

FORK rotates on head to accommodate different pulling situations

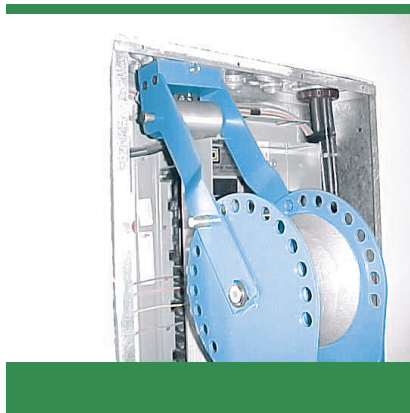
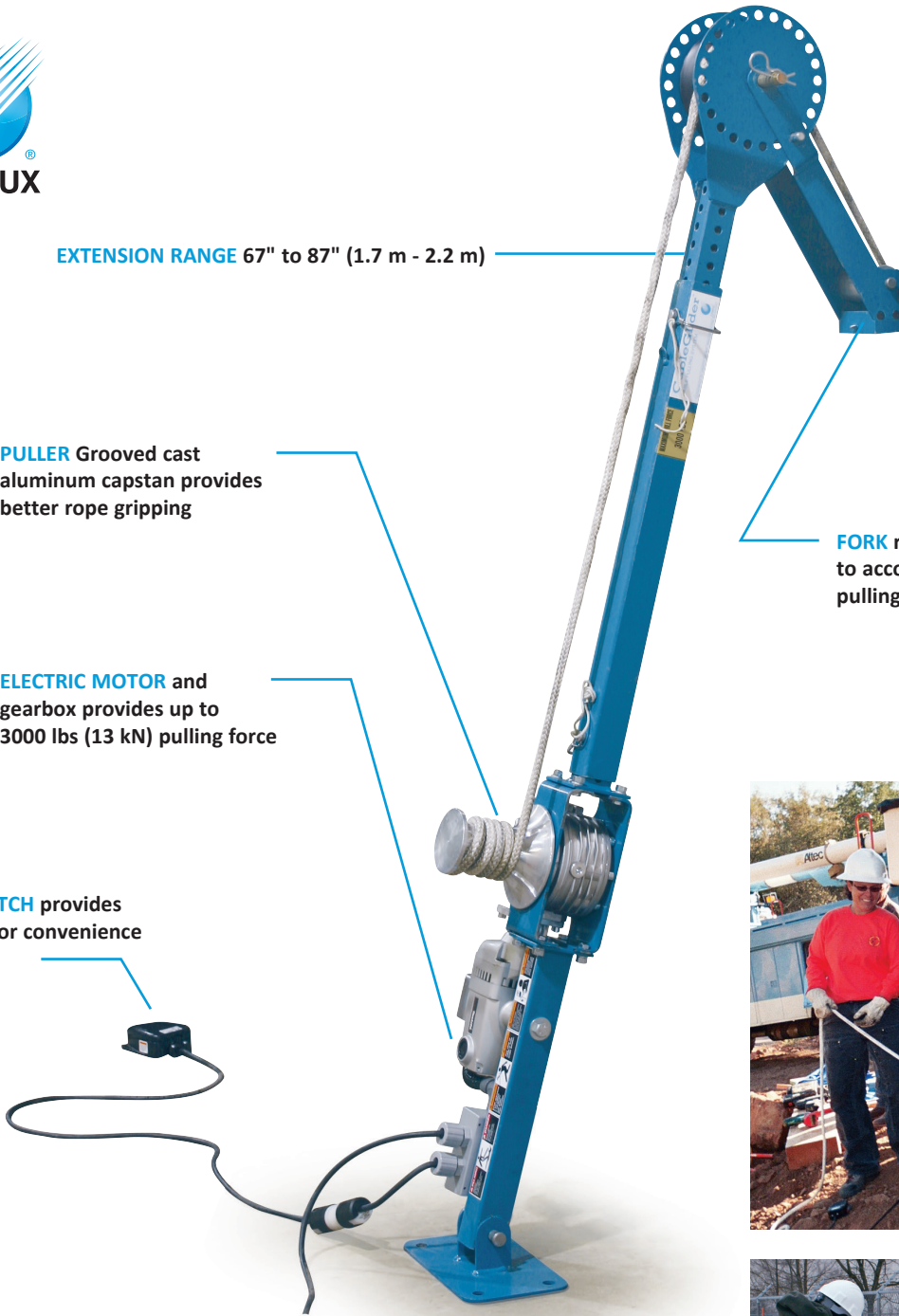

Can be used for Vertical or Horizontal Pulls





CABLEGLIDER® LW ACCESSORIES



CableGlider LW® Tripod

Pull an additional 5' (1.5 m) of slack with the Condux LW CableGlider Tripod.

NOTE: LW CableGlider sold separately.

Part No.	Description
08678350	3,000 lb (13,345 N) CG Tripod
08678370	3,000 lb (13,345 N) CG Tripod Retro Kit

LW Conduit Adapters

Adapters are available, which allow pulling into conduit up to 6" (152 mm). The external adapters are designed to fit the OD of the conduit, while the internal adapters, when used with the external adapters, fit the ID of the conduit. All adapters come split for easy removal.



LW External Adapters

Part Number	Description
08678240	External Adapter, 1.00" (25 mm) Conduit
08678245	External Adapter, 1.25" (32 mm) Conduit
08678250	External Adapter, 1.50" (38 mm) Conduit
08678255	External Adapter, 2.00" (51 mm) Conduit
08678260	External Adapter, 2.50" (64 mm) Conduit
08678265	External Adapter, 3.00" (76 mm) Conduit
08678270	External Adapter, 3.50" (89 mm) Conduit
08678275	External Adapter, 4.00" (102 mm) Conduit
08678300	External Adapter, 5.00" (127 mm) Conduit
08678330	External Adapter, 6.00" (152 mm) Conduit



LW Internal Adapters (Requires External Adapters)

Part Number	Description
08678276	Internal Adapter, 1.00" (25 mm) Conduit
08678277	Internal Adapter, 1.25" (32 mm) Conduit
08678278	Internal Adapter, 1.50" (38 mm) Conduit
08678279	Internal Adapter, 2.00" (51 mm) Conduit
08678280	Internal Adapter, 2.50" (64 mm) Conduit
08678281	Internal Adapter, 3.00" (76 mm) Conduit
08678282	Internal Adapter, 3.50" (89 mm) Conduit
08678283	Internal Adapter, 4.00" (102 mm) Conduit
08678303	Internal Adapter, 2.00" (51 mm) Conduit Sch 80
08678304	Internal Adapter, 3.00" (76 mm) Conduit Sch 80
08678305	Internal Adapter, 4.00" (102 mm) Conduit Sch 80
08678306	Internal Adapter, 5.00" (127 mm) Conduit Sch 80
08678324	Internal Adapter, 5.00" (127 mm) Conduit Sch 40
08678329	Internal Adapter, 6.00" (152 mm) Conduit Sch 80

For cost savings and ease of ordering, Condux has prepared kits for the CableGlider LW Adapters.

LW Adapter Kits

Part Number	Description
08678307	External Adapter Kit, 1.00-4.00" (25-127 mm) Conduit
08678320	Internal Adapter Kit, 1.00-4.00" (25-127 mm) Conduit



CABLEGLIDER® LW ACCESSORIES

LW Extension Frame

The Extension Frame is ideal for pulling in handholes and pull boxes when added reach is necessary.

Part Number	Description
08678295	Extension Frame LW Puller



LW CableGlider Amp-Type Tensiometer

Monitors pull tension based on the number of amps the motor is drawing. Useful when superior accuracy is not required (Accuracy is ±20%) Amp usage is then translated into a tension reading shown on the display.

Part Number	Description
08674110	110 Volt Amp-Type Tensiometer (LW model)



Hitch Mount Adapter LW CableGlider®

Hitch Mount Adapters are a fast, easy way to mount the LW CableGlider. The Hitch Mount Adapter attaches directly into a typical 2" (51 mm) square Reese-type receiver.

Part Number	Description
08678217	LW Hitch Mount Adapter

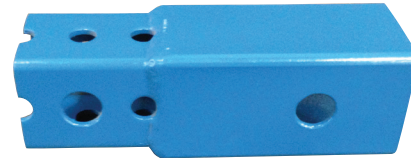

Floor/Conduit/Pole Mount Frame LW CableGlider®

Makes it possible to attach the CableGlider power pack to the floor, steel conduit, I-beams or a wood pole. Typically used where there is limited access for overhead pulling or pulling from pole risers. Floor mounting requires 3/8" or M16 fasteners, grade 5 or better.

NOTE: 24" (610 mm) diameter maximum pole.

WARNING: CableGlider Cable Pullers are not to be used as a hoist or for lifting, supporting or transporting people or loads.

Part Number	Description
08674000	Floor/Conduit/Pole Mount Frame LW CableGlider (Complete Kit)
08674001	Brackets, LW CableGlider
08674005	Floor/Conduit/Pole Mount Frame





CABLEGLIDER® CABLE PULLERS

POWER CABLE INSTALLATION



CableGlider® STD Cable Puller

The Condux CableGlider STD Cable Puller offers portability and ease of set-up in a completely self-contained unit to adapt to a variety of pulling situations. It comes equipped with a two-speed removable power pack, providing up to 6,500 pounds (28,913 N) of pulling force at low speed. Speed changes are no problem with just a turn of a dial.

Design features include a self-tailing capstan for added stability, a pivoting arm and a foot switch for operator convenience and safety. Accepts all diameter rope (self tailing capstan accepts 5/8" (16 mm) to 7/8" (22 mm) rope only).

CableGlider STD includes the following items:

- Puller
- Foot switch
- Retaining Fork
- Conduit Adapters (see pg. 77) - 2", 3", 3½", 4"
- Tool box for the accessories

Complete Pulling Packages include additional accessories along with the items listed above.



Typical CableGlider STD Applications

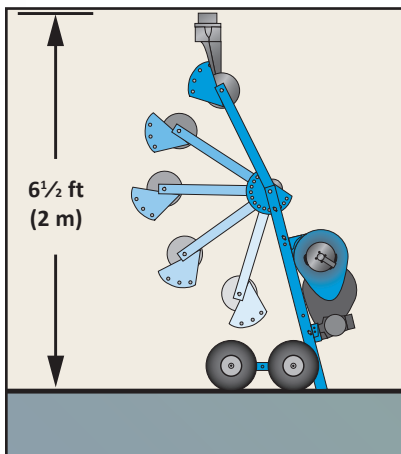

PIVOTING ARM

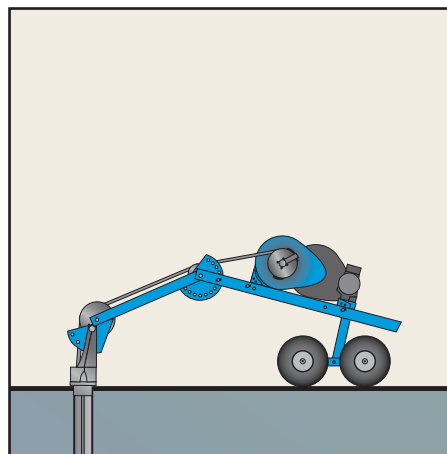

VERTICAL (UP) PULL FROM FLOOR

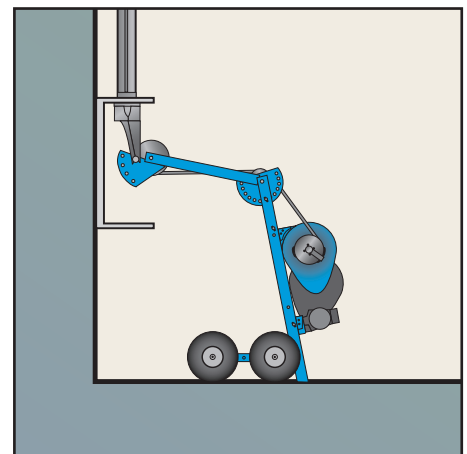

VERTICAL (DOWN) PULL FROM BOX



CONDEX

CABLEGLIDER® CABLE PULLERS



CableGlider STD

Part Number	Description
08610650	110 Volt Standard Cable Puller
08678025	220 Volt Standard Cable Puller*
08610650S	110 Volt Standard Cable Puller - Split Adapters
08678025S	220 Volt Standard Cable Puller - Split Adapters*

*Does not include a plug; customer must provide plug according to country code.

WARNING: CableGlider Cable Pullers are not to be used as a hoist or for lifting, supporting or transporting people or loads.

Complete Pulling Packages For CableGlider STD

Condux pulling packages offer cost savings and ordering convenience.

Part No.	Description
08674388	CableGlider STD (Package 1) <ul style="list-style-type: none"> • 110 Volt Puller with accessories • Standard Extension Frame (pg. 76) 08674940 • 600 ft. (183 m) of 5/8" (16 mm) double-braided rope (pg. 31) 08090906 • Floor/Conduit/Pole Mount Frame (pg. 75) 08674005 • 5" & 6" adapters w/retaining fork (pg. 77) 08610648 (5" adapter), 08610649 (6" adapter), 08674022 (re. fork) • Running Line Tensiometer with Chart Recorder (pg. 78) 08677350
08674388S	CableGlider STD (Package 1) Split All items listed above (08674388) included, except substitute split adapter and fork part numbers: 08611008 (5" adapter), 08611009 (6" adapter), 08611013 (re. fork)
08610686	CableGlider STD (Package 2) All items listed above (08674388) included, except substitute Running Line Tensiometer with Amp Type Tensiometer 08674100 (pg. 77)
08610686S	CableGlider STD (Package 2) Split All items listed in Package 1 Split (08674388S) included, except substitute Running Line Tensiometer with Amp Type Tensiometer 08674100 (pg. 77)



CableGlider STD Package 1

SPECIFICATIONS				
	Low Speed		High Speed	
PULLING FORCE	lbs	kN	lbs	kN
Maximum	6,500	28.9	3,500	15.6
Continuous	4,000	17.8	2,000	8.9
PULLING SPEED	ft/min	m/min	ft/min	m/min
No Load	17.5	5.3	39.2	12.0
At 2,000 lbs (8.9 kN)	13.5	4.1	18.8	5.7
At 4,000 lbs (17.8 kN)	9.5	2.9	—	—
At 6,000 lbs (26.7 kN)	7.0	2.1	—	—
Power Requirements				
08610650	115 VAC @ 10 Amps Minimum			
08678025	220 VAC @ 5 Amps Minimum			
PEAK POWER	1.9 HP (1.42 kW)			
GENERATOR	4000 Watt Recommended*			

*NOTE: Use of less than the recommended wattage generator may effect the pulling specifications listed above.

Transformer Volt Converter 4000 Watt

Use only with the STD CableGlider.

Part Number	Description
08674850	Transformer Volt Converter 4000 Watt

Features:

- 4000 Watt
- Heavy-Duty Continuous use Transformer
- One grounded outlet in front of unit (accepts 3 or 2 prong US and Euro Plugs)
- Converts 220/240 Volts down to 110/120 Volts
- Built-In Fuse Protection
- Hard-Wire with European Shucko Plug also good for Asian Outlets

POWER CABLE ISNTALLATION

Typical CableGlider STD Applications

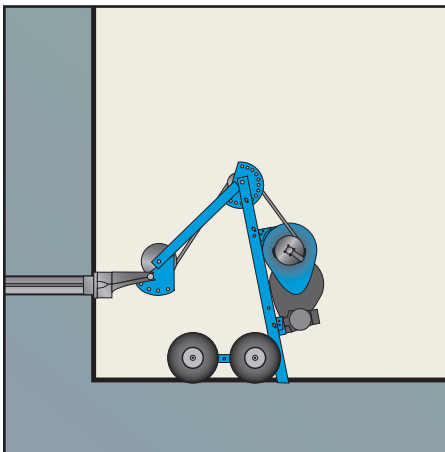

HORIZONTAL PULL

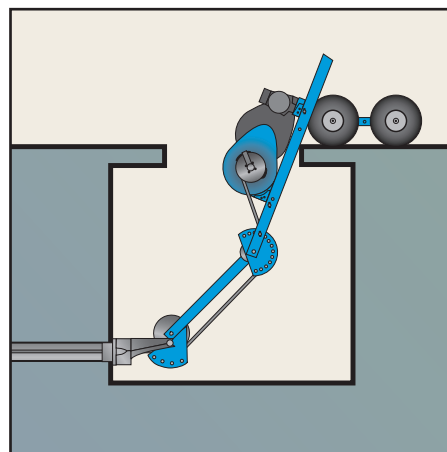

HORIZONTAL VAULT PULL

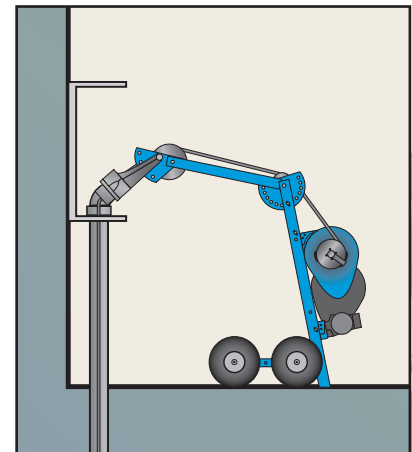

VERTICAL PULL WITH 45° ELBOW



CABLEGLIDER® CABLE PULLERS



CableGlider® HD Cable Puller

The Condux CableGlider HD is specially designed to provide maximum pulling power for longer runs in a completely self-contained unit. It offers fast set-up, portability and is easily adaptable for a variety of pulling situations.

The removable power pack delivers up to 12,000 lbs (53,379 N) of pulling force at low speed—over 80% more than our STD puller. The two-speed motor pulls up to 30 ft/min (9 m/min) at high speed and up to 15 ft/min (4.5 m/min) at low speed.

The CableGlider HD comes with a heavy-duty frame and extra pivoting arm. The front frame height can easily be adjusted with pins.

CableGlider HD includes the following items:

- Puller
- Foot switch
- Retaining Fork
- Conduit Adapters (see pg. 77) - 2", 3", 3½", 4"
- Tool box for the accessories

Complete Pulling Packages include additional accessories along with the items listed above.



Typical CableGlider HD Applications

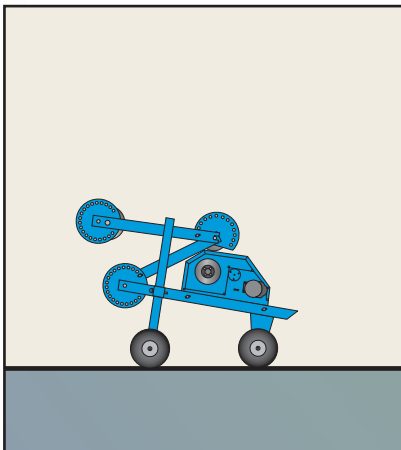

TRANSPORT POSITION

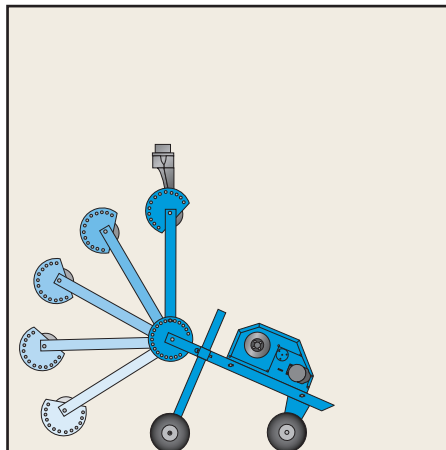

FIRST PIVOTING ARM

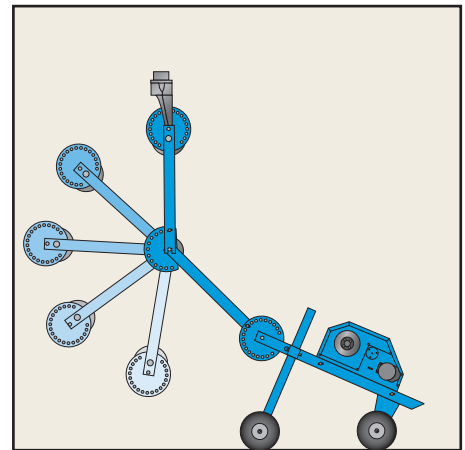

SECOND PIVOTING ARM



CABLEGLIDER® CABLE PULLERS



POWER CABLE ISNTALLATION

CableGlider HD

Part Number	Description
08674500	110 Volt HD Cable Puller with 20 amp twist plug
08674500S	110 Volt HD Cable Puller with 20 amp twist plug - Split Adapters

WARNING: CableGlider Cable Pullers are not to be used as a hoist or for lifting, supporting or transporting people or loads.

Complete Pulling Packages For CableGlider HD

Condux pulling packages offer cost savings and ordering convenience.

Part No.	Description
08674689	CableGlider HD (Package 1) <ul style="list-style-type: none"> • 110 Volt Puller with accessories • HD Extension Frame (pg. 76) 08674960 • 600 ft. (183 m) of 7/8" (22 mm) double-braided rope (pg. 31) 08091106 • Floor/Conduit/Pole Mount Frame (pg. 75) 08674010 • 5" & 6" adapters w/retaining fork (pg. 77) 08610648 (5" adapter), 08610649 (6" adapter), 08674022 (re. fork) • Running Line Tensiometer with Chart Recorder (pg. 79) 08677360
08674689S	CableGlider HD (Package 1) Split All items listed above (08674689) included, except substitute split adapter and fork part numbers: 08611008 (5" adapter), 08611009 (6" adapter), 08611013 (re. fork)
08674688	CableGlider HD (Package 2) All items listed above (08674689) included, except substitute Running Line Tensiometer with Amp Type Tensiometer 08674501 (pg. 77)
08674688S	CableGlider HD (Package 2) Split All items listed in Package 1 Split (08674689S) included, except substitute Running Line Tensiometer with Amp Type Tensiometer 08674501 (pg. 77)

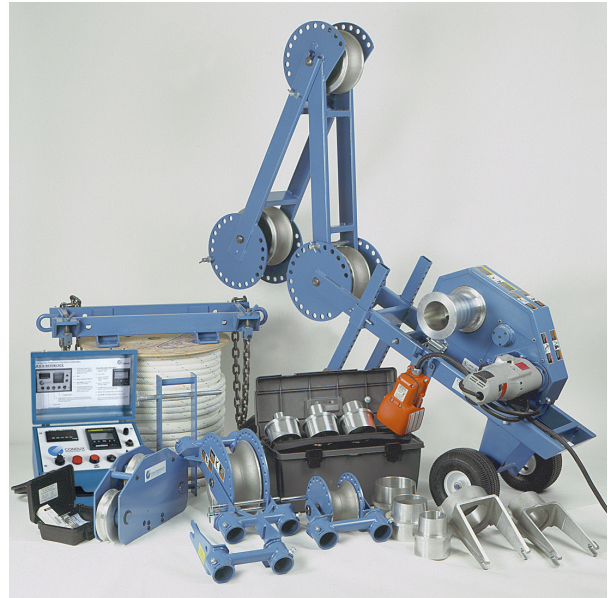

CableGlider HD Package 1

SPECIFICATIONS				
	Low Speed		High Speed	
	lbs	kN	lbs	kN
PULLING FORCE				
Maximum	12,000	53.4	6,000	26.7
Continuous	6,500	28.9	4,000	17.8
PULLING SPEED	ft/min	m/min	ft/min	m/min
No Load	20.1	6.1	40.9	12.5
At 4,000 lbs (17.8 kN)	14.5	4.4	26.5	8.1
At 6,000 lbs (26.7 kN)	11.2	3.4	—	—
At 10,000 lbs (44.5 kN)	9.4	2.9	—	—
Power Requirements				
08674500	115 VAC @ 20 Amps Min.			
PEAK POWER	4.7 HP (3.50 kW)			
GENERATOR	8000 Watt Recommended*			

*NOTE: Use of less than the recommended wattage generator may effect the pulling specifications listed above.

Typical CableGlider HD Applications

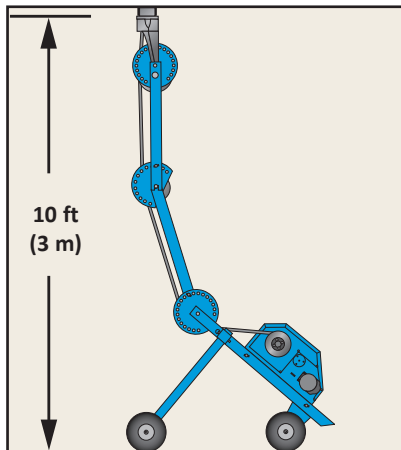

VERTICAL OVERHEAD PULL

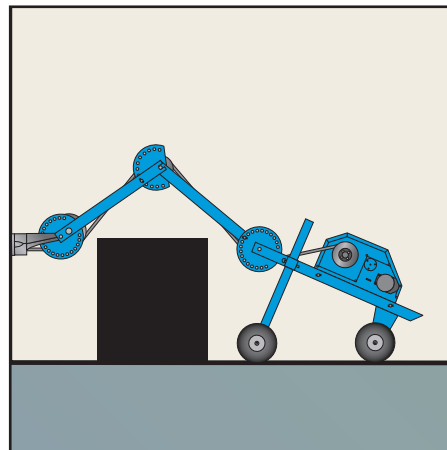

HORIZONTAL PULL
OVER OBSTRUCTION

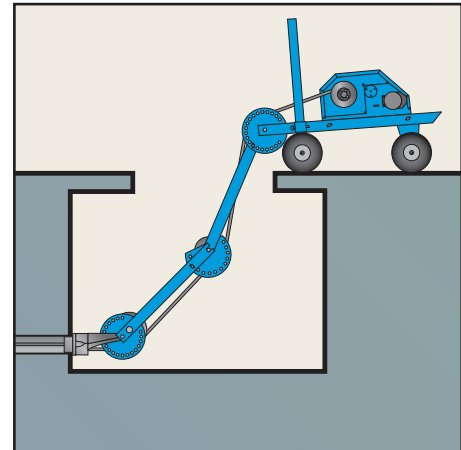

HORIZONTAL VAULT PULL



CABLEGLIDER® POWER PACKS & ACCESSORIES

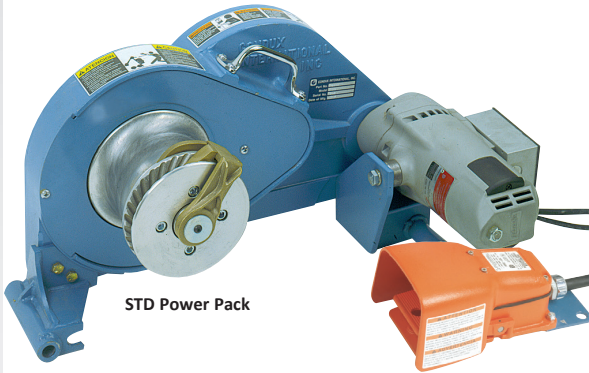

STD Power Pack



HD Power Pack

Power Packs

As an added measure of versatility and convenience, the Condux CableGlider® Power Packs can be purchased separately without the standard base frames provided with the CableGlider Cable Pullers. The power packs provide the same pulling capacities as the CableGlider Cable Pullers (see pages 70 to 73) and can be used on the Floor Mount Frame or the Floor/Conduit/Pole Mount Frames listed on page 75.

WARNING: CableGlider Cable Pullers are not to be used as a hoist or for lifting, supporting or transporting people or loads.

Part Number	Description
08610860	110 Volt STD Cable Puller Power Pack and Foot Control
08674680	110 Volt HD Cable Puller Power Pack and Foot Control
08610900	220/240 Volt STD Cable Puller Power Pack (EU Plug) and Foot Control
08610900-AU	220/240 Volt STD Cable Puller Power Pack (AU Plug) and Foot Control



Adjustable Manhole Adapter

Designed to work with CableGlider Cable Pullers, the Condux Adjustable Manhole Adapter allows greater stability and versatility for manhole pulls. The rugged aluminum frame provides an adjustable platform to fit 18" (457 mm) to 46" (1,168 mm) manholes.

Use the frame to position a cable puller above a manhole. Installation is easy, the fit is secure, and the strength is a maximum 12,000 lbs. (53,379 N).

Part Number	Description
08674750	Adjustable Manhole Adapter (comes standard with 4" plate)
08674752	6" Plate - Required when using 6" retaining fork (page 77)



CABLEGLIDER® ACCESSORIES



Floor Mount Frame

Fastens to the floor of a vault, manhole, or utility room. The power pack easily pins to the frame. Requires 5/8" or M16 fasteners, grade 5 or better.

WARNING: CableGlider Cable Pullers are not to be used as a hoist or for lifting, supporting or transporting people or loads.

Part Number	Description
08610620	Floor Mount Frame (STD model)
08674595	Floor Mount Frame (HD model)

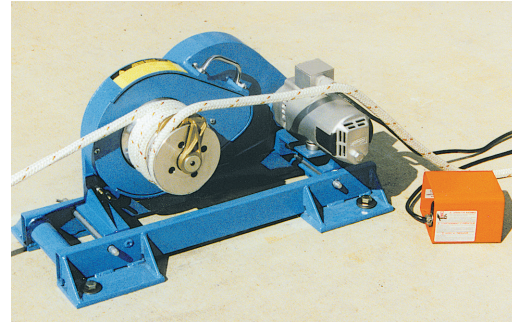

Floor/Conduit/Pole Mount Frame

Makes it possible to attach the power pack to the floor, steel conduit, I-beams or a wood pole. Typically is used where there is limited access for overhead pulling or pulling from pole risers. Floor mounting requires 5/8" or M16 fasteners, grade 5 or better.

NOTE: 24" (610 mm) diameter maximum pole.

WARNING: CableGlider Cable Pullers are not to be used as a hoist or for lifting, supporting or transporting people or loads.

Part Number	Description
08674005	Floor/Conduit/Pole Mount Frame (STD model)
08674010	Floor/Conduit/Pole Mount Frame (HD model)

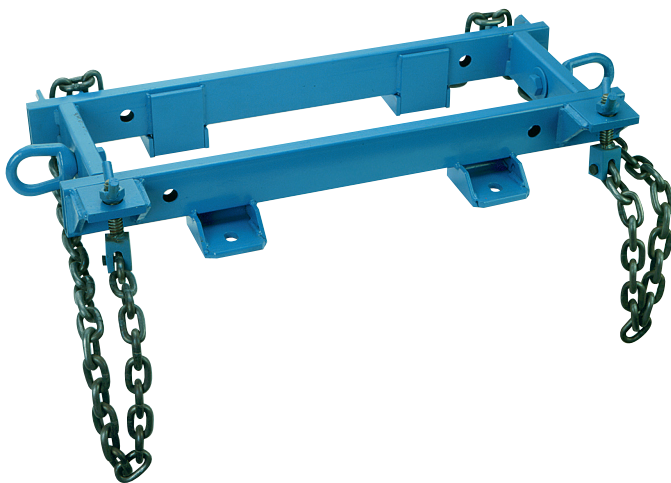

POWER CABLE ISNTALLATION





CABLEGLIDER® ACCESSORIES

POWER CABLE INSTALLATION

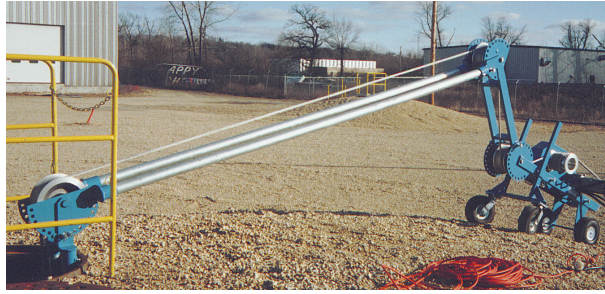

Extension Frame

Productivity reaches a new level with the Condux CableGlider® Cable Puller Extension Frame. Using only a few modular components, difficult pulling situations can have easy solutions.

Ideal for cable pulling in deep manholes where added reach is necessary. Also, high overhead ducts can be reached without compromising the stability of the cable puller.

Pull slack with the Extension Frame when extra reach is not needed. It actually adds length to the conduit run, allowing the cable puller to be positioned further back and more cable (slack) to be pulled through.

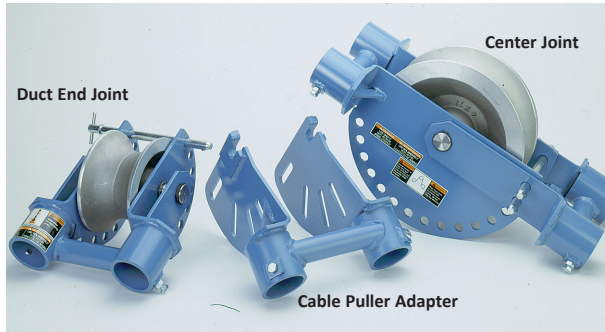

Extension Frame Kit for CableGlider STD Model

Extension Frames are available in kits that configure to Condux CableGlider Standard and Heavy Duty Cable Pullers. Each kit contains:

- Cable Puller Adapter
- Center Joint
- Duct End Joint

Steel duct (2" Sch 40 GRC) not included.

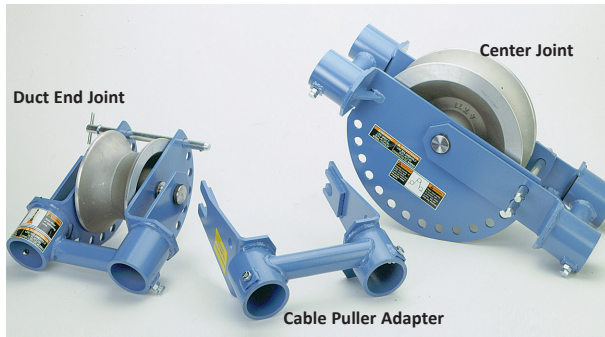

Extension Frame Kit for CableGlider HD Model

Extension Frame Kits

Part Number	Description
08674940	Kit for CableGlider STD model
08674960	Kit for CableGlider HD model

Replacement Parts/Individual Components

Part Number	Description
08674928	Puller Adapter for CableGlider STD model
08674927	Puller Adapter for CableGlider HD model
08674916	Center Joint for CableGlider STD and HD models
08674901	Duct End Joint for CableGlider STD and HD models



Center Joint

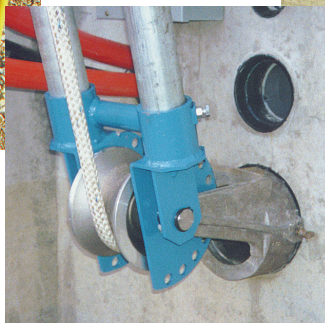

Duct End Joint

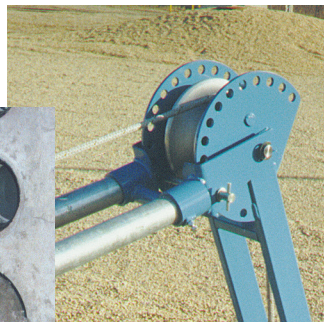

Cable Puller Adapter

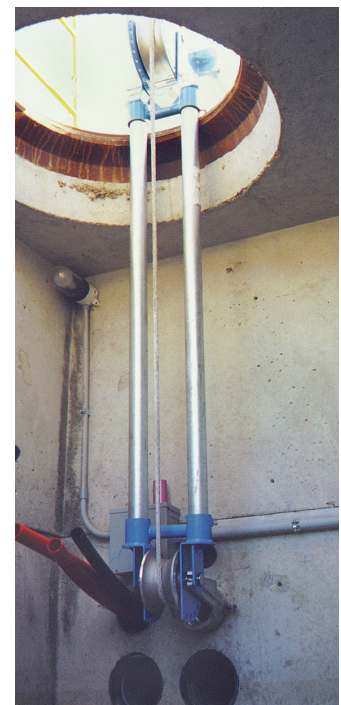



CABLEGLIDER® ACCESSORIES



POWER CABLE ISNTALLATION

Conduit Adapters

Additional adapters are available which allow pulling into conduit up to 6" in size. The 5" and 6" adapters require the use of an optional retaining fork.

Adapters for 2", 3", 3½", and 4" conduit are included in a tool box that comes standard with all cable pullers. Order additional adapters separately below, or order a complete toolbox.

Duct Size (in)	Straight Adapter Part Number	Split Adapter Part Number
1¼	08610642	08611001
1½	08610623	08611002
2	08610643*	08611003+
2½	08610647	08611004
3	08610644*	08611005+
3½	08610645*	08611006+
4	08610646*	08611007+
5	08610648	08611008
6	08610649	08611009



Accessories

Part #	Description
02276000*+	Tool box only for accessories
08674021*	Retaining fork for 2"-4" conduit adapters
08611012+	Split adapter retaining fork for 2"-4" conduit adapters
08674022	Retaining fork for 5"-6" conduit adapters
08611013	Split adapter retaining fork for 5"-6" conduit adapters
08674017	Complete tool box. Includes all six (*) items above
08611020	Complete tool box for split adapters. Includes all six (+) items above

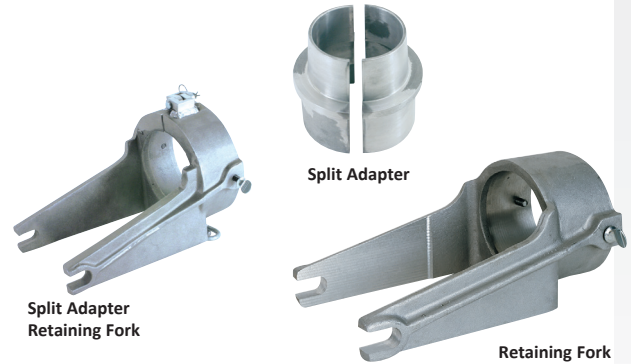

Elbow Adapter

Use in junction or meter boxes. Allows the conduit adapter to fully seat when there isn't room for the retaining fork and puller frame.

Part Number	Description
08674014	4" 45° Elbow adapter
08611011	4" 45° Split Elbow adapter



Extension Cords

Part Number	Description
08677325	120 Volt, 20 Amp twist 25' (7.6 m) Extension cord
08677330	120 Volt, 20 Amp twist 100' (30 m) Extension cord

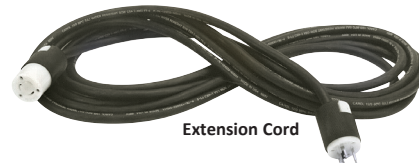

Amp-Type Tensiometer

Monitors pull tension based on the number of amps the motor is drawing. Useful when superior accuracy is not required (Accuracy is ±20%). Amp usage is then translated into a tension reading shown on the display.

Part Number	Description
08674100	110 Volt Amp-Type Tensiometer (STD model)
08674501	110 Volt Amp-Type Tensiometer (HD model)
08674502	220/240 Volt Amp-Type Tensiometer (STD model)
08674502-AU	220/240 Volt Amp-Type Tensiometer AU (STD model)





RUNNING LINE TENSIO METER

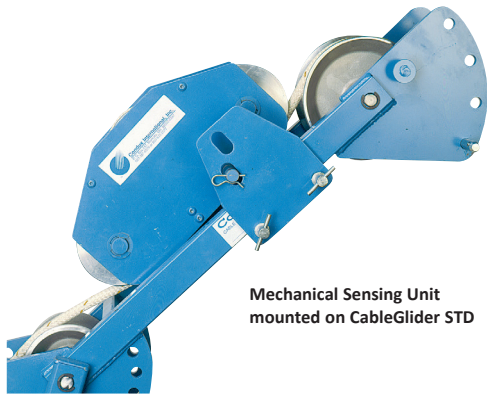

Mechanical Sensing Unit mounted on CableGlider STD



Running Line Tensiometer

The Condux Running Line Tensiometer, used with the Condux CableGlider® Cable Pullers will give accurate measurements of the force exerted on a cable as it is installed. It consists of two components: Mechanical Sensing Unit (which mounts directly to the cable puller) and the Electronic Control Box.

The unit will accommodate pull tape and rope up to and including 7/8" diameter with an accuracy of ±5% of full scale. Load handling capabilities and other specifications are determined by the model used.

Mechanical Sensing Unit

Mounts easily to the cable puller frame with a mounting bracket and pin. The Condux Running Line Tensiometer's Mechanical Sensing Unit permits rope installation without disassembly of the unit.

Electronic Control Box

Features large LED Display and Paperless Recorder with trend display. Paperless Recorder includes: Trend Display, CompactFlash™ card slot with 64MB Flash Card, and USB interface. A programmable overload set point has both an audible and visual indication of an overload condition. The Electronic Control Box also has the capability to disengage the cable puller if an overload occurs.

Running Line Tensiometer, CableGlider STD

Measures loads of 0 to 6,500 lbs. (0 to 28,913 N) with an accuracy of ±325 lbs. (1,446 N).

Units comes standard with the following:

- Mechanical Sensing Unit
- ECB with these standard features:
 - o Large LED readout
 - o Paperless recorder with Trend Display, Compact Flash Drive™ with 64MB Flash Card
 - o USB Interface
- Load Cell and Cord
- Mounting Hardware
- Card Reader and Software

NOTE: For recalibrating, please call 1-800-533-2077, for RMA.

Part Number	Description
08677350	110 Volt RLT for CableGlider STD w/data recorder



CONDEX

RUNNING LINE TENSIDIOMETER

Running Line Tensiometer, CableGlider HD

Measures loads of 0 to 12,000 lbs. (0 to 53,379 N) with an accuracy of ±600 lbs. (2,669 N).

Units comes standard with the following:

- Mechanical Sensing Unit
- ECB with these standard features:
 - o Large LED readout
 - o Paperless recorder with Trend Display, Compact Flash Drive™ with 64MB Flash Card
 - o USB Interface
- Load Cell and Cord
- Mounting Hardware
- Card Reader and Software

NOTE: For recalibrating, please call 1-800-533-2077, for RMA.

Part Number	Description
08677360	110 Volt RLT for CableGlider HD w/chart recorder
08677365	110 Volt RLT for CableGlider HD w/chart recorder and nylatron rollers

Replacement Mechanical Sensing Units

Part Number	Description
08677373	Mechanical Sensing Unit for STD
08677374	Mechanical Sensing Unit for HD

Remote Mount Stand for Mechanical Sensing Unit

Required for use of the Running Line Tensiometer when the power pack is not mounted to the standard frame, such as when floor-mounted (pg. 75).

Part Number	Description
08677385	Remote Mount Stand for Mechanical Sensing Unit

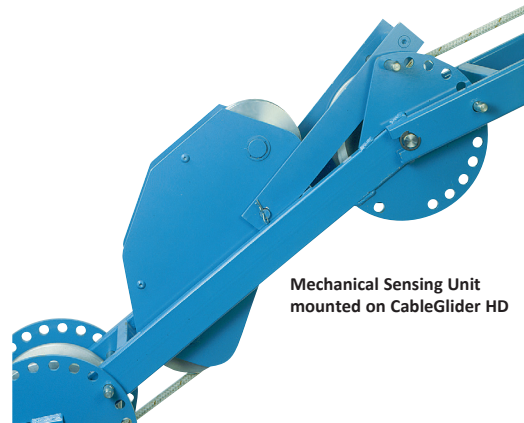
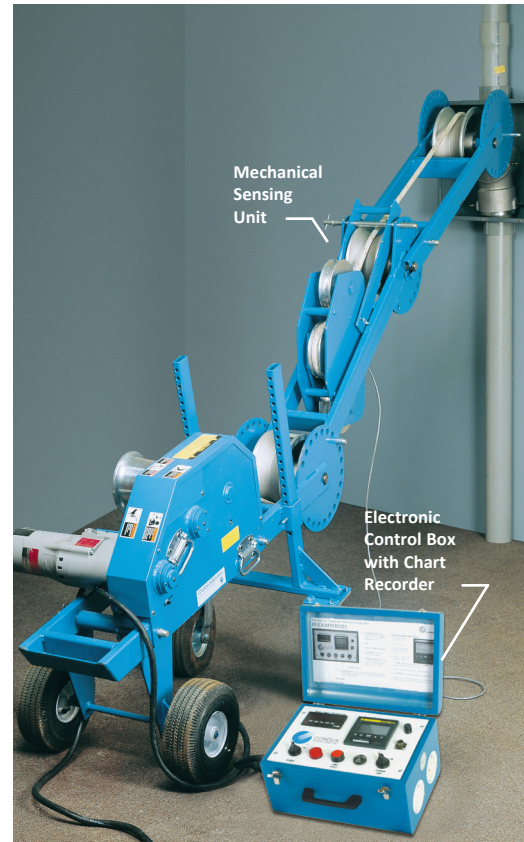

Running Line Tensiometer Electronic Control Box



Paperless Chart Recorder with Flash Drive and USB Interface



THE BLUE OX™ CABLE PULLER

POWER CABLE INSTALLATION

The Blue Ox™ Cable Puller

Combining years of experience, field research and end user feedback, The Condux Blue Ox™ Cable Puller has been designed to excel in the most demanding utility applications. Featuring 8,500 lbs of continuous pull force, a heavy duty steel frame and hydraulically controlled boom and outriggers, The Blue Ox does not require the arm to be supported during pulling operations. The extendable - up to 90" - steel boom arm boasts 150° of lateral adjustment, providing easy access in even the most confined areas.

Part Number	Description
08773001	The Blue Ox Cable Puller without Compressor
08775500	The Blue Ox Cable Puller with Compressor

NYLATRON* ROLLERS have a super-hard surface and last longer than conventional cast rollers.

*Nylatron is a registered trademark of DSM.

HEAVY DUTY Outriggers for maximum stability

SELF SUPPORTED BOOM ARM 150° lateral movement and 85° vertical movement.

ANTI-TWIST ROPE 3,000' of 3/8" rope comes standard with The Blue Ox.

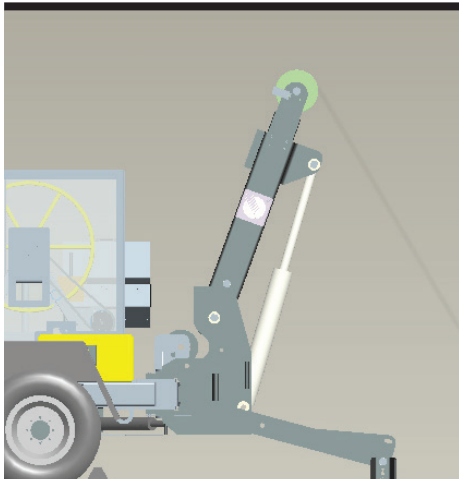

The Boom Arm features the ability to pull 85° from the manhole; eliminating the need for an A-Frame.

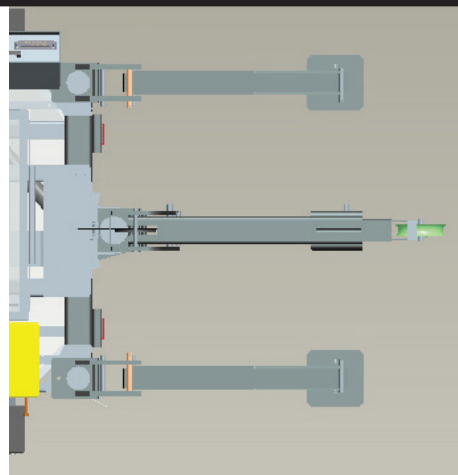

Outriggers allow The Blue Ox to pull directly over the hydraulics without being hooked to a tractor or a truck.



THE BLUE OX™ CABLE PULLER



POWER CABLE ISNTALLATION

OIL COOLER Hydraulic puller units with oil cooler provide a smooth operation throughout the pull.

TOOL BOX Fully enclosed unit to store any necessary tools for the jobsite.

ELECTRONIC BRAKING SYSTEM with a 7 pin round connector

TOOL CIRCUIT for running additional hydraulic tools.

HYDRAULIC JACKS are easy to use and improve set up time.

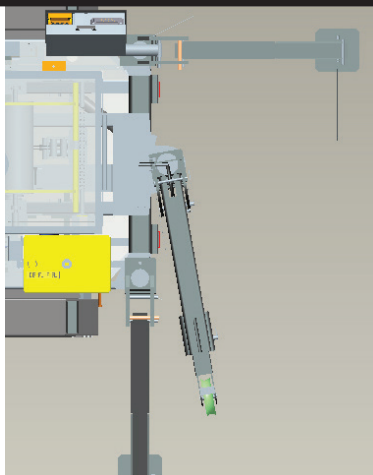

The combination of the outrigger and the boom arm allows for easy pulling 75° from the right or left of center

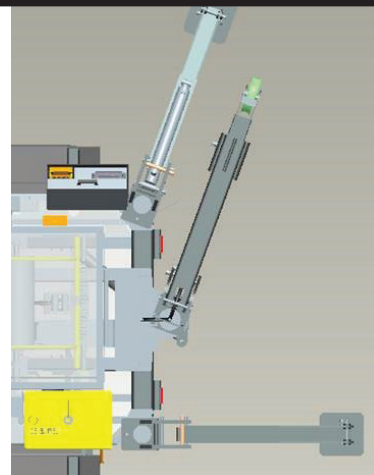



THE BLUE OX™ CABLE PULLER

POWER CABLE INSTALLATION



7" COLOR DISPLAY
gives all of the information
you need during the pull



WIRELESS REMOTE
with 50' range provides
flexibility for the installer.

Control Box

- Real Time Tension Monitoring
- Downloadable Pull Data
- Wireless/Bluetooth Remote Control

Replacement Rope

Part Number	Description
08771275	3/8" x 2450' Antitwist Rope with woven eye
08773112	3/8" x 3000' Antitwist Rope with woven eye
08773189	3/8" x 2600' IWRC 6x25 Rope with eye
08773190	3/8" x 3000' IWRC 6x25 Rope with eye
08773196	3/8" x 3600' IWRC 6x25 Rope with eye

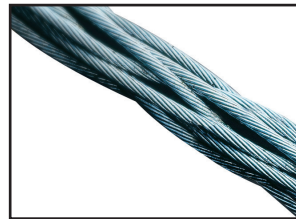

Antitwist Rope

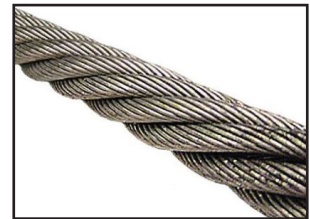

IWRC Rope

Replacement Parts

Part Number	Description
02291362	Hitch Pin (Outrigger - up/down)
08772016	Clevis Pin with Cotter Pin (Outrigger - left/right)
08772017	Clevis Pin with Cotter Pin (Boom Arm)
08773084	Clevis Pin with Cotter Pin (Foot pin)
08773317	Levelwind Brass Pawl
08773020	Remote and Receiver Kit
02292756	Replacement Remote Only (requires original black chip)
08773110	18gal Fuel Tank Upgrade Kit (to aluminum tank)

For a list of replacement filters, visit condux.com



THE BLUE OX™ CABLE PULLER



POWER CABLE ISNTALLATION

THE BLUE OX™ CABLE PULLER SPECIFICATIONS		
	Standard	w/Compressor
Performance		
Maximum Line Pull (lbs)	8,500	
Maximum Speed (fpm)	175	
Engine		
Engine Type	Diesel	
Horsepower	49	74
Electrical System	12 volt	
Fuel Tank (g)	18	22
Bullwheel		
Dimensions	8 inch diameter with 7 grooves	
Rope Reel w/Built in Level Wind		
Antitwist Rope	3000 feet of 3/8 inch	
Hydraulics		
Tool Circuit	7 gpm @ 2000 psi	
Dimensions		
Width	95 inches	
Height	108 inches	
Length	192 inches	
Weight	9,000 Pounds (Wet)	10,500 Pounds (Wet)
Axle	Single	
Air Compressor		
Velocity	210 cfm @ 125 psi	
Compressor Hose with Couplings	3/4" x 50' air hose reel	





APS75 CABLE PULLER

POWER CABLE INSTALLATION

APS75 Cable Puller

The Condux APS75 Hydraulic Underground Cable Puller provides up to 7,500 lbs of continuous pulling power to tackle some of the toughest pulling applications.

Designed for installing underground cable, the APS75 is completely self-contained and transports easily from jobsite to jobsite. Features like antitwist rope, digital monitoring, a rotating pulling arm and wired remote control make the APS75 an economical choice to meet a wide array of underground cable pulling needs.

The APS75 is precision manufactured to the highest standards. Each puller is backed with years of underground cable pulling experience and a commitment to quality customer service.

Part Number	Description
08773501	APS75 w/Hydraulic Arm & Jacks
08773502	APS75 w/Compressor & Hydraulic Arm & Jacks

Air Compressor Unit



The APS75 is available with a 185 CFM @ 100 PSI air compressor. The air compressor unit comes with the same standard features as the non-compressor unit.

NYLATRON* ROLLERS

have a super-hard surface and last longer than conventional cast rollers.

*Nylatron is a registered trademark of DSM.

STRAIGHTFORWARD OPERATOR CONTROLS allow equipment operator to safely operate the puller with a very short training period.

PULL TENSION MONITORING integrated into the puller including adjustable limit to control pull limits to manufacturer specs.

ROTATING ARM pivots 30° in either direction aligning easily and accurately.

CONTROLLED PAY-IN AND PAY-OUT offers more operator control and safety.

DOT CERTIFIED TRAILER

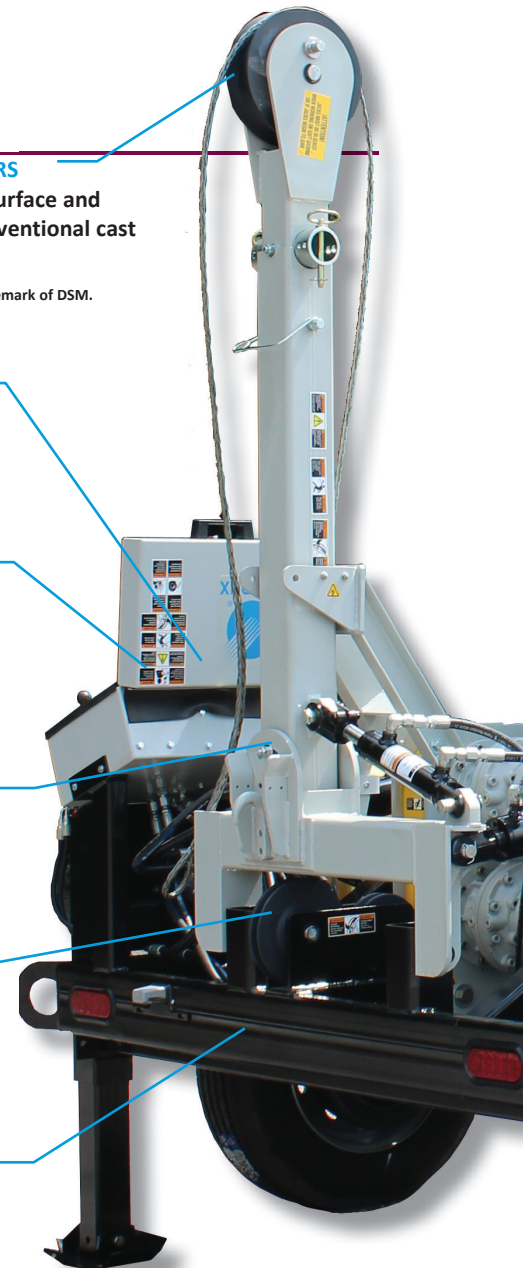

HYDRAULIC TOOL CIRCUIT

Each unit comes standard with a hydraulic tool circuit to operate additional hydraulic powered tools. The fully enclosed sound attenuated hydraulic power pack offers 40 gpm pump & motor with a 20 gallon filtered reservoir. Seven gpm @ 2000 psi is available for hand tools and pumps.

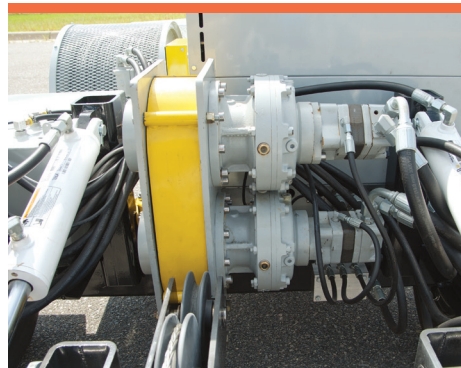

THE BRANDS YOU KNOW

Major engine, hydraulic system and trailer components are from widely popular national suppliers meaning excellent reliability and spare parts availability.



STABILITY

The APS75 is designed with a low center of gravity, excellent front/rear weight distribution, and numerous adjustable supports for optimum stability for both the road and the job.



APS75 CABLE PULLER

TIER4 Final DIESEL ENGINE provides 49 HP and features easy access maintenance. Water cooled.

USB PORT
Standard USB connection allows users to record and download pulling operations onto a flash drive. Information is downloaded as a .csv file and can be copied onto any computer, then printed, saved and/or emailed.



HYDRAULIC JACKS
Hydraulically powered jack stands are easy to use and improve set up time.

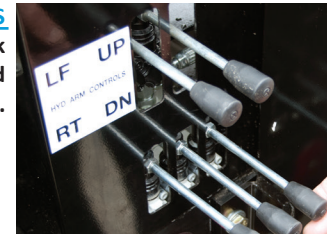

FULLY ENCLOSED UNIT
The APS75 is safe, convenient and reliable.

ON BOARD TOOLBOX
is also fully enclosed.

ELECTRIC BRAKES with a 7 pin round connector standard.

HYDRAULIC PULLER UNITS WITH OIL COOLER provide smooth operation throughout the pull.

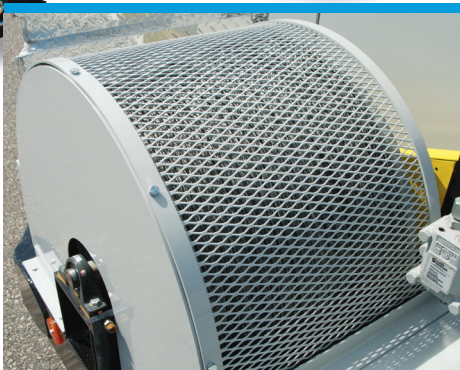

SAFETY

All moving parts are housed safely in enclosures or protected by guards to help improve operator and jobsite safety. The trailer unit also comes standard with electric brakes.



ANTITWIST ROPE WITH LEVEL WIND

Comes standard with 2450 ft. of antitwist rope and built-in reel winder with automatic level wind. Advantages include high flexibility, absolute minimal cable twisting and equal distribution of tension among primary wires. Results in increased pulling efficiency, less duct abrasion and can be spliced in the field.



EASY TO OPERATE

The APS75 features an easy-to-read control panel that includes a convenient hard-wired remote that helps improve safety by allowing the operator to monitor the manhole while distancing himself from noise and moving components.



APS75 CABLE PULLER

POWER CABLE INSTALLATION



Electronic Information Center

A digital readout allows the operator to view pulling forces, distance pulled, tension limiter and hydraulic pressure readings. Tension limits are setup quickly and easily. The APS75 also comes standard with a wired remote control to provide the operator added safety and convenience. Emergency stop buttons located on the main panel and remote control will stop the pull operations immediately when pressed. Pulling operations can be recorded and downloaded after the pull through a convenient USB port located on the display.

- Control lever for pull in, neutral and payout
- Digital tension readout with set point and automatic control of maximum pull with load cut-off.
- Digital footage counter that reads the footage of pulling rope paying in or paying out.
- Warning lights

Other Standard Features:

- Easy to operate control panel
- DOT Certified Trailer
- Electric Brakes with a 7 pin connector standard
- Tension readout integrated in the puller to control pull limits.



APS75 SPECIFICATIONS		
	Standard	w/Compressor
Performance		
Maximum Line Pull (lbs)	7500	
Maximum Speed (fpm)	175	
Engine		
Engine Type	Diesel	
Horsepower	49	
Electrical System	12 volt	
Fuel Tank (g)	18	
Bullwheel		
Dimensions	8.4 inch dia with 6 grooves	
Rope Reel w/Built in Level Wind		
Antitwist Rope	2450 feet of 3/8 inch	
Hydraulics		
Tool Circuit	7 gpm @ 2000 psi	
Dimensions		
Width	94 inches	
Height	104 inches	
Length	176 inches	225 inches
Weight	6,100 Pounds (Wet)	8,000 Pounds (Wet)
Air Compressor		
Velocity		185 cfm @ 100 psi
Compressor Hose with Couplings		3/4" x 50' air hose reel



APS75 CABLE PULLER



Aluminum A-Frame

The APS75 A-frame extension adds productivity by adjusting quickly to difficult pulling situations. Added reach for pulling extra slack is ideal for manhole applications and challenging job site conditions.

Part Number	Description
08771350	Aluminum A-frame APS75



POWER CABLE ISNTALLATION

Replacement Rope

Part Number	Description	Break Strength
08771275	3/8" x 2450' Antitwist Rope with woven eye	16,800 lbs.
08773189	3/8" x 2600' IWRC 6x25 Rope with eye	15,100 lbs.

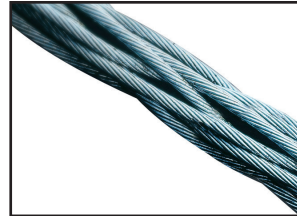

Antitwist Rope

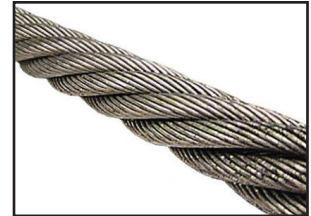

IWRC Rope

Replacement Parts

Part Number	Description
08771341	Boom Arm Transport Retainer Pin
02291018	Boom Arm Extension Lock Pin
08763155	Boom Jack (hand crank)
02289141	Hitch Pin for Boom Jack
08773317	Levelwind Brass Pawl
08773111	Fuel Tank Upgrade Kit (to aluminum tank)

For a list of replacement filters, visit condux.com





FLEXIBLE CABLE GUIDES



! **ORDER CAREFULLY!**
This item is made-to-order
and is not returnable.

Flexible Cable Guides with Aluminum Adapters

Cable feeds through the Bell Adapter and exits through the Duct Adapter which fits into the duct. Bell Adapter and Duct Adapter included for specific duct and guide size ordered.

Part Number	Diameter		Length	
	(IN.)	(MM)	(FT.)	(M)
08931009	2	51	9	2.7
08931012	2	51	12	3.6
08934009	4	102	9	2.7
08934012	4	102	12	3.6
08935009	5	127	9	2.7
08935012	5	127	12	3.6
08936009	6	152	9	2.7
08936012	6	152	12	3.6
08988009	8	203	9	2.7
08988012	8	203	12	3.6

Duct Adapters (includes mounting bolts)

Part Number	Diameter		Duct Size		OD		ID	
	(IN.)	(MM)	(IN.)	(MM)	(IN.)	MM	(IN.)	MM
08931010	2	51	1.00	25	0.90	23	0.72	18
08931013	2	51	1.25	32	1.22	31	1.00	25
08931015	2	51	1.50	38	1.44	37	1.19	30
08934020	4	102	2.00	51	1.91	49	1.65	42
08934030	4	102	3.00	76	2.94	75	2.69	68
08934035	4	102	3.50	89	3.44	80	3.13	87
08935020	5	127	2.00	51	1.98	50	1.75	44
08935030	5	127	3.00	76	2.98	76	2.76	70
08935035	5	127	3.50	89	3.45	88	3.25	83
08935040	5	127	4.00	102	3.93	100	3.30	95
08936040	6	152	4.00	102	3.93	100	3.50	89
08936050	6	152	5.00	127	4.94	125	4.63	118

Replacement Duct Adapters

08931020	2	51	2.00	51	1.91	49	1.66	42
08934040	4	102	4.00	102	3.94	100	3.69	94
08935050	5	127	5.00	127	4.93	125	4.50	114
08936060	6	152	6.00	152	5.94	151	5.50	143
08988080	8	203	8.00	203	7.94	202	7.62	194

Replacement Bell Adapters (includes mounting bolts)

Part Number	Size		ID	
	(IN.)	(MM)	(IN.)	(MM)
08931000	2	51	2.00	51
08934000	4	102	4.00	102
08935000	5	127	5.00	127
08936000	6	152	6.00	152
08988000	8	203	8.00	203

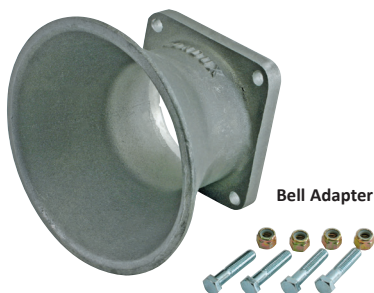
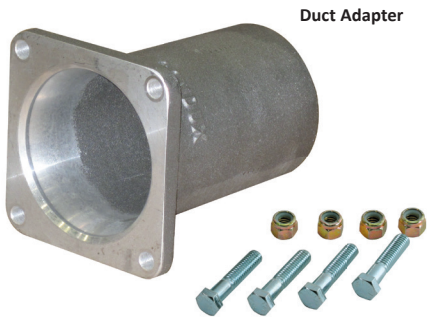

Extensions (includes mounting bolts)

Part Number	Diameter		Length	
	(IN.)	(MM)	(FT.)	(M)
08931503	2	51	3	.9
08931506	2	51	6	1.8
08931509	2	51	9	2.7
08931512	2	51	12	3.6
08934503	4	102	3	.9
08934506	4	102	6	1.8
08934509	4	102	9	2.7
08934512	4	102	12	3.6
08935503	5	127	3	.9
08935506	5	127	6	1.8
08935509	5	127	9	2.7
08935512	5	127	12	3.6

Part Number	Diameter		Length	
	(IN.)	(MM)	(FT.)	(M)
08936503	6	152	3	.9
08936506	6	152	6	1.8
08936509	6	152	9	2.7
08936512	6	152	12	3.6
08988503	8	203	3	.9
08988506	8	203	6	1.8
08988509	8	203	9	2.7
08988512	8	203	12	3.6

! ORDER CAREFULLY!
This item is made-to-order and is not returnable.

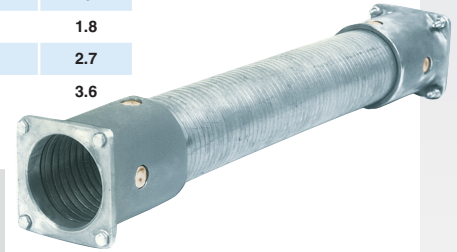

Cable Spreaders

4-6 inch Cable Spreaders attach to the Condux 4-6 inch Flex Guides to keep the cable separated as it goes into the flex guide. Comes standard with nylon rollers to help minimize friction and positive locking pins for attaching to the Flex Guide Bells.

Part Number	Description	Bell Size	
		(in)	(mm)
08041910	4-way Spreader, Cable Bell Adapter	4	102
08041915	4-way Spreader, Cable Bell Adapter	5	127
08041920	4-way Spreader, Cable Bell Adapter	6	152
08041930	3-way Spreader, Cable Bell Adapter	4	102
08041935	3-way Spreader, Cable Bell Adapter	5	127
08041940	3-way Spreader, Cable Bell Adapter	6	152



Lube Adapter Plates for Flex Guides

Lube adapter plates may be used at either the bell end or on the duct adapter end. Simply remove the bell or adapter end and insert lube adapter plate then use the supplied longer bolts to finish the lube adapter plate assembly.

Part Number	Description	Size	
		(in)	(mm)
08934075	Lube Adapter Plates for Flex Guides	4	102
08935075	Lube Adapter Plates for Flex Guides	5	127
08936075	Lube Adapter Plates for Flex Guides	6	152

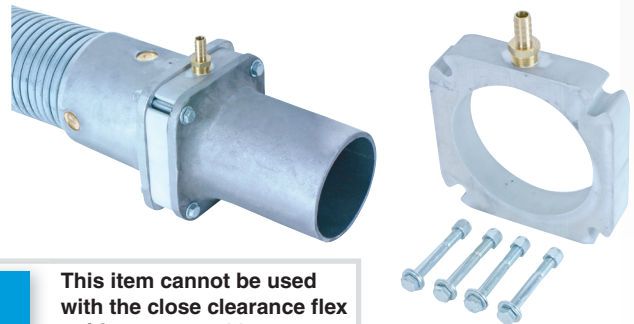

! This item cannot be used with the close clearance flex guides on page 90.

5 or 6 Gallon Lube Pump

Lube pump quickly attaches to the lube adapter plate. Comes with four feet of hose. (Longer lengths not available) Fits on either a 5 or 6 gallon pail.

Part Number	Description
08931100	5 or 6 Gallon Lube Pump





FLEXIBLE CABLE GUIDES



! ORDER CAREFULLY!
This item is made-to-order
and is not returnable.

Close Clearance Flexible Cable Guides

For guiding cable from the reel into the duct. The cable feeds through the Bell Adapter and exits through the Duct Adapter which fits into the duct. **Close Clearance Flexible Cable Guides require use of a Steel Duct Adapter, which must be ordered separately.**

Part Number	Diameter		Length	
	(IN.)	(MM)	(FT)	(M)
08040109	4	102	9	2.28
08041009	5	127	9	2.28
08044509	6	152	9	2.28

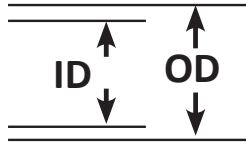
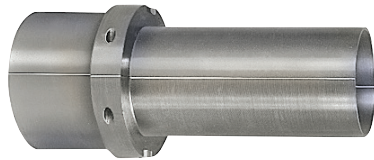

Steel Duct Adapter

Steel Duct Adapters (required for use of close clearance flex guides)

Part Number	Duct Adapter Diameter		Duct Size		OD		ID	
	(IN.)	(MM)	(IN.)	(MM)	(IN.)	MM	(IN.)	MM
08040300	4	102	3.00	76	2.93	74	2.68	68
08040400	4	102	3.25	83	3.06	74	2.81	71
08040600	4	102	3.50	89	3.43	87	3.18	81
08040800	4	102	4.00	102	3.81	97	3.62	92
08087200	4	102	5.00	127	4.81	122	4.63	118
08040900	5	127	4.00	102	3.87	98	3.69	94
08041300	5	127	5.00	127	4.81	122	4.62	117
08041200	5	127	6.00	152	5.81	148	4.62	117
08087000	6	152	5.00	127	4.81	122	4.62	117
08086800	6	152	6.00	152	5.81	148	5.62	143



Close Clearance Flex Guide Extensions

Part Number	Diameter		Length	
	(IN.)	(MM)	(FT)	(M)
08040203	4	102	3.5	1.1
08041103	5	127	3.5	1.1
08044603	6	152	3.5	1.1



JAMB SKID



Jamb Skid

The Condux Jamb Skid is a device for supporting sheaves or quadrant blocks inside a manhole to pull cable into underground conduit.

Constructed of solid aluminum, the Jamb Skid is both strong and lightweight. In most instances, it can be installed by one person. The complete unit is created by combining a base unit with one of several extension units, depending upon the height required. Locking 1 1/4" (32 mm) pins, allow the height adjustment of the Jamb Skid. Also, the width adjusts from 7" (178 mm) to 11" (279 mm) to accept all Condux sheave assemblies up to 8" (203 mm). 10,000 lbs. (44,480 N) cable tension load rated.

NOTE: Order base section, extension, and sheave separately for a complete Jamb Skid unit. Sheave pin and locking pins are included with the base section.

Part Number	Description	Manhole Height Range	
		(in)	(m)
08097000	58" (1.17 m) (Base Section)		
08097001	43" (1.09 m) Extension	63-80	1.24 - 2.03
08097002	76" (1.93 m) Extension	78-109	1.98 - 2.77
08097003	109" (2.8 m) Extension	107-138	2.72 - 3.51

Replacement Pins

Part Number	Description
08097040	1 1/4" (32 mm) diameter sheave pin
08097060	Locking Pin Kit (includes two locking pins)

Sheaves

Refer to the chart on page 97 for specifications on sheave products for use with the Condux Jamb Skid.

20,000 lbs. Jamb Skid

Constructed of steel and rated for 20,000 lbs (88,964 N) cable tension. Base section includes sheave pin and locking pins.

Part Number	Description
08097509	Base Section
08097532	43" (1.09 m) Extension
08097529	76" (1.93 m) Extension
08097508	109" (2.8 m) Extension

Sheaves for 20,000 lbs. Jamb Skid

Part Number	Sheave Size
08097502	5 x 26.5 in (127 x 673 mm)
08097504	8 x 11 in (203 x 279 mm)

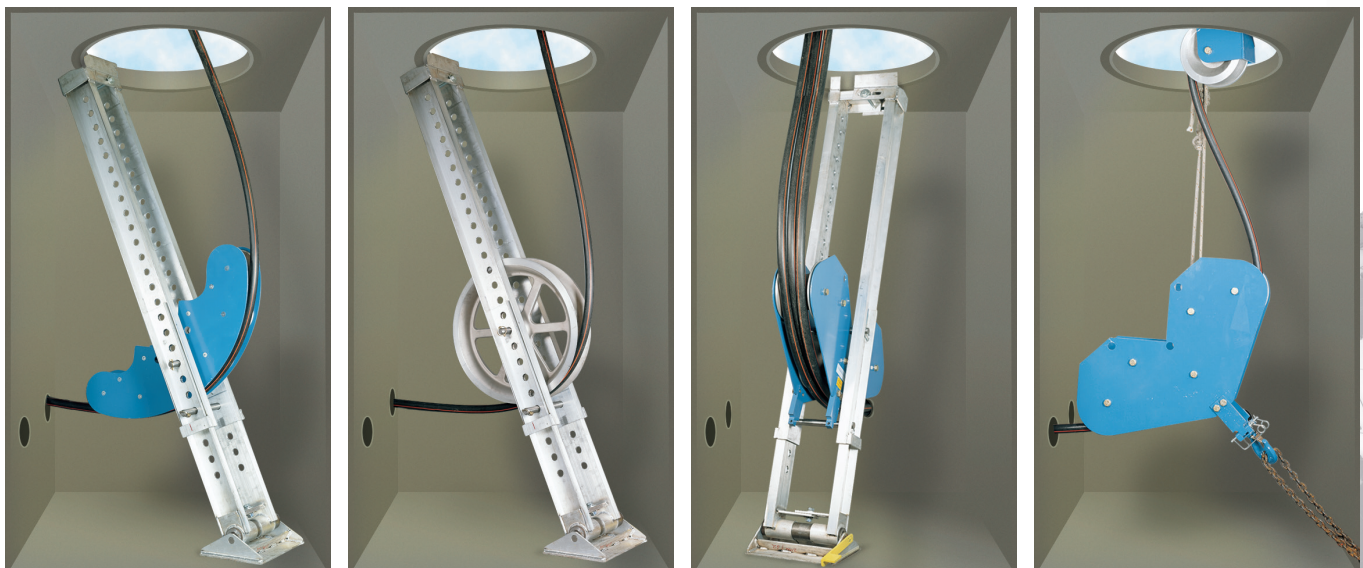
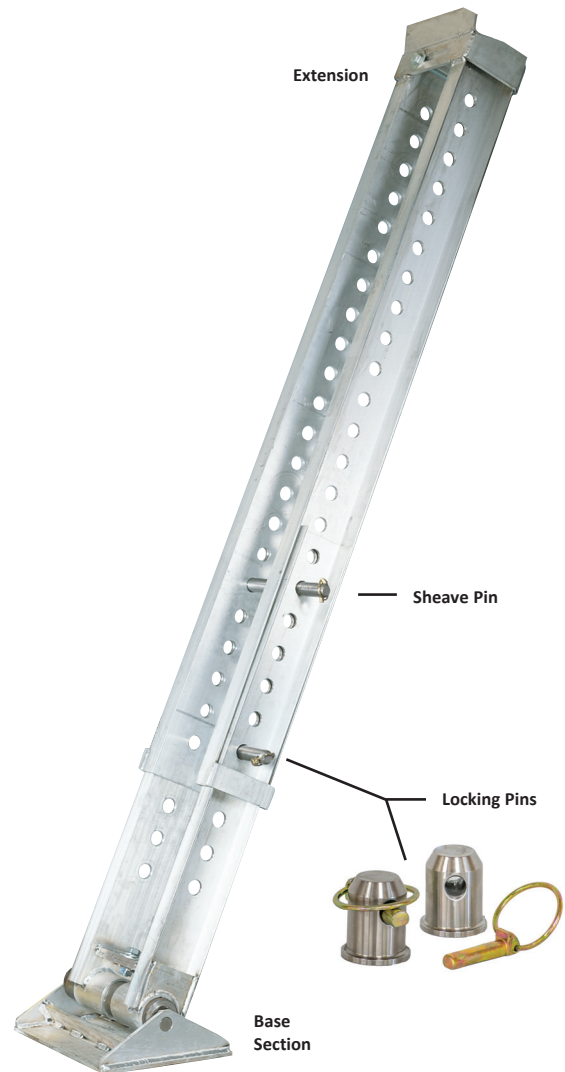



CABLE GUIDES

POWER CABLE INSTALLATION



Heavy Duty Hanger Sheaves

Tie off in the manhole to guide cable into the duct. 12,000 lbs. (53,378 N) cable tension load capacity. Includes light duty arm which conveniently stores inside the heavy duty arm when not in use. Also may be used with alignment arm for cable removal (5" sheaves only). Alignment arm sold separately.

Part Number	Sheave Size	
	(in)	(mm)
08042800	5x11	127x279
08042810	5x20	127x508
08042820	5x26.5	127x673
08042830	6x11	152x279
08042840	8x11	203x279
08045901	Alignment Arm for 5" (127 mm) Sheave	

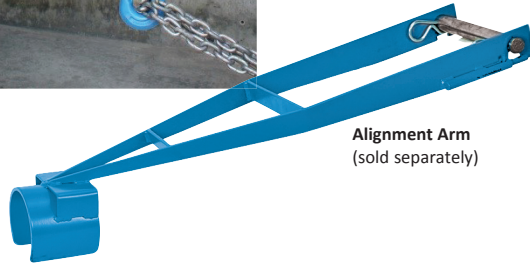

Alignment Arm
(sold separately)



Replacement Parts for Heavy Duty Hanger Sheaves



Hanger Arm w/Hook



Second Arm



Axle



Sheave

Sheave Size		Hanger Arm w/Hook Part Number	Second Arm Part Number	Axle Part Number	Sheave Part Number
(in)	(mm)				
5 x 11	127 x 279	08042801	08042809*	02291808	08042734
5 x 20	127 x 508	08042811	08042819*	02291808	08042735
5 x 26.5	127 x 673	08042811	08042819*	02291808	08042736
6 x 11	152 x 279	08042831	08042839*	02291808	08042737
8 x 11	203 x 279	08042841	08042849*	02291809	08042738

*1,000lb (4,448N) load rating

4,000 lb. Hooked Hanger Sheaves

Tie off in manhole to guide cable into and out of duct. 4,000 lbs (17,793 N) cable tension load capacity. For less demanding cable pulling applications than Condux heavy duty sheaves. Replacement sheaves available; see chart with specifications on page 97.

- Steel welded frame
- Nylon cable protectors
- Lightweight
- Cast aluminum sheaves
- Forged hook with 1.12" (28.45 mm) opening

Part Number	Sheave Size		Sheave Material
	(in)	(mm)	
08042611	5 x 11	127 x 279	Aluminum
08042610	5 x 11	127 x 279	Nylatron
08042620	5 x 20	127 x 508	Aluminum
08042626	5 x 26 ½	127 x 673	Aluminum
08042650	8 x 26	203 x 660	Aluminum

08042670 Second arm for 8"x26" (203 x 660 mm) sheave 1,000 lb (4448 N) rating for hanging only



4,000 lb. Hooked Hanger Sheaves

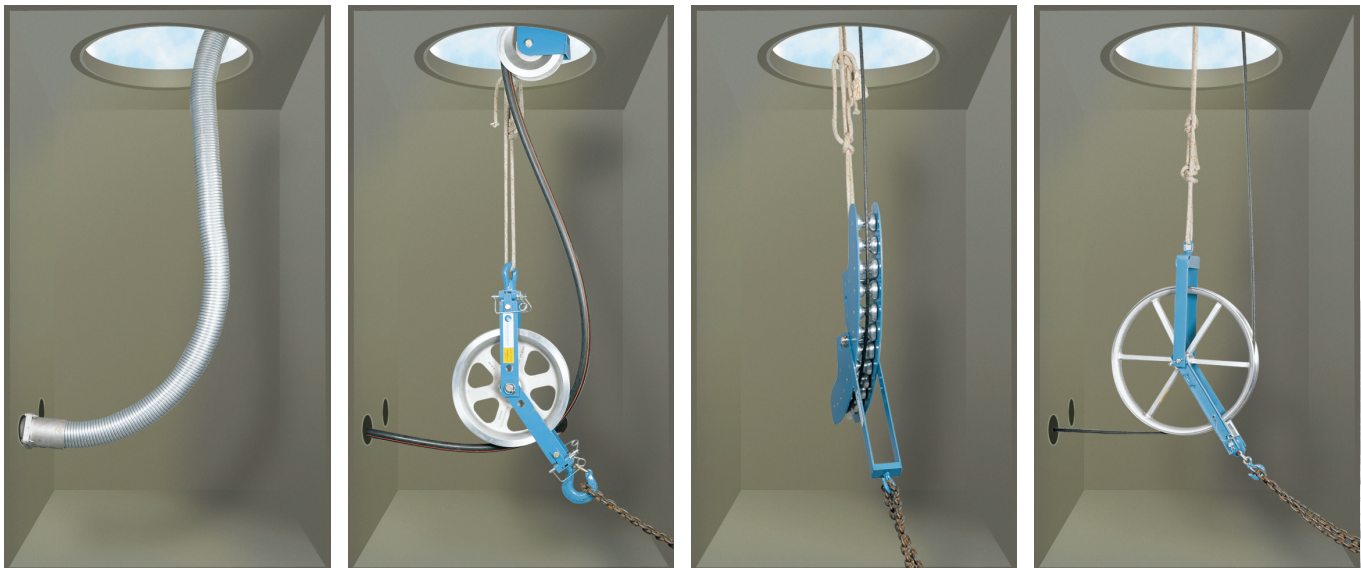



CABLE GUIDES

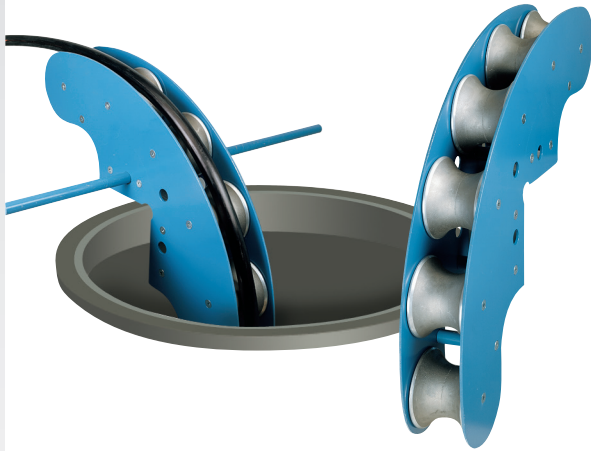

Heavy Duty Quadrant Block

A series of six cast aluminum or six Nylatron® sheaves on bronze bearings allow cable to make a gradual 90° turn for easy pulling through manhole opening. Can also be suspended in manhole to provide alignment to duct run. Support Bar sold separately (see pg. 96). Replacement Sheaves available. See Specifications and Selection Charts on page 97.

Part Number	Nylatron Part Number	Size		Radius		Load Capacity	
		(IN.)	(MM)	(IN.)	(MM)	(LBS)	(N)
08539100	08539110	4	102	24.25	616	4,800	21,351
08539200	08539210	5	127	24.25	616	4,800	21,351
	08539650	6	152	26.00	660	10,000	44,482
08539710	08539700	8	200	37.75	959	10,000	44,482



Hanger Arms

Allows the hanging of the HD Quadrant Blocks in a manhole for more flexible positioning.

Part Number	Used With
08042425	4" HD Quad Block
08539240	5" HD Quad Block
08539660	6" HD Quad Block
08082885	8" HD Quad Block

1.5" (38 mm) Cable Feeding Sheave

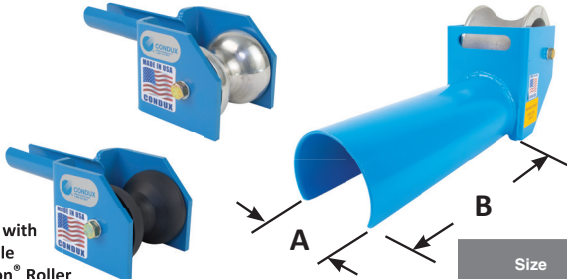

Shown with available Nylatron® Roller

Cable Feeding Sheaves

Plugs into conduit in manhole wall, guiding cable safely into the conduit regardless of the pulling angle. Sizes 3.5" and larger have a handle slot in the frame for easy carrying. Replacement Sheaves available. See Specifications and Selection Charts on page 97.

Part Number	Nylatron Part Number	Size		Tube Slot Width (A)		Tube Length (B)		Tube I.D.		Tube O.D.		Load Capacity	
		(IN.)	(MM)	(IN.)	(MM)	(IN.)	MM	(IN.)	MM	(IN.)	MM	(LBS)	(N)
08617312	-	1.25	32	0.88	22	5	127	1.06	27	1.19	30	1,000	4,448
08617215	08617415	1.50	38	1.04	26	5	127	1.26	32	1.44	37	1,500	6,672
08617220	08617420	2	51	1.38	35	6	152	1.69	43	1.88	48	2,600	11,565
08617225	08617425	2.50	63	1.44	37	8	203	2.14	54	2.38	60	2,600	11,565
08617230	08617430	3	76	2.24	57	12	305	2.63	67	2.87	73	4,800	21,351
08617270*	-	3	76	2.24	57	12	305	2.50	63	2.75	70	4,800	21,351
08617235	08617435	3.50	89	2.75	70	12	305	3.00	76	3.38	86	4,800	21,351
08617200	08617440	4	102	3.00	76	12	305	3.50	89	3.88	100	6,500	28,913
08617340*	08617441*	4	102	2.98	76	12	305	3.23	82	3.65	93	6,500	28,913
08617250	08617450	5	127	3.75	95	14	356	4.50	114	4.90	125	6,500	28,913
08617260	08617460	6	152	4.50	114	14	356	5.38	137	5.90	150	6,500	28,913
08617360*	08617461*	6	152	4.50	114	14	356	5.00	127	5.56	141	6,500	28,913
08617280	08617480	8	203	6.00	152	14	356	7.07	180	7.81	198	6,500	28,913

*Fits sch 80 pipe. NOTE: Nylatron® is a registered trademark of DSM



60 Degree Quad Block

A series of six Nylatron® sheaves allow cable to make a gradual 60° turn for easy pulling through manhole or pull box openings. Pulling radius of 24.25 inches (616 mm). 4,000 lbs. (17,792 N) cable tension load capacity. Support bar sold separately.

Part Number	Size	
	(in)	(mm)
08539220	8	203



Fairlead Quadrant Block

Originally designed to install transpacific fiber optic cable, these quadrant blocks provide a 60" (1,524 mm) pulling radius to guide any type of cable. 18 machined rollers 8" (203 mm) wide by 5.5" (140 mm) in diameter, allow the cable to make a gradual 90° turn for easy cable installation. 10,000 lb. (44,482 N) capacity. Replacement sheaves available, contact factory for information. **Item is not returnable.**

Part Number	Description	A		B		C	
		(in)	(mm)	(in)	(mm)	(in)	(mm)
08094500	Fairlead Quadrant Block w/ aluminum rollers	96	2438	36	914	9	229
08094510	Fairlead Quadrant Block w/ Nylatron rollers	96	2438	36	914	9	229

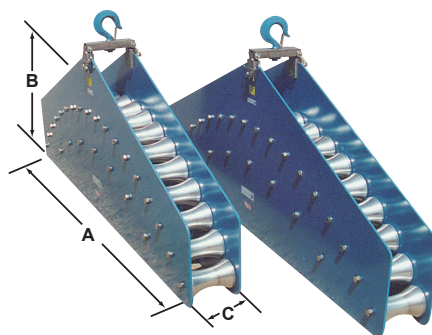

Three Sheave Cable Guide

Three cast aluminum or Nylatron® sheaves on bronze bearings allow a gradual 90° turn for easy pulling through manhole opening. Pulling radius of 24" (610 mm), the cable guide will sit on manhole edge, suspend in manhole, or fit the jamb skid. 10,000 lbs. (44,482 N) cable tension load capacity. Support bar sold separately (see pg. 96). Replacement sheaves available; see Specifications and Selection Charts on page 97.

Part Number	Nylatron Part Number	Size	
		(IN.)	(MM)
08539600	08539610	6	152
08539800*	08539810*	8	203

*NOTE: To fit the jamb skid, the four bolts holding the hook must be removed.

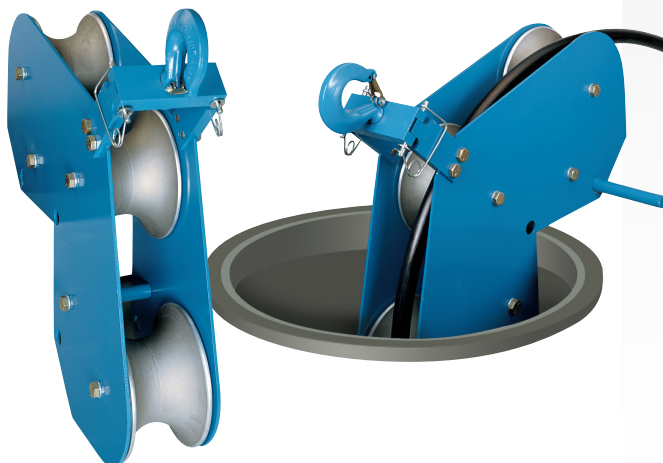

Mini Corner Cable Guide

Features two hardened steel rollers that guide steel winch line over sharp edges. It is small but sturdy, allowing for easy handling and set-up along with heavy duty capacities. 10,000 lbs. (44,482 N) cable tension load capacity. Replacement sheaves available, contact factory for information.

Part Number	Description
08045000	Mini Corner Cable Guide
08045010	Mini Corner Cable Guide w/o hook





CABLE GUIDES

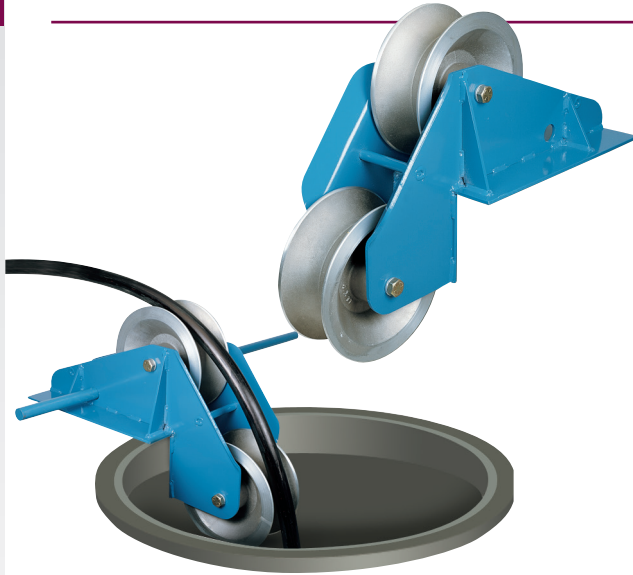

Corner Cable Guides

Aluminum and Nylatron® sheaves for pulling cable into manholes. 5,000 lbs. (22,241 N) cable tension load capacity. See Specifications and Selection Charts on page 97 for Replacement Sheaves. Support bar sold separately (see below).

Part Number	Nylatron Part Number	Size	
		(IN.)	(MM)
08043100	08043125	4	102
08043200	08043225	5	127
08088600	08088625	6	152
08088800	08088825	8	203

NOTE: Nylatron® is a registered trademark of DSM.



Cable Bending Shoe

Protects cable from corner abrasion during pulling operations. Bend radius of 20" (508 mm). Rugged, high-impact plastic.

Part Number	Description	ID		OD	
		(in)	(mm)	(in)	(mm)
08042100	Plastic Bending Shoe	3.19	81	3.44	87



Nylon Cable Protector

Flanged, split tube to insert in duct end and protect cable from damage during installation. Also can be left in place for permanent protection.

Part Number	Description
08042301	1"-2½" (25-63 mm) Duct
08042300	3"-6" (76-152 mm) Duct



Support Bar

Use to support quadrant blocks or cable guides at street level.

Part Number	Description
08091440	1½" (32 mm) x 4' (1.2 m) Steel Bar



Chains

Used to tie off cable guides in the manhole. Not to be used for overhead lifting.

Part Number	Description
08066301	4' (1.2 m) Chain, Double Hook, 3/8" (9 mm) Alloy Links, 7,100 lbs. (31,581 N) capacity
08066300	8' (2.4 m) Chain, Double Hook, 3/8" (9 mm) Alloy Links, 7,100 lbs. (31,581 N) capacity

Aluminum Split Bells

Plugs into conduit in manhole wall, guiding cable safely into the conduit regardless of the pulling angle.

Part Number	Size		Tube Length		Tube I.D.		Tube O.D.	
	(IN.)	(MM)	(IN.)	(MM)	(IN.)	(MM)	(IN.)	(MM)
08041520	2	51	8	203	1.625	41	1.875	48
08041530	3	76	8	203	2.625	67	2.875	73
08041535	3.5	89	8	203	3.125	79	3.375	88
08041540	4	102	8	203	3.625	92	3.875	98
08041550	5	127	8	203	4.625	117	4.875	124
08041560	6	152	8	203	5.625	143	5.875	149
08041564	6	152	12	305	5.625	143	5.875	149
08041570	8	203	12	305	7.500	191	7.875	200



Replacement Sheaves

Refer to this chart for specifications on sheave sizes for these products: 4,000 lb. (17,793 N) Hooked Hanger Sheaves, Cable Feeding Sheaves, Corner Cable Guides, Heavy Duty Quadrant Blocks, Three Sheave Cable Guides, and Jamb Skid.

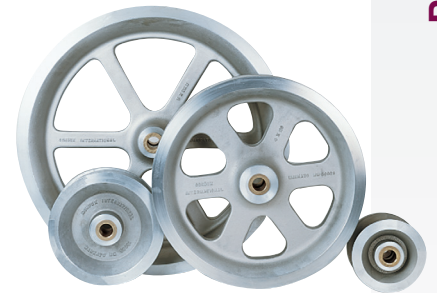
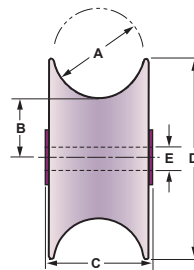

Sheaves Specifications

Part Number	Nylatron Part Number	Sheave Size		Maximum Cable O.D. (A)		Min. Bending Radius (B)		Max. Sheave Width (C)		Maximum Sheave O.D. (D)		Shaft Diameter (E)	
		(IN.)	(MM)	(IN.)	(MM)	(IN.)	(MM)	(IN.)	(MM)	(IN.)	(MM)	(IN.)	(MM)
08539308	08539304	1 x 3	25 x 76	1.50	38	0.75	19	3.19	81	3.00	76	0.63	16
08539136	08539137	4 x 7	102 x 178	4.00	102	2.25	57	4.35	110	7.00	178	1.25	32
08539236	08539237	5 x 7	127 x 178	5.00	127	2.25	57	4.93	125	7.00	178	1.25	32
08046711	08046712	4 x 11	102 x 279	4.00	102	3.75	95	4.94	125	11.00	279	1.25	32
08046811	08046812	5 x 11	127 x 279	5.00	127	3.25	83	5.94	151	11.00	279	1.25	32
08087811	08087812	6 x 11	152 x 279	6.00	152	3.13	79	6.94	176	11.00	279	1.25	32
08087911	08087912	8 x 11	203 x 279	8.25	210	2.75	70	8.94	227	11.00	279	1.25	32
08065411	-	4 x 20	102 x 508	4.25	108	8.50	216	4.94	125	20.00	508	1.25	32
08042911	-	5 x 20	127 x 508	5.00	127	8.00	203	5.94	151	20.00	508	1.25	32
08043011	-	5 x 26.5	127 x 673	5.00	127	11.31	287	5.94	151	26.50	673	1.25	32

4,000 lb Sheaves

Part Number	Nylatron Part Number	Sheave Size		Maximum Cable O.D. (A)		Min. Bending Radius (B)		Max. Sheave Width (C)		Maximum Sheave O.D. (D)		Shaft Diameter (E)	
		(IN.)	(MM)	(IN.)	(MM)	(IN.)	(MM)	(IN.)	(MM)	(IN.)	(MM)	(IN.)	(MM)
08042612	08046812	5 x 11	127 x 279	5.00	127	3.25	83	5.94	151	11.00	279	1.25	32
08042621	-	5 x 20	127 x 508	5.00	127	8.00	203	5.94	151	20.00	508	1.25	32
08042627	-	5 x 26.5	127 x 673	5.00	127	11.31	287	5.94	151	26.50	673	1.25	32
08042651	-	8 x 26	203 x 660	8.00	203	11.25	286	8.94	227	26.00	660	1.25	32

NOTE: Nylatron® is a registered trademark of DSM.

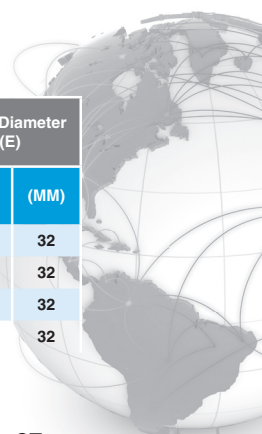



FIBER OPTIC CABLE BLOWING METHOD



An Efficient Method

Fiber optic cable blowing is one of the most efficient and safe means of installing fiber optic cable. A pressurized blowing system uses two forces to install fiber optic cable. A pulling force combines with a pushing force to cause the cable to travel through the duct like air. Today's fiber optic cable installations benefit from the pressurized blowing system because it provides greater installation speeds with less stress than traditional cable pulling.

The cable blower unit utilizes a hydraulic power system and an air compressor to generate the desired push and pull forces. Working together, this dual power supply provides greater blowing power with lower air consumption. Controls and gauges on the cable blower allow the operator to monitor the forces being exerted on the cable. The operator can make adjustments to make sure the forces being exerted on the cable are working with one another, not against one another.

Blowing minimizes the stress placed on cable during installation. Because the cable blower provides both pulling and pushing force, stress is more evenly distributed along the length of the cable.

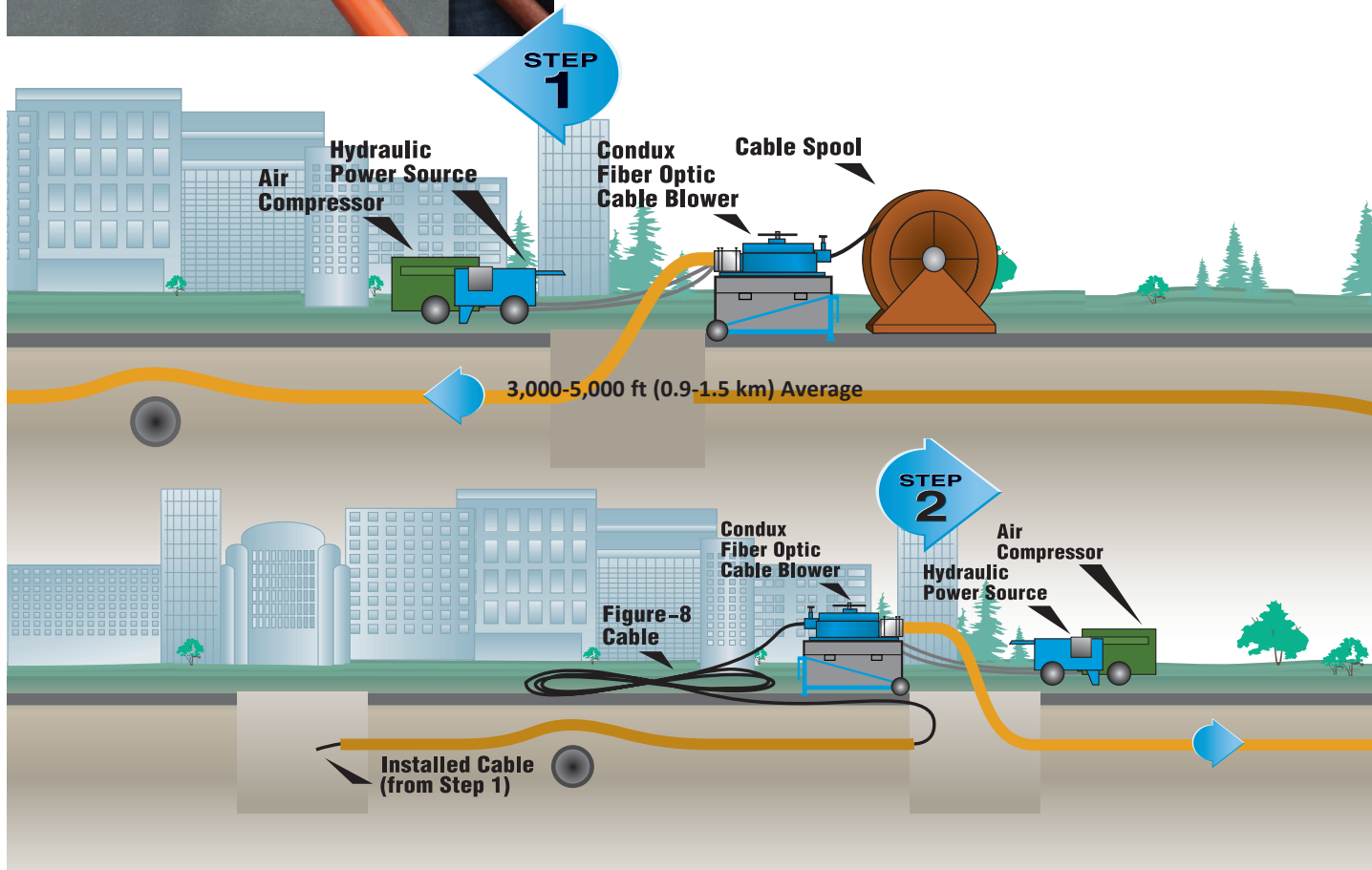



FIBER OPTIC CABLE BLOWING METHOD

Blowing vs. Pulling

Blowing cable is different from pulling cable in several ways. During cable pulling, the cable is kept taut and only pull force is applied. It travels in a straight line until a bend or curve changes its path. The cable ultimately rubs on each of the bends or curves, creating friction. As more pulling force is added to counteract the friction, additional stress is added to the cable.

Compared to a pulling application, blowing cable is faster and puts the cable under less stress.

Through cable blowing, contractors are able to install more cable per day with less manpower. This means increased productivity and decreased cost.

How To: The Typical Process

The typical cable blowing process consists of several steps. **First**, the duct integrity is checked. It is pressurized to check for leaks. In order to ensure a successful installation, the duct must be airtight and free of obstruction. Then a small amount of lubricant is poured in the duct and a foam carrier is blown through the run, confirming its integrity.

Second, the cable is prepared for installation. A cable carrier is attached to the end of the fiber optic cable. Corresponding size cable carriers are available to match the specific duct ID. The cable is fed through the cable blower and into the duct.

Third, the duct is lubricated. Lubricant is added in front of the cable carrier and behind the cable carrier.

Fourth, the blowing process begins. Pressure (compressed air) is applied to the duct behind the cable carrier. As the pressure tries to equalize, it seeks out the path of least resistance and creates a pushing force on the cable carrier, causing forward motion. The moving cable carrier, in turn, exerts a pulling force on the cable and begins to move it through the duct.

Meanwhile, an additional pushing force is applied to the cable by a hydraulic powered belt drive on the cable blower. Use of a hydraulic belt drive reduces air consumption requirements from the air compressor. Plus, the push force from the belt drive provides cable slack, reduces back tension and keeps the cable loose and flexible. Friction and resistance are then reduced and the cable can travel freely through the duct work.

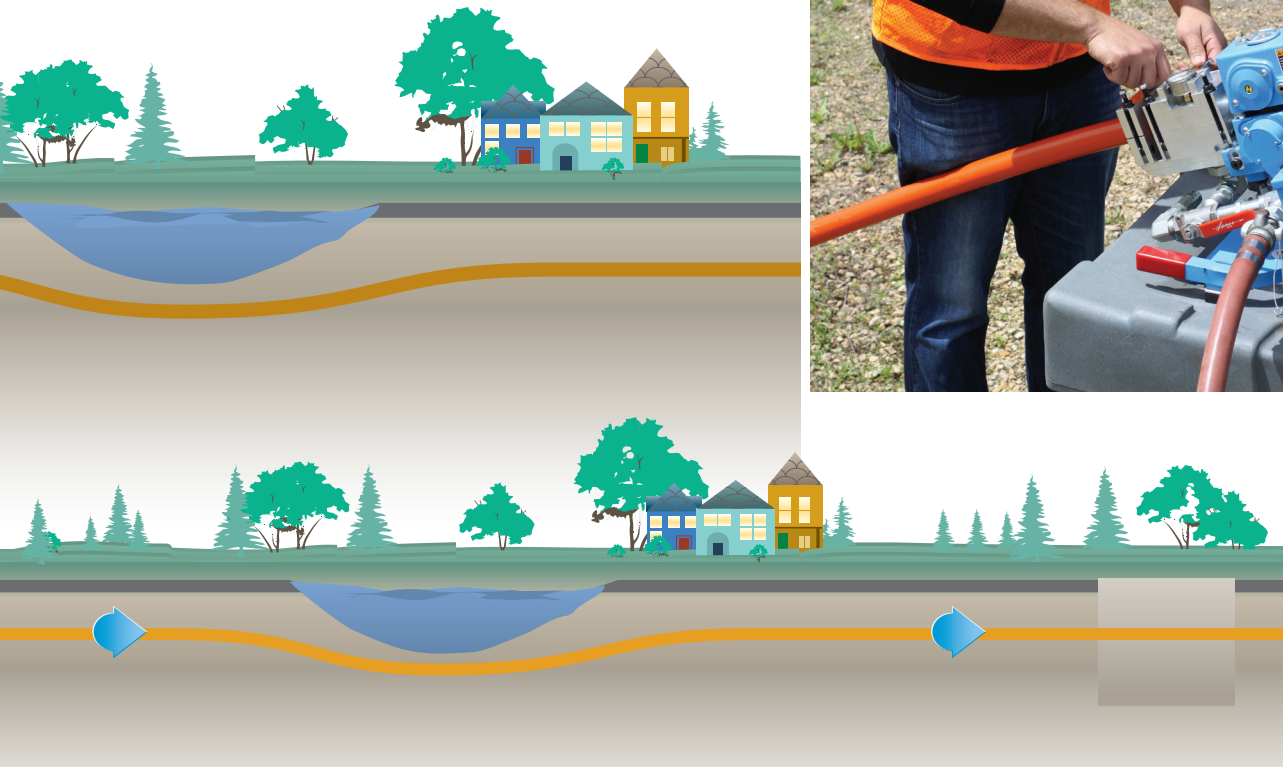



GULFSTREAM™ 400

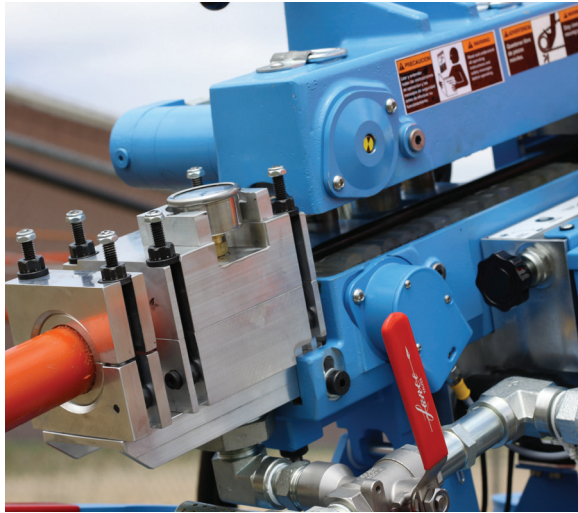

Gulfstream 400 Fiber Blower

The Condux Gulfstream™ 400 Fiber Optic Cable Blower is ideal for Fiber Installations

As a leader in the manufacture of cable installation tools and equipment, Condux offers a superior Fiber Optic Cable Blower that is compact and lightweight, making it ideally suited for your most difficult job sites.

Fast

Install fiber optic cable up to 300 fpm (100 mpm) (recommended 180-220 fpm (55-67 mpm)). A carrier can be attached to the front of the cable to help propel the fiber down an air-tight sealed duct. Because air flow and belt drive speed can be adjusted, you can install fiber at the rate which best suits your application.

Total Control

The Condux Gulfstream 400 Fiber Optic Cable Blower features a long belt grip area for less stress on the cable, and a manual cylinder on the belt feed to better control down pressure. Condux's patented traction control system shuts down the blower when problems with cable slippage or duct blockage are detected, adding safety to every job and preventing costly cable damage.

A speed and distance counter with LCD read-out, as well as convenient hydraulic and pneumatic controls, come standard with the Condux Fiber Optic Cable Blower. Blowers equipped with the Advanced Electronic Control System will shut down if slippage, over-speed or cable stoppage are detected.

Versatility

The Condux Gulfstream 400 Fiber Optic Cable Blower operates efficiently with most common combinations of cable and innerduct sizes. The Condux Gulfstream 400 Fiber Optic Cable Blower is designed for the installation of fiber optic cables with diameters from 0.23" (5.8 mm) to 1.13" (28.7 mm) into micro duct 10 mm to 18 mm and traditional innerduct ½" (13 mm) to 2" (51 mm) with metric sizes available.

The correct size cable seals and venturi must be determined for the cable being installed. Also necessary are the correct size innerduct seals, clamps and carrier for the innerduct being occupied.

Use the charts on page 104-105 to determine the correct size components for your specific cable and innerduct installation project.





GULFSTREAM™ 400



FIBER CABLE INSTALLATION

Superior Service & Support

The Condux Fiber Optic Cable Blower is precision manufactured in the USA by Condux International, Inc. Decades of technical experience and superior customer service are behind every product sold.

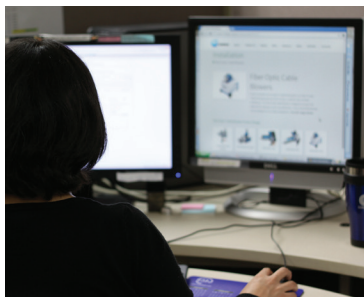

Smart Design, Easy to Operate

Convenient tilting of the Condux Gulfstream 400 Fiber Optic Cable Blower for ease of pouring in lubricant. Easily install cable into belt, then close and you are ready to start.

Hydraulic & pneumatic controls are ergonomically designed and conveniently located. No special maintenance is required.



Lightweight & Portable, Everything's Inside

The Condux Gulfstream 400 Fiber Optic Cable Blower is extremely easy to handle and transport. The blower and all accessories including hydraulic hoses, cable and conduit packs and seal kits conveniently fit into a lightweight job box with wheels.

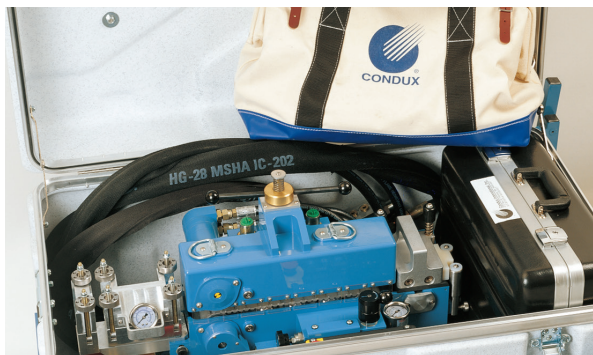



GULFSTREAM™ 400

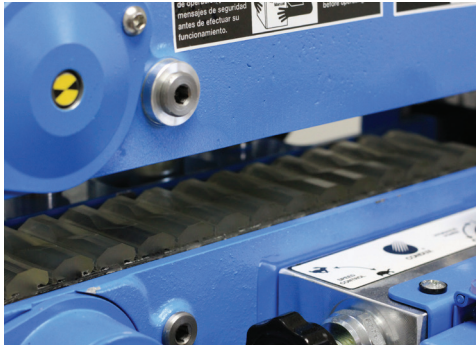

Belt Drive

Single belt drive provides for smooth and quiet operation. The belt can be easily removed and replaced making maintenance fast and simple.

Part Number	Description
08780904	Gulfstream 400 Replacement Belt



Advanced Electronic Controls

Standard system monitors and displays the cable and belt drive speeds. When using traction control it will automatically shut off the blower in these conditions:

- Over pressure limit
- Slippage
- Cable stoppage

Part Number	Description
08781020	Electronic Control Box
08781022	Electronic Control Box & Transducer Update
08781023	Transducer
02290843	ECB Fuse

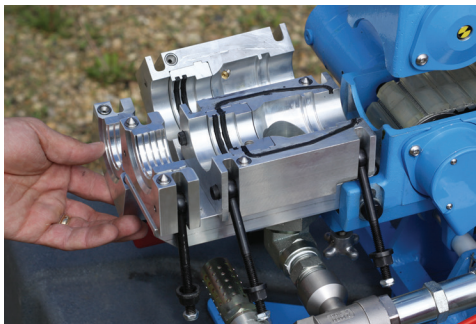

Hinged Air Block & Conduit Clamp

The Condux Fiber Optic Cable Blower features a hinged air block and a hinged conduit clamp that are easily secured and opened with the use of a ratchet.

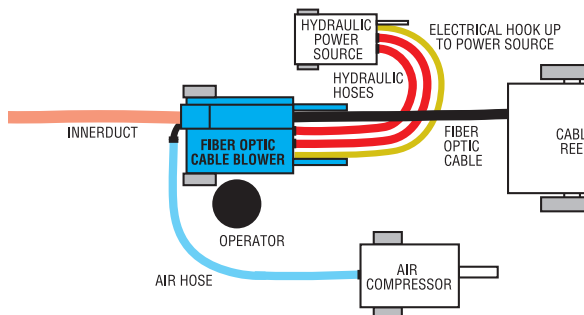

Dual Power System

Designed to operate with two power supplies that work in tandem in order to produce the most steady, efficient and reliable power to blow cable. A hydraulically-powered belt drive supplements the pressurized air force, thus decreasing the CFM requirements of the air compressor. This means greater cable blowing efficiency using a much smaller air compressor.

Part Number	Description
08780384	Hydraulic Hose with flow control manifold



CONDEX

The Condux Gulfstream™ 400 Fiber Optic Cable Blower is easy to order. The base unit comes complete with a job box, hydraulic hoses and everything listed below in the "Common Parts Kit." Complete the order by specifying the cable pack(s) and duct pack(s) necessary to meet your exact job requirements. See pages 104-105 for full descriptions. You may order additional cable and duct packs at any time.

Part Number	Description
08782000	Fiber Optic Cable Blower
08782000INTL	Fiber Optic Cable Blower w/ Int'l Fittings
08782010	Fiber Optic Cable Blower Package 1A (includes Cable Packs #1-7 and Duct Packs #2-5)
08782008	Fiber Optic Cable Blower Package 1B (includes Cable Packs #1-7 and Duct Packs #4, 5, 6)

Mechanical Version (No Electronic Control Box or Sensors)

Part Number	Description
08782004	Fiber Optic Cable Blower
08782004INTL	Fiber Optic Cable Blower w/Int'l Fittings
08782046	Fiber Optic Cable Blower Package 2A (includes Cable Packs #1-7 and Duct Packs #2-5)
08782048	Fiber Optic Cable Blower Package 2B (includes Cable Packs #1-7 and Duct Packs #4, 5, 6)
08782054	Fiber Optic Cable Blower Package 2C (includes Cable Packs #1-7 and Duct Packs #9, 10, 14)
08782056	Fiber Optic Cable Blower Package 2D (includes Cable Packs #1-7 and Duct Packs #14, 15, 17)

Select your Cable Pack(s): (minimum one required)

Cable Packs include Cable Grips (for end of cable), Pneumatic Venturies and Cable Seals. See page 105 for ordering information.

Part Number	Description
08780393	Cable Pack #1 — 0.23-0.34 in (5.8-8.8 mm)
08780394	Cable Pack #2 — 0.35-0.48 in (8.9-12.2 mm)
08780512	Cable Pack #3 — 0.49-0.60 in (12.4-15.2mm)
08780395	Cable Pack #4 — 0.61-0.73 in (15.3-18.5 mm)
08780513	Cable Pack #5 — 0.74-0.85 in (18.8-21.6mm)
08780396	Cable Pack #6 — 0.86-0.97 in (22.0-24.5 mm)
08780514	Cable Pack #7 — 0.98-1.13 in (24.9-28.7 mm)
08781117	Cable Pack #8 — 10.4 x 5.5 mm (Nylatron Venturi for flat fiber cables)
08781118	Cable Pack #9 — 15.2 x 6.7 mm (Nylatron Venturi for flat fiber cables)

Select your Duct Pack(s): (minimum one required)

Duct Packs include Cable Grip (for end of innerduct), Cable Carrier, Innerduct Clamps, Innerduct Seals, Innerduct Pulling Eye & Foam Carriers. See page 104 for ordering information.

Part Number	Description
08780795	Duct Pack #1 — .5" SDR 11/13.5
08780680	Duct Pack #2 — .75" (27 mm) SDR 11/13.5
08780386	Duct Pack #3 — 1" SDR 11/13.5
08780392	Duct Pack #4 — 1.25" SDR 11/13.5
08780397	Duct Pack #5 — 1.5" SDR 11/13.5
08780930	Duct Pack #6 — 2" SDR 11/13.5
08781120	Duct Pack #7 — 20 mm
08781153	Duct Pack #8 — 22 mm
08780240	Duct Pack #9 — 25 mm
08780385	Duct Pack #10 — 32 mm
08780387	Duct Pack #11 — 36 mm
08780388	Duct Pack #12 — 37 mm
08780389	Duct Pack #13 — 1.25" TRUE
08780390	Duct Pack #14 — 40 mm
08780391	Duct Pack #15 — 42 mm
08780545	Duct Pack #16 — 44 mm
08780575	Duct Pack #17 — 50 mm

GULFSTREAM™ 400



FIBER CABLE INSTALLATION

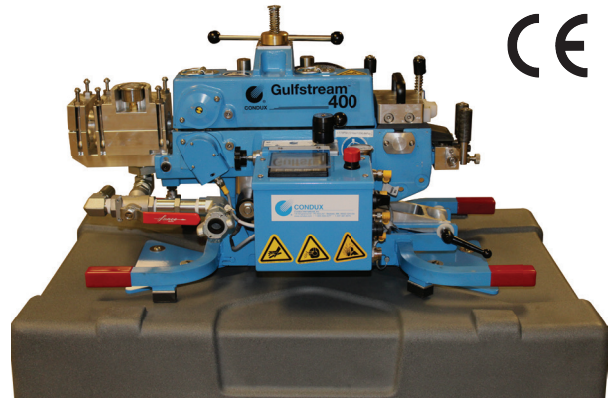

Common Parts Kit:

(included with all blower units)

Part Number	Description
08780120	Common Parts Kit (included with all ECB units)
08780952	Common Parts Kit (for Mechanical Version)

Kits include the following:

02290222	Small Case
08780506	Foam Insert for Small Case
02284600	Small Divided Case
02288774	Parts Label for Small Divided Case
08780126	O-Ring Seal Kit
02286416*	2 Pin Extension Cord
08230800	Canvas Bag
08017000	5/8" x 600 lb Swivel (16 mm x 2,669 N)
08780424	Capscrew Set (12-M04-07)
08761248*	Power Cord Assembly with Lighter Plug
02289620	Wrench, 3/4"
02290168	Standard & Metric Hex Key Set
02283800	Hex Ball Driver 3/32"
02288787	Hex Ball-Point Driver 2.5mm
02291090	9/16" Comb-Ratchet Wrench
08780223	Venturi Air Plug (Seal Disk)

*Not included in kit 08780952

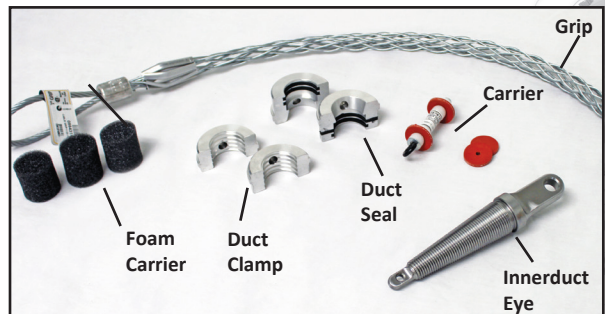
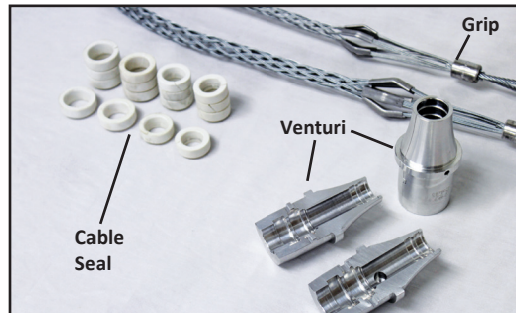



GULFSTREAM™ 400 DUCT PACKS

Gulfstream 400 & Mini-Blower Pusher Duct Packs

FIBER CABLE INSTALLATION

Pack	Duct Pack		Duct Clamp		Duct Seal		Carrier		Foam Carrier		Cable Grip		Innerduct Eye
	Duct Size	Part Number	Duct OD (mm)	Part Number	Duct OD (mm)	Part Number	Carrier OD (mm)	Part Number	Carrier OD (mm)	Part Number	Duct OD (mm)	Part Number	
1	1/2" SDR 11-13.5	08780795	0.840" (21.3)	08780791	0.840" (21.3)	08780786	0.688" (17.5)	08780793	0.75" (19.0)	08078300	0.75-0.99" (19-25)	08643131	08913342 .71-.77" (18-20)
2	3/4" SDR 11-13.5	08780680	1.050" (26.6)	08780682	1.050" (26.6)	08780685	0.750" (19.0)	08780690	0.75" (19.0)	08078300	1.00-1.24" (25.4-31.5)	08643137	08761840 .71-.87" (18-22)
3	1" SDR 11/13.5	08780386	1.315" (33.4)	08780369	1.315" (33.4)	08780307	1.121" (28.5)	08761250	1.25" (31.8)	08761439	1.25-1.49" (32-38)	08643143	08913343 .75-1.00" (19-25)
4	1.25" SDR 11/13.5	08780392	1.660" (42.2)	08780375	1.660" (42.2)	08780051	1.414" (35.9)	08761255	1.50" (38.1)	08761440	1.50-1.99" (38.1-50.5)	08643149	08761842 1.06-1.43" (27-36)
5	1.5" SDR 11/13.5	08780397	1.900" (48.3)	08780404	1.900" (48.3)	08780398	1.618" (41.1)	08761260	1.75" (44.5)	08761441	1.50-1.99" (38.1-50.5)	08643149	08761844 1.37-1.68" (35-43)
6	2" SDR 11/13.5	08780930	08780920 2" Duct Adapter				2.023" (51.4)	08761265	2.00" (50.8)	08761442	2.00-2.49" (50.8-63.2)	08643155	08761846 1.80-2.19" (46-56)
7	20mm	08781120	0.787" (20.0)	08781122	0.787" (20.0)	08781121	0.688" (17.5)	08780793	1.00" (25.4)	08761444	0.75-0.99" (19.0-25.1)	08643131	08914007 .551-.813" (14-20)
8	22mm	08781153	0.866" (22.0)	08781154	0.866" (22.0)	08781155	0.688" (17.5)	08780793	1.00" (25.4)	08761444	0.75-0.99" (19.0-25.1)	08643131	08914007 .551-.813" (14-20)
9	25mm	08780240	0.984" (25.0)	08780099	0.984" (25.0)	08780134	0.787" (20.0)	08780230	1.25" (31.8)	08761439	1.25-1.49" (31.8-37.8)	08643137	08761840 .71-.87" (18-22)
10	32mm	08780385	1.260" (32.0)	08780368	1.260" (32.0)	08780306	1.063" (27.0)	08761560	1.25" (31.8)	08761439	1.25-1.49" (31.8-37.8)	08643143	08761842 1.06-1.43" (27-37)
11	36mm	08780387	1.417" (36.0)	08780370	1.417" (36.0)	08780308	1.181" (30.0) 1.220" (31.0)	08761643 08761555	1.25" (31.8)	08761439	1.25-1.49" (31.8-37.8)	08643143	08761842 1.06-1.43" (27-37)
12	37mm	08780388	1.457" (37.0)	08780371	1.457" (37.0)	08780309	1.220" (31.0)	08761555	1.25" (31.8)	08761439	1.25-1.49" (31.8-37.8)	08643143	08761842 1.06-1.43" (27-37)
13	1.25" TRUE	08780389	1.500" (38.1)	08780372	1.500" (38.1)	08780333	1.250" (31.7)	08761670	1.50" (38.1)	08761440	1.25-1.49" (31.8-37.8)	08643143	08761842 1.06-1.43" (27-37)
14	40mm	08780390	1.575" (40.0)	08780373	1.575" (40.0)	08780334	1.299" (33.0)	08761525	1.50" (38.1)	08761440	1.50-1.99" (38.1-50.5)	08643149	08761842 1.06-1.43" (27-37)
15	42mm	08780391	1.653" (42.0)	08780374	1.653" (42.0)	08780335	1.378" (35.0)	08761660	1.50" (38.1)	08761440	1.50-1.99" (38.1-50.5)	08643149	08761844 1.37-1.68" (35-43)
16	44mm	08780545	1.732" (44.0)	08780546	1.732" (44.0)	08780547	1.496" (38.0)	08761786	1.50" (38.1)	08761440	1.50-1.99" (38.1-50.5)	08643149	08761844 1.37-1.68" (35-43)
17	50mm	08780575	1.969" (50.0)	08780435	1.969" (50.0)	08780431	1.606" (40.0)	08761579	2.00" (50.8)	08761442	1.50-1.99" (38.1-50.5)	08643149	08761844 1.37-1.68" (35-43)

Micro Duct Packs: Gulfstream™ 400 & Mini-Blower/Pusher

Duct Size OD (MM)	Part Number	Duct Clamp	Duct Seal	End Stop Connector
10	08764140	08764142	08764143	08566325
12	08764110	08764112	08764113	08566327
12.7	08764150	08764151	08764153	08566338
14	08764120	08764122	08764123	08566328
16	08764130	08764132	08764133	08566329
18	08781110	08781106	08781101	08566334





GULFSTREAM™ 400 CABLE PACKS



Gulfstream 400 Cable Packs

Pack	Cable Pack		Venturi		Cable Seal		Cable Grip	
	Cable OD	Part Number	Cable OD	Part Number	Cable OD	Part Number	Cable OD	Part Number
1	0.23" - 0.34" (5.8 - 8.8 mm)	08780393 Pack #1	0.23" - 0.34" (5.8 - 8.8 mm)	08780281	0.23" - 0.28" (5.8 - 7.2 mm)	08780406	0.21" - 0.35" (5.3 - 8.9 mm)	08643754
					0.29" - 0.34" (7.3 - 8.8 mm)	08780407		
2	0.35" - 0.48" (8.9 - 12.2 mm)	08780394 Pack #2	0.35" - 0.48" (8.9 - 12.2 mm)	08781115	0.35" - 0.42" (8.9 - 10.7 mm)	08761424	0.32" - 0.48" (8.1 - 12.2 mm)	08643755
					0.43" - 0.48" (10.8 - 12.2 mm)	08761425		
3	0.49" - 0.60" (12.3 - 15.2 mm)	08780512 Pack #3	0.49" - 0.60" (12.3 - 15.2 mm)	08781116	0.49" - 0.55" (12.3 - 14.0 mm)	08761426	0.42" - 0.61" (10.7 - 15.5 mm)	08643756
					0.56" - 0.60" (14.1 - 15.2 mm)	08761427		
4	0.61" - 0.73" (15.3 - 18.5 mm)	08780395 Pack #4	0.61" - 0.73" (15.3 - 18.5 mm)	08780284	0.61" - 0.67" (15.3 - 17.0 mm)	08761428	0.53" - 0.74" (13.5 - 18.8 mm)	08643757
					0.68" - 0.73" (17.1 - 18.5 mm)	08761429		
5	0.74" - 0.85" (18.6 - 21.6 mm)	08780513 Pack #5	0.74" - 0.85" (18.6 - 21.6 mm)	08780285	0.74" - 0.79" (18.6 - 20.1 mm)	08761430	0.64" - 0.87" (16.3 - 22.1 mm)	08643758
					0.80" - 0.85" (20.2 - 21.8 mm)	08761431		
6	0.86" - 0.97" (21.7 - 24.6 mm)	08780396 Pack #6	0.86" - 0.97" (21.7 - 24.6 mm)	08780286	0.86" - 0.92" (21.7 - 23.4 mm)	08761432	0.75" - 1.00" (19.1 - 25.4 mm)	08643759
					0.93" - 0.97" (23.5 - 24.6 mm)	08761433		
7	0.98" - 1.13" (24.7 - 28.7 mm)	08780514 Pack #7	0.98" - 1.13" (24.7 - 28.7 mm)	08780446	0.98" - 1.04" (24.7 - 26.4 mm)	08761434	1.00" - 1.24" (25.4 - 31.5 mm)	08643137
					1.05" - 1.13" (26.5 - 28.7 mm)	08761435		
8	10.4 x 5.5 mm	08781117	(Nylatron venturi for flat fiber cables)					
9	15.2 x 6.7 mm	08781118	(Nylatron venturi for flat fiber cables)					

FIBER CABLE INSTALLATION

Compressed Air Recommendations

For best installation results, we recommend a 375 CFM compressor or larger with at least 100 psi. A compressed air water separator and aftercooler are also highly recommended-- whether built-in to the compressor or as an additional unit in line between the compressor and fiber blower.





GULFSTREAM™ 400 MICRODUCT ACCESSORIES



Kit Includes:
 Pressure gauge
 Universal claw adapter

Micro Duct Pressure Gauge Kit

Use the Micro Duct Pressure Gauge Kit in conjunction with Air Valve Plugs for pressurizing Micro Duct to prevent kinking and crushing during installation. (Required and sold separately from Micro Duct Installation Kits)

Part Number	Description
08780705	Micro Duct Pressure Gauge
08780705INTL	Micro Duct Pressure Gauge, international



Multiple Micro Duct Installation Kits

Condux Multiple Micro Duct Installation Kits allow you to install up to 5 - 10/8 micro ducts, 4 - 12/10 micro ducts or other multiple micro duct configurations into an existing innerduct when used with the Condux Gulfstream™ 400 Fiber Optic Cable Blower. Microduct pressure gauge kit is required (sold separately).

Part Number	Description
08780710	10/8 mm Multiple Micro Duct Installation Kit
08780712	12/10 mm Multiple Micro Duct Installation Kit
08780770	12.7 mm Multiple Micro Duct Installation Kit
08780797	16 mm Multiple Micro Duct Installation Kit
08780878	14/10 mm Multiple Micro Duct Installation Kit
08780747	1-16 mm & 2-12/10 mm Multiple Micro Duct Installation Kit
08780723	Flat Belt for Flat Fiber

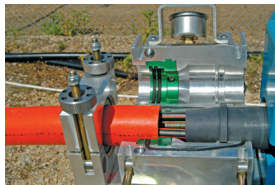

10/8 mm Kit (up to 5)	
Part Number	Description
08645705	Cable Grip
08780720	Lower Belt
08780721	Upper Belt
08780724	Rear Guide Assembly
08780735	5-Hole Venturi
08780739	Venturi Plugs
08780740	Duct-Fill Plugs
08780741	Duct-Cap Plugs
08780742	Rear Guide
08780748	Proofing Balls

12/10 mm Kit (up to 4)	
Part Number	Description
08645705	Cable Grip
08780722	Lower Belt
08780722	Upper Belt
08780724	Rear Guide Assembly
08780725	4-Hole Venturi
08780729	Venturi Plugs
08780730	Duct-Fill Plugs
08780731	Duct-Cap Plugs
08780732	Rear Guide
08780750	Proofing Balls

12.7 mm Kit (up to 4)	
Part Number	Description
08645705	Cable Grip
08780722	Lower Belt
08780722	Upper Belt
08780724	Rear Guide Assembly
08780732	Rear Guide
08780750	Proofing Balls
08780771	4-Hole Venturi
08780772	Venturi Plugs
08780774	Duct-Cap Plugs
08780776	Duct-Fill Plugs

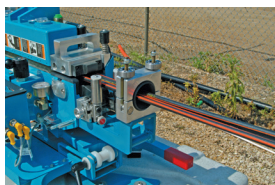

16 mm Kit (up to 2)	
Part Number	Description
08645710	Cable Grip
08783383	Proofing Balls
08780721	Upper Belt
08780723	Lower Belt
08780796	2-Hole Venturi
08780734	Rear Guide
08780743	Duct-Fill Plugs
08780745	Duct-Cap Plugs
08780724	Rear Guide Assembly

14/10 mm Kit (up to 3)	
Part Number	Description
08645710	Cable Grip
08783382	Proofing Balls
08780883	Upper Belt
08780882	Lower Belt
08780879	3-Hole Venturi
08780886	Rear Guide
08780730	Duct-Fill Plugs
08780731	Duct-Cap Plugs
08780724	Rear Guide Assembly

1-16 mm & 2-12/10 mm Kit	
Part Number	Description
08645710	Cable Grip
08017000	Swivel
08783383	Proofing Balls 16/13
08783382	Proofing Balls 12/10
08780733	3-Hole Venturi
08780734	Rear Guide
08780743	Duct-Fill Plugs 16/13
08780745	Duct-Cap Plugs 16/13
08780730	Duct-Fill Plugs 12/10
08780731	Duct-Cap Plugs 12/10
08780724	Rear Guide Assembly



GULFSTREAM™ 400 ACCESSORIES

Gulfstream™ 400 High Density Fiber Conversion Kit

With installation of the Gulfstream 400 High Density Fiber Conversion Kit on a Gulfstream 400 Fiber Blower, the blower is capable of installing large diameter ultra-high density OSP fiber into HDPE duct. The larger air block can accommodate 1" - 2" innerduct and fiber cable ranging from 0.49" to 1.54" (12.4 to 39.1 mm).

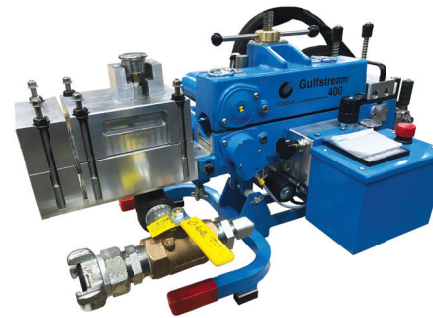

Conversion Kit

Part Number	Description
08782625	Gulfstream 400 High Density Fiber Conversion Kit

Duct Packs (minimum of one required)

Part Number	Description	
08761370	Duck Pack - 1"	SDR 11/13.5
08761375	Duck Pack - 1.25"	SDR 11/13.5
08761380	Duck Pack - 1.5"	SDR 11/13.5
08761385	Duck Pack - 2"	SDR 11/13.5

Cable Packs (minimum of one required)

Part Number	Description	
08782638	0.49"-0.60"	(12.4-15.3 mm)
08782637	0.61"-0.73"	(15.4-18.5 mm)
08782636	0.74"-0.85"	(18.6-21.6 mm)
08782635	0.86"-0.97"	(21.7-24.6 mm)
08782634	0.98"-1.13"	(24.7-28.7 mm)
08782633	1.14"-1.25"	(28.8-31.8 mm)
08782632	1.26"-1.34"	(31.9-34.0 mm)
08782631	1.35"-1.54"	(34.1-39.1 mm)

Y-Block

The Condux "Y"-Block is designed for installing a micro duct or fiber cable into an existing occupied duct, when coupled to the Gulfstream 400 Fiber Optic Cable Blower.

Part Number	Description
08761850	Y-Block

Common Parts Package: (Included with all Y-Blocks).

Part Number	Description
02283800	All Wrench ³ / ₃₂
02283900	Socket Hex Deep Well ¹¹ / ₁₆ "
02284000	Ratchet, ³ / ₈ " Drive 6.75 in Long
08761443	Seal Kit Replacement
08761868	Inflatable Shuttle for 1.00-1.25
08761869	Inflatable Shuttle for 1.50-2.00
08761884	Cable Seal for .35-.50 Cable
08761885	Cable Seal for .51-.90 Cable
08761438	Capscrew Set

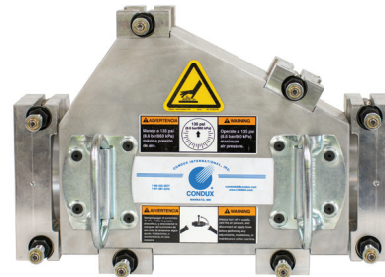

Y-Block Duct Packs (sold separately)

(Each duct pack comes with 2-seals & 2-clamps).

Part Number	Description	Duct OD
08761386	Y Block Duct Pack - 1.315 (33.4)	1.315"
08761826	Y Block Duct Pack - 1.570 (40.0)	1.570"
08761387	Y Block Duct Pack - 1.660 (42.2)	1.660"
08761388	Y Block Duct Pack - 1.900 (48.3)	1.900"
08761389	Y Block Duct Pack - 2.375 (60.3)	2.375"

Features & Benefits

- Portable
- Easy to Use
- Duct Range 1.315" – 2.375" (33 mm - 60 mm) OD
- Cable Seal Range 0.35" – 0.90" (9 mm - 23 mm) OD
- Aluminum Construction
- Built-in Carrying Handles
- Canvas Storage Bag

Low PSI Shuttles

These unique, flexible shuttles are available in triple parachute configuration, making rope, pull tape and fiber optic cable installation in occupied duct a breeze. These shuttles can be used on their own or in series allowing for up to six parachutes to capture the air within the conduit, which can help increase installation distances. The parachutes collapse without constant air pressure allowing for easy pullback. Rated for 3 psi.

Part Number	Duct Size	
	(in)	(mm)
08761868	1.00-1.25	25-32
08761869	1.50-2.00	38-50

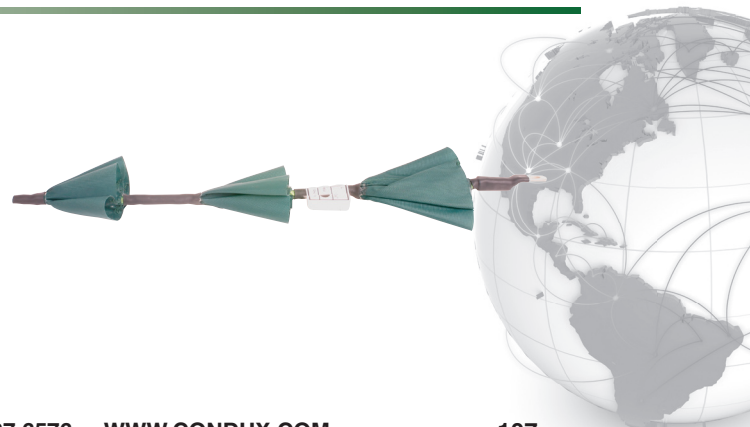



MINI-BLOWER PUSHER

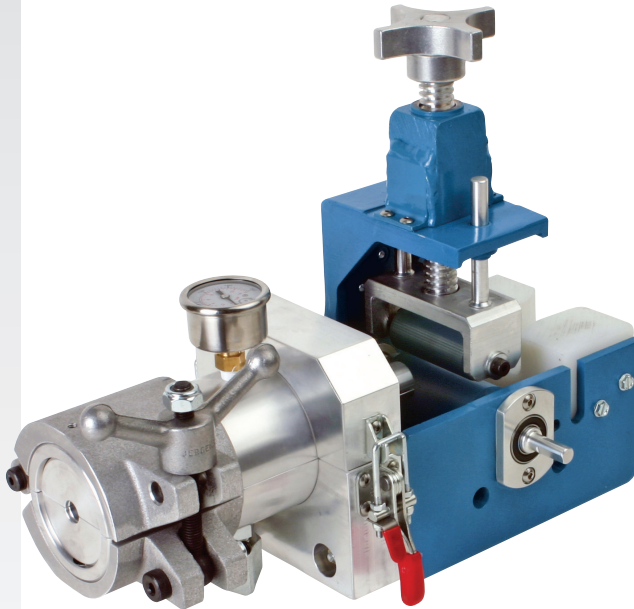

Mini-Blower/Pusher

The Mini-Blower/Pusher from Condux is the lightweight, portable solution for easy installation of micro fiber and traditional fiber optic cable. The compact unit is ideally suited for your most difficult job sites and "last mile" fiber installations.

Backed by years of fiber blowing experience, the Mini-Blower/Pusher is designed for the installation of fiber optic cables with diameters from 0.23" (5.8 mm) to 0.50" (12.7 mm) into micro duct 10 mm to 18 mm or traditional duct from 0.50" (12.7 mm) to 2" (50.8 mm).

Part Number	Description
08780800	Mini-Blower/Pusher
08780801	Mini-Blower/Pusher Job Box with Kit for 12 mm & 12.7 mm duct and includes cable packs 1 & 2 in the Mini-Blower/Pusher cable pack chart on page 109 (08780802, 08780804)
08780865	Mini-Blower/Pusher Job Box with Kit for 3/4" & 1 1/4" duct and includes cable packs 1, 2 & 3 in the Mini-Blower/Pusher cable pack chart on page 109 (08780802, 08780804, 08780806)
08780860	Job Box Only

Replacement Parts

Part Number	Description
08081320	Flat Roller for Flat Fiber
08081319	V-Grooved Roller Bottom
08081313	Top Roller Sleeve



! See page 109 for Cable Packs and page 104 for Duct Packs.



Heavy Duty Tripod

The Mini-Blower/Pusher mounts easily to the surveyor style tripod, which adds stability and versatility to fiber optic cable installations.

Part Number	Description
08780850	Heavy Duty Tripod





MINI-BLOWER PUSHER ACCESSORIES



Cable Packs: Mini-Blower/Pusher

Pack	Cable Pack		Venturi		Cable Seal		Cable Grips
	Cable OD	Part Number	Cable OD	Part Number	Cable OD	Part Number	Part Number
1	0.23" - 0.34" (5.8 mm - 8.8 mm)	08780802	0.23" - 0.34" (5.8 - 8.8)	08780803	0.23" - 0.28" (5.8 - 7.2)	08780406	08643754
					0.29" - 0.34" (7.3 - 8.8)	08780407	
2	0.35" - 0.48" (8.9 mm - 12.2 mm)	08780804	0.35" - 0.48" (8.9 - 12.2)	08780805	0.35" - 0.42" (8.9 - 10.7)	08761424	08643755
					0.43" - 0.48" (10.8 - 12.2)	08761425	
3	0.49" - 0.60" (12.3 mm - 15.2 mm)	08780806	0.49" - 0.60" (12.3 - 15.2)	08780807	0.49" - 0.55" (12.3 - 14.0)	08761426	08643756
					0.56" - 0.60" (14.1 - 15.2)	08761427	
4	(10.4 mm x 5.5 mm)	08781117	Nylatron Venturi for Flat Fiber Optic Cables				
5	(15.2 mm x 6.7 mm)	08781118	Nylatron Venturi for Flat Fiber Optic Cables				

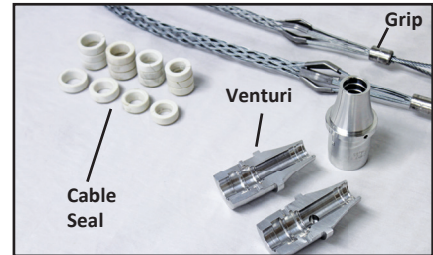

(See page 104 for Duct Packs)

Polywater® Prelube 5000™

Polywater® Prelube 5000™ is more concentrated than the Prelube 2000™. It is intended for blowing microcable into small diameter microtubes. The improved chemistry allows this product to spread further and reduce friction levels. The lower viscosity allows practical application into the microtubes.



Part Number	Description	Min. Order Qty.
08230675	Polywater® Prelube 5000™ 8 oz Bottle	6 Bottles

FIBER CABLE INSTALLATION





GULFSTREAM™ 350



(20-Volt DeWalt battery & charger not included with blower)

Gulfstream™ 350 Blower

The new Condux Gulfstream 350 Fiber Optic Cable Blower is all pneumatic and comes complete with a convenient storage case. With the ability to install fiber from 0.16" - 0.62" (4 - 16 mm) into duct ranging from 0.50" - 1.25" (8 - 42 mm), the Gulfstream 350 provides a mechanical counter, speed indicator, and maximum belt visibility. Complete the order with cable packs and duct packs on page 120 and 121 to meet the exact job requirements.

Gulfstream™ 350 Micro Fiber Blower

Part Number	Description
08784601	Gulfstream 350™ Pneumatic Blower
08784605	Gulfstream 350E™ Pneumatic Blower with Recording
02292142	Work Folding Table (21.7 x 33.5 x 29.7 in)

Gulfstream 350 Cable Packs

Cable Pack		Venturi		Cable Seal		Cable Grip					
Cable OD	Part Number	Cable OD	Part Number	Cable OD	Part Number	Cable OD	Part Number				
0.16" - 0.18" (4.0 - 4.5 mm)	08781160	0.16" - 0.18" (4.0 - 4.5 mm)	08781165	4.0 mm	08780960K	0.10" - 0.22" (2.5 - 5.6 mm)	08643753				
				4.5 mm	08780961K						
0.18" - 0.31" (4.6 - 8.0 mm)	08781161	0.18" - 0.31" (4.6 - 8.0 mm)	08781166	5.0 mm	08780962K	0.10" - 0.22" (2.5 - 5.6 mm)	08643753				
				5.5 mm	08780963K						
				6.0 mm	08780964K						
				0.32" - 0.47" (8.1 - 12.0 mm)	08781162	0.32" - 0.47" (8.1 - 12.0 mm)	08781167	6.5 mm	08780965K	0.21" - 0.35" (5.3 - 8.9 mm)	08643754
								7.0 mm	08780966K		
								7.5 mm	08780967K	0.32" - 0.48" (8.1 - 12.2 mm)	08643755
								8.0 mm	08780968K		
8.5 mm	08780969K										
0.48" - 0.61" (12.1 - 15.5 mm)	08781163	0.48" - 0.61" (12.1 - 15.5 mm)	08781168	9.0 mm	08780970K	0.42" - 0.61" (10.7 - 15.5 mm)	08643756				
				9.5 mm	08780971K						
				10.0 mm	08780972K						
				10.5 mm	08780973K						
				11.0 mm	08780974K						
				11.5 mm	08780975K						
0.61" - 0.65" (15.6 - 16.5 mm)	08781164	0.61" - 0.65" (15.6 - 16.5 mm)	08781169	12.0 mm	08780976K	0.53" - 0.74" (13.5 - 18.8 mm)	08643757				
				12.5 mm	08780977K						
10.4 x 5.5 mm	08781117			13.0 mm	08780978K						
				13.5 mm	08780979K						
				14.0 mm	08780980K						
				14.5 mm	08780981K						
15.2 x 6.7 mm	08781118			15.0 mm	08780982K						
				15.5 mm	08780983K						
				16.0 mm	08780984K						
				16.5 mm	08780985K						
				(Nylatron venturi for flat fiber cables)							
				(Nylatron venturi for flat fiber cables)							

Gulfstream 350 Duct Packs

Duct Size OD (MM)	Part Number	Duct Clamp	Duct Seal	End Stop Connector
8	08764160	08764162	08764163	08566336
8.5	08764175	08764169	08764171	08566323
10	08764140	08764142	08764143	08566325
12	08764110	08764112	08764113	08566327

Duct Size OD (MM)	Part Number	Duct Clamp	Duct Seal	End Stop Connector
12.7	08764150	08764151	08764153	08566338
14	08764120	08764122	08764123	08566328
16	08764130	08764132	08764133	08566329
18	08781110	08781106	08781101	08566334



CONDUX
Gulfstream 350 Duct Packs (continued)

Duct Pack		Duct Clamp		Duct Seal		Carrier		Foam Carrier		Cable Grip		Innerduct Eye
Duct Size	Part Number	Duct OD (mm)	Part Number	Duct OD (mm)	Part Number	Carrier OD (mm)	Part Number	Carrier OD (mm)	Part Number	Duct OD (mm)	Part Number	Part Number and ID Range (mm)
1/2" SDR 11-13.5	08780795	0.840" (21.3)	08780791	0.840" (21.3)	08780786	0.688" (17.50)	08780793	0.75" (19.0)	08078300	.75-.99" (19-25)	08643131	08913342 .71-.77" (18-20)
3/4" (27mm) SDR 11-13.5	08780680	1.050" (26.6)	08780682	1.050" (26.6)	08780685	0.75" (19.0)	08780690	0.75" (19.0)	08078300	1.00-1.24" (25.4-31.5)	08643137	08761840 .71-.87" (18-22)
1" SDR 11/13.5	08780386	1.315" (33.4)	08780369	1.315" (33.4)	08780307	1.121" (28.5)	08761250	1.25" (31.8)	08761439	1.25-1.49" (32-38)	08643143	08913343 .75-1.00" (19-25)
1.25" SDR 11/13.5	08780392	1.660" (42.2)	08780375	1.660" (42.2)	08780051	1.414" (35.9)	08761255	1.50" (38.1)	08761440	1.50-1.99" (38.1-50.5)	08643149	08761842 1.06-1.43" (27-37)
20mm	08781120	0.787" (20.0)	08781122	0.787" (20.0)	08781121	0.688" (17.5)	08780793	1.00" (25.4)	08761444	.75-.99" (19.0-25.1)	08643131	08914007 .551-.813" (14-20)
22mm	08781153	0.886" (22.0)	08781154	0.886" (22.0)	08781155	0.688" (17.5)	08780793	1.00" (25.4)	08761444	.75-.99" (19.0-25.1)	08643131	08914007 .551-.813" (14-20)
25mm	08780240	0.984" (25.0)	08780099	0.984" (25.0)	08780134	0.787" (20.0)	08780230	1.25" (31.8)	08761439	1.25-1.49" (31.8-37.8)	08643137	08761840 .71-.87" (18-22)
32mm	08780385	1.260" (32.0)	08780368	1.260" (32.0)	08780306	1.063" (27.0)	08761560	1.25" (31.8)	08761439	1.25-1.49" (31.8-37.8)	08643143	08761842 1.06-1.43" (27-37)
36mm	08780387	1.417" (36.0)	08780370	1.417" (36.0)	08780308	1.181" (30.0) 1.220" (31.0)	08761643 08761555	1.25" (31.8)	08761439	1.25-1.49" (31.8-37.8)	08643143	08761842 1.06-1.43" (27-37)
37mm	08780388	1.457" (37.0)	08780371	1.457" (37.0)	08780309	1.220" (31.0)	08761555	1.25" (31.8)	08761439	1.25-1.49" (31.8-37.8)	08643143	08761842 1.06-1.43" (27-37)
1.25" TRUE	08780389	1.500" (38.1)	08780372	1.500" (38.1)	08780333	1.250" (31.7)	08761670	1.50" (38.1)	08761440	1.25-1.49" (31.8-37.8)	08643143	08761842 1.06-1.43" (27-37)
40mm	08780390	1.575" (40.0)	08780373	1.575" (40.0)	08780334	1.299" (33.0)	08761525	1.50" (38.1)	08761440	1.50-1.99" (38.1-50.5)	08643149	08761842 1.06-1.43" (27-37)
42mm	08780391	1.653" (42.0)	08780374	1.653" (42.0)	08780335	1.378" (35.0)	08761660	1.50" (38.1)	08761440	1.50-1.99" (38.1-50.5)	08643149	08761844 1.37-1.68" (35-43)

FIBER CABLE INSTALLATION

Gulfstream 350 Blower Size

- Dimensions: 606 mm (l) x 341 mm (w) x 299 mm (h)
23.8" (l) x 13.4" (w) x 11.8" (h)
- Weight: 55 lbs/25 kg

Duct Range

- 8 mm - 42 mm
- .50" - 1.25"

Fiber Cable Range

- 4 mm - 16.5 mm (.16" - .65")

Features

- Mechanical Counter/Real Time Distance (Meters and Feet)
- Speed Indicator (Meters and Feet)
- No Tools Required for Belt Replacement
- Maximum Belt Visibility, Transparent Covers for Easy Monitoring
- Emergency Stop Button
- Air Conditioning: Filter, Regulator, and Lubricator
- Lightweight Case

Drive

- Pneumatic Drive System
- Maximum push force of 310 N (70 lbs)
- Average Speed: 52 m/min @ 178 N (170 ft/min @ 40 lbs)

Pressure and Flow

Microduct:

- Air Pressure Requirements (BAR)*: 10-15 Bar
- Air Pressure Requirements (PSI)*: 150-205 PSI
- Flow Requirements (CMM)*: 0.5-1.5 CMM
- Flow Requirements (CFM)*: 10-35 CFM

Traditional Duct:

- Air Pressure Requirements (BAR)*: 7-10 Bar
- Air Pressure Requirements (PSI)*: 100-150 PSI
- Flow Requirements (CMM)*: 5-11 CMM
- Flow Requirements (CFM)*: 185-375 CFM

*Air pressure and flow requirements depend on the size of duct and the size of fiber being installed into that duct.





GULFSTREAM™ 300

Gulfstream™ 300 Micro Fiber Blower

The Gulfstream 300 is an effective and economical approach to middle mile fiber installations. Able to install fiber optic cable ranging in size from 2.5 mm to 8 mm into duct from 7 mm to 18 mm, the Gulfstream 300 offers the portability, convenience and power for standard middle mile projects in a cost effective package. Weighing just 9 lbs. (4.1 kg), the Gulfstream 300 is easily transported and can be mounted on a tripod for optimum productivity.

***The Gulfstream 300 no longer uses batteries for power. 48v power supply included with kits**

Gulfstream™ 300 Micro Fiber Blower Kits

Part Number	Description
08787001	Gulfstream 300™ Micro Fiber Blower Standard Kit, US*
08787002	Gulfstream 300™ Micro Fiber Blower Standard Kit, Int'l*
08787003	Gulfstream 300™ Micro Fiber Blower Base Kit, US
08787004	Gulfstream 300™ Micro Fiber Blower Base Kit, Int'l

Included in standard kits:

Part Number	QTY	Description
02290961	1	Plastic Case
02291020	1	Hex Key Set
08784011	1	Large V-Groove Belt, GS300 QC
08783076	1	Seal Kit
08783519	1	O-Ring Kit (qty 5)
08787018	1	Flat Belt, GS300 QC
08787021	1	Rear Insert Guide (3-4mm)
08787022	1	Rear Insert Guide (5-7mm)
08787023	1	Rear Insert Guide (8-10mm)
08787060	1	AC Power Supply, 48v - US
08783508	1	AC Power Supply, 48v - Int'l (must install appropriate plug)
08782212	1	Tripod Plate, 5/8" to 1/4" Adapter
02290383	1	Adjustable HD Tripod, 42"- 65"
08787066	1	Quick Change Tool

Cable Seals and Duct Packs noted with (*) on page 113 included in kits

Included in base kits:

Part Number	QTY	Description
02290961	1	Plastic Case
02291020	1	Hex Key Set
08784011	1	Large V-Groove Belt, GS300 QC
08783076	1	Seal Kit
08783519	1	O-Ring Kit (qty 5)
08787018	1	Flat Belt, GS300 QC
08787021	1	Rear Insert Guide (3-4 mm)
08787022	1	Rear Insert Guide (5-7 mm)
08787023	1	Rear Insert Guide (8-10 mm)
08787060	1	AC Power Supply, 48v - US
08783508	1	AC Power Supply, 48v - Int'l (must install appropriate plug)
08787066	1	Quick Change Tool

Cable Seals, Duct Packs, Tripod and Tripod Plate are sold individually



Blower Size

- Dimensions: 11" (l) x 8" (w) x 6" (h)
279 mm (l) x 203 mm (w) x 152 mm (h)
- Weight: 9 lbs/4.1 kg

Microduct Range

- 7 – 18 mm
- Built in clamping system with interchangeable seals

Fiber Cable Range

- 2.5 – 8 mm

Power System

- Electric drive motor
- **48v AC Power Supply**
(Plugged into wall or 1000 w Generator)

Drive

- Belt drive
- Maximum push force of 30 lbs (133 N)
- Speed: 0-230 fpm (0 – 70mpm) with 48V inverter

Controls

- Forward/reverse switch
- Speed control to regulate motor speed
- Emergency stop button for instant shutdown
- Screen that monitors speed, distance and life counter
- Push force adjustment

Pressure and Flow

- Air connections: 3/8" EU or US Coupling
- Air Pressure Requirements (BAR)*: 10-15 Bar
- Air Pressure Requirements (PSI)*: 150-205 PSI
- Flow Requirements (CMM)*: 0.5-1.5 CMM
- Flow Requirements (CFM)*: 10-35 CFM

*Air pressure and flow requirements depends on the size of duct and the size of fiber being installed into that duct.

Gulfstream™ 300 Micro Fiber Blower Replacement Parts

Replacement Cable Seals

Part Number	Description
08783792	2.5 mm Cable Seal Kit (6 pcs)*
08783644	3.0 mm Cable Seal Kit (6 pcs)*
08783737	3.25 mm Cable Seal Kit (6 pcs)
08783645	3.5 mm Cable Seal Kit (6 pcs)*
08783739	3.75 mm Cable Seal Kit (6 pcs)
08783646	4.0 mm Cable Seal Kit (6 pcs)*
08783741	4.25 mm Cable Seal Kit (6 pcs)
08783647	4.5 mm Cable Seal Kit (6 pcs)*
08783743	4.75 mm Cable Seal Kit (6 pcs)
08783648	5.0 mm Cable Seal Kit (6 pcs)*
08783649	5.5 mm Cable Seal Kit (6 pcs)*
08783650	6.0 mm Cable Seal Kit (6 pcs)*
08783651	6.5 mm Cable Seal Kit (6 pcs)*
08783652	7.0 mm Cable Seal Kit (6 pcs)*
08783653	7.5 mm Cable Seal Kit (6 pcs)*
08783654	8.0 mm Cable Seal Kit (6 pcs)*
08783655	8.5 mm Cable Seal Kit (6 pcs)*
08783656	9.0 mm Cable Seal Kit (6 pcs)*
08783657	9.5 mm Cable Seal Kit (6 pcs)*
08783658	10.0 mm Cable Seal Kit (6 pcs)*
08783659	10.5 mm Cable Seal Kit (6 pcs)*
08783660	Cable Seal Kit Blanks (6 pcs)*
08783666	Flat Cable Seal Kit 8.1 mm x 4.5 mm (6 pcs)



*Included in Gulstream 300 standard blower kit

Replacement Duct Packs

Part Number	Description
08787035	7.0mm Duct Pack Assembly (includes 10 O-Rings)*
08787055	8.0mm Duct Pack Assembly (includes 10 O-Rings)*
08787037	8.5mm Duct Pack Assembly (includes 10 O-Rings)*
08787038	10.0mm Duct Pack Assembly (includes 10 O-Rings)*
08787042	12.0mm Duct Pack Assembly (includes 10 O-Rings)*
08787043	12.7mm Duct Pack Assembly (includes 10 O-Rings)*
08787028	14.0mm Duct Pack Assembly (includes 10 O-Rings)*
08787029	16.0mm Duct Pack Assembly (includes 10 O-Rings)*
08787045	18.0mm Duct Pack Assembly (includes 10 O-Rings)*

*Included in Gulstream 300 standard blower kit



Replacement O-Rings

Part Number	Description
08783192	7.0 mm Duct O-Ring Kit (12 pcs)
08783193	8.0 mm Duct O-Ring Kit (12 pcs)
08783194	8.5 mm Duct O-Ring Kit (12 pcs)
08783195	10.0 mm Duct O-Ring Kit (12 pcs)
08783196	12.0 mm Duct O-Ring Kit (12 pcs)
08783197	12.7 mm Duct O-Ring Kit (12 pcs)
08783641	14.0 mm Duct O-Ring Kit (12 pcs)
08783642	16.0 mm Duct O-Ring Kit (12 pcs)
08783643	18.0 mm Duct O-Ring Kit (12 pcs)

Gulfstream™ 300 Micro Fiber Blower Accessories

Part Number	Description
02290383	Adjustable HD Tripod, 42"- 65"
08782212	Tripod Plate, 5/8" to 1/4" Adapter
08787060	AC Power Supply, 48v - US
08783508	AC Power Supply, 48v - Int'l (must install appropriate plug)
08783392	GS250/300 Flow Regulator Kit
08783393	GS250/300 Flow Regulator Kit - Int'l Fittings
08783301	GS250/300 Proof/Pressure Test Kit
08783878	Wet Fat Belt with Groove QC (qty 2 req'd)
08783670	36V DeWalt Battery Assembly Adapter





GULFSTREAM™ 250

Gulfstream™ 250 Micro Fiber Blower

The Gulfstream 250 is an effective and economical approach to middle mile fiber installations. Able to install fiber optic cable ranging in size from 2.5 mm - 8mm into duct from 5 mm - 18 mm, the Gulfstream 250 offers portability, convenience and power for standard middle projects in a cost effective package. The unit features user-friendly controls that help optimize the fiber optic cable installation process.

***The Gulfstream 250 no longer uses batteries for power. 48v power supply included with kits**

Gulfstream™ 250 Micro Fiber Blower Complete Kit

Part Number	Description
08783805-50	Gulfstream 250™ Micro Fiber Blower Standard Kit, US*
08783805-51	Gulfstream 250™ Micro Fiber Blower Standard Kit, Int'l*
08783805-53	Gulfstream 250™ Micro Fiber Blower Base Kit, US
08783805-54	Gulfstream 250™ Micro Fiber Blower Base Kit, Int'l

Included in standard kits:

Part Number	Description
02290961	Plastic Case
02291020	Hex Key Set
08783427	Large Groove Green Belt
08783076	Seal Kit
08783519	O-Ring Kit (qty 5)
08783425	Flat Orange Belt
08783770	Rear Insert Guide (3-4 mm)
08787771	Rear Insert Guide (4-7 mm)
08787772	Rear Insert Guide (7-10 mm)
08787060	AC Power Supply, 48v - US
08783508	AC Power Supply, 48v - Int'l (must install appropriate plug)
08782212	Tripod Plate, 5/8" to 1/4" Adapter
02290383	Adjustable HD Tripod, 42"- 65"
08787066	Quick Change Tool

Cable Seals and Duct Packs noted with (*) on page 115 included in kits

Included in base kits:

Part Number	Description
02290961	Plastic Case
02291020	Hex Key Set
08783427	Large Groove Green Belt
08783076	Seal Kit
08783519	O-Ring Kit (qty 5)
08783425	Flat Orange Belt
08783770	Rear Insert Guide (3-4 mm)
08787771	Rear Insert Guide (4-7 mm)
08787772	Rear Insert Guide (7-10 mm)
08787060	AC Power Supply, 48v - US
08783508	AC Power Supply, 48v - Int'l (must install appropriate plug)
08787066	Quick Change Tool

Cable Seals, Duct Packs, Tripod and Tripod Plate are sold individually

Specialty Wheels

Fiber Cable Range

2.5 - 4mm

08783819 - Wheel, Specialty Fat, Groove Orange (2 req'd)

3.5 - 4.3mm

08783884 - Wet Wheel, Serrated (1 req'd)

4.4 - 5.5mm

08783885 - Wet Wheel, Serrated (1 req'd)

5.6 - 7.75mm

08783886 - Wet Wheel, Serrated (1 req'd)

7.75 - 9.75mm

08783887 - Wet Wheel, Serrated (1 req'd)

specialty wheels purchased separately

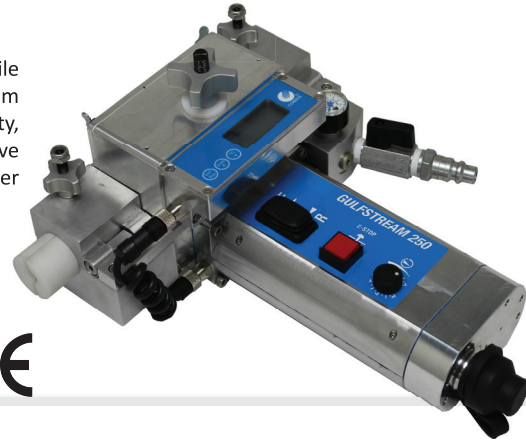

Blower Size

- Dimensions: 11" (l) x 8" (w) x 6" (h)
279 mm (l) x 203 mm (w) x 152 mm (h)
- Weight: 9 lbs/4.1 kg

Microduct Range

- 5 – 18 mm
- Built in clamping system with interchangeable seals

Fiber Cable Range

- 2.5 – 8 mm
- 8.1 - 9.75 mm (with specialty wheels, not included in kit)

Power System

- Electric drive motor
- **48v AC Power Supply**
(Plugged into wall or 1000 w Generator)

Drive

- Wheel drive
- Maximum push force of 30 lbs (133 N)
- Speed: 0-230 fpm (0 – 70 mpm) with 48V inverter

Controls

- Forward/reverse switch
- Speed control to regulate motor speed
- Screen that monitors speed, distance and life counter
- Emergency stop button for instant shut down
- Push force adjustment

Pressure and Flow

- Air connections: 3/8" EU or US Coupling
- Air Pressure Requirements (BAR)*: 10-15 Bar
- Air Pressure Requirements (PSI)*: 150-205 PSI
- Flow Requirements (CMM)*: 0.5-1.5 CMM
- Flow Requirements (CFM)*: 10-35 CFM

*Air pressure and flow requirements depends on the size of duct and the size of fiber being installed into that duct.

Gulfstream™ 250 Micro Fiber Blower Replacement Parts

Replacement Cable Seals

Part Number	Description
08783792	2.5 mm Cable Seal Kit (6 pcs)*
08783644	3.0 mm Cable Seal Kit (6 pcs)*
08783645	3.5 mm Cable Seal Kit (6 pcs)*
08783646	4.0 mm Cable Seal Kit (6 pcs)*
08783647	4.5 mm Cable Seal Kit (6 pcs)*
08783648	5.0 mm Cable Seal Kit (6 pcs)*
08783649	5.5 mm Cable Seal Kit (6 pcs)*
08783650	6.0 mm Cable Seal Kit (6 pcs)*
08783651	6.5 mm Cable Seal Kit (6 pcs)*
08783652	7.0 mm Cable Seal Kit (6 pcs)*
08783653	7.5 mm Cable Seal Kit (6 pcs)*
08783654	8.0 mm Cable Seal Kit (6 pcs)*
08783660	Cable Seal Blanks (6 pcs)*
08783655	8.5 mm Cable Seal Kit (6 pcs)
08783656	9.0 mm Cable Seal Kit (6 pcs)
08783657	9.5 mm Cable Seal Kit (6 pcs)
08783658	10.0 mm Cable Seal Kit (6 pcs)
08783666	Flat Cable Seal Kit 8.1 mm x 4.5 mm (6 pcs)

*Included in Gulfstream 250 standard blower kit



Replacement Duct Packs

Part Number	Description
08783812	5.0 mm Duct Pack Assembly (includes 10 O-Rings)*
08783813	6.0 mm Duct Pack Assembly (includes 10 O-Rings)*
08783832	7.0 mm Duct Pack Assembly (includes 10 O-Rings)*
08783833	8.0 mm Duct Pack Assembly (includes 10 O-Rings)*
08783834	8.5 mm Duct Pack Assembly (includes 10 O-Rings)*
08783634	10.0 mm Duct Pack Assembly (includes 10 O-Rings)*
08783635	12.0 mm Duct Pack Assembly (includes 10 O-Rings)*
08783636	12.7 mm Duct Pack Assembly (includes 10 O-Rings)*
08783637	14.0 mm Duct Pack Assembly (includes 10 O-Rings)*
08783638	16.0 mm Duct Pack Assembly (includes 10 O-Rings)*
08783639	18.0 mm Duct Pack Assembly (includes 10 O-Rings)*

*Included in Gulfstream 250 standard blower kit



Replacement O-Rings

Part Number	Description
08783190	5.0 mm Duct O-Ring Kit (12 pcs)
08783191	6.0 mm Duct O-Ring Kit (12 pcs)
08783192	7.0 mm Duct O-Ring Kit (12 pcs)
08783193	8.0 mm Duct O-Ring Kit (12 pcs)
08783194	8.5 mm Duct O-Ring Kit (12 pcs)
08783195	10.0 mm Duct O-Ring Kit (12 pcs)
08783196	12.0 mm Duct O-Ring Kit (12 pcs)
08783197	12.7 mm Duct O-Ring Kit (12 pcs)
08783641	14.0 mm Duct O-Ring Kit (12 pcs)
08783642	16.0 mm Duct O-Ring Kit (12 pcs)
08783643	18.0 mm Duct O-Ring Kit (12 pcs)

Gulfstream™ 250 Micro Fiber Blower Accessories

Part Number	Description
02290383	Adjustable HD Tripod, 42" - 65"
08782212	Tripod Plate, 5/8" to 1/4" Adapter
08787060	AC Power Supply, 48v - US
08783508	AC Power Supply, 48v - Int'l (must install appropriate plug)
08783670	36V DeWalt Battery Assembly Adapter
08783392	GS250/300 Flow Regulator Kit
08783393	GS250/300 Flow Regulator Kit - Int'l Fittings
08783301	GS250/300 Proof/Pressure Test Kit
08787066	Quick Change Tool

For additional wheel options, see 'Specialty Wheels' on page 114





GULFSTREAM™ 150

Gulfstream™ 150 Micro Fiber Blower

The Gulfstream 150 micro fiber blower is designed for FTTx and Enterprise micro fiber cable installation projects. The self-contained Gulfstream 150 combines the push force of a small electric motor driven belt drive with compressed air to quickly and easily install microfiber cables from 1.0 mm to 2.5 mm in diameter into microduct ranging in size from 5 mm to 8.0 mm, at speeds up to 375 feet per minute.

The unit's machined aluminum construction provides a lightweight profile with long life and durability. The Gulfstream 150's compact size and convenient carrying case allow for easy transport between job sites.

***The Gulfstream 150 no longer includes a battery or charger.**

Requirements listed below and must be sourced by installer.

Gulfstream™ 150 Micro Fiber Blower Complete Kit

Part Number	Description
08783400-50	Gulfstream 150™ Micro Fiber Blower Standard Kit, US*
08783400-51	Gulfstream 150™ Micro Fiber Blower Standard Kit, Int'l*
08783400-53	Gulfstream 150™ Micro Fiber Blower Base Kit, US
08783400-55	Gulfstream 150™ Micro Fiber Blower Base Kit, Int'l

Included in standard kits:

Part Number	QTY	Description
08783054	1	Plastic Case
02291020	1	Hex Key Set
08783426	2	Small Groove Wheel
08783076	1	Seal Kit
08783077	1	O-Ring Kit (qty 5)
02290882	1	Adjustable Tripod, 9lbs, 11" - 63"
02291088	1	3 Pin Cordset
08783026	1	Belt Battery Clip
08783259	1	Blank Seal Kit (qty 6)

Cable Seals and Duct Packs noted with (*) on page 117 included in kits

Included in base kits:

Part Number	QTY	Description
08783054	1	Plastic Case
02291020	1	Hex Key Set
08783426	2	Small Groove Wheel
08783076	1	Seal Kit
08783077	1	O-Ring Kit (qty 5)
02291088	1	3 Pin Cordset
08783026	1	Belt Battery Clip
08783259	1	Blank Seal Kit (qty 6)

Cable Seals, Duct Packs, and Tripod are sold individually.

Battery/Charger Requirements

DeWalt Li-Ion Battery -12.0v
 DeWalt Li-Ion Charger 12v/20V

DeWalt Li-Ion Battery - 10.8v
 DeWalt Li-Ion Charger 10.8v



Blower Size

- Dimensions: 8" (l) x 6" (w) x 6" (h)
203 mm (l) x 152 mm (w) x 152 mm (h)
- Weight: 7 lbs/3.2 kg

Microduct Range

- 5 – 8 mm
- Built in clamping system with interchangeable seals

Fiber Cable Range

- 1 – 2.5 mm

Power System

- Electric drive motor
- 12v (US) or 10.8v (EU) Cordless Battery (not included)
- AC Power Supply (optional)

Drive

- Roller Cover
- Maximum push force of 4.5 lbs (20 N)
- Speed: 0-375 fpm (0 – 115 mpm)

Controls

- Screen that monitors speed and distance - life counter
- Forward/Reverse switch
- Speed control to regulate motor speed
- Push force adjustment

Pressure and Flow

- Air connections: 1/4" EU or US Coupling
- Air Pressure Requirements (BAR)*: 10-15 Bar
- Air Pressure Requirements (PSI)*: 150-205 PSI
- Flow Requirements (CMM)*: 0.5-1.5 CMM
- Flow Requirements (CFM)*: 10-35 CFM

*Air pressure and flow requirements depends on the size of duct and the size of fiber being installed into that duct.

Gulfstream™ 150 Micro Fiber Blower Replacement Parts

Replacement Cable Seals

Part Number	Description
08783448	1.25 mm Cable Seal Kit (6 pcs)*
08783449	1.50 mm Cable Seal Kit (6 pcs)*
08783450	1.75 mm Cable Seal Kit (6 pcs)*
08783451	2.00 mm Cable Seal Kit (6 pcs)*
08783452	2.25 mm Cable Seal Kit (6 pcs)*
08783453	2.50 mm Cable Seal Kit (6 pcs)*
08783259	Cable Seal Kit Blanks (6 pcs)*

*Included in Gulfstream 150 standard blower kit



Duct Packs

Part Number	Description
08783170	5.0 mm Duct Pack Assembly (includes 10 O-Rings)*
08783171	6.0 mm Duct Pack Assembly (includes 10 O-Rings)*
08783172	7.0 mm Duct Pack Assembly (includes 10 O-Rings)*
08783173	8.0 mm Duct Pack Assembly (includes 10 O-Rings)*

*Included in Gulfstream 150 standard blower kit



Replacement O-Rings

Part Number	Description
08783190	5.0 mm Duct O-Ring Kit (12 pc)
08783191	6.0 mm Duct O-Ring Kit (12 pc)
08783192	7.0 mm Duct O-Ring Kit (12 pc)
08783193	8.0 mm Duct O-Ring Kit (12 pc)

Accessories for Gulfstream™ 150 Micro Fiber Blower

Part Number	Description
08783390	Gulfstream™ 150 Flow Regulator
08783391	Gulfstream™ 150 Flow Regulator - Intl Fittings
02290882	Tripod
08783090	AC Power Supply - Int'l (must install appropriate plug)
08783301	GS150 Proof/Pressure Test Kit
08783085	A/C Power Supply - US
08783457	Hose Assembly, Claw to QD GS150 INTL





CABLE BLOWING LUBRICANTS/CABLE TIPS



Polywater® Prelube 2000™

Specially formulated for use with Fiber Optic Cable Blowing Systems, Polywater® Prelube 2000™ has been field proven with Condux Gulfstream Fiber Optic Cable Blowers. This lubricant is a special lubricant used to prelubricate the conduit system before installing the cable. Prelube 2000 is compatible with all types of cable jackets and conduit types.

Part Number	Description	Min. Order Qty.
08230600	1 Quart (0.9 liter) Standard Grade	12 Quarts
08230601	1 Gallon (3.8 liter) Standard Grade	4 Gallons
08230605	5 Gallon (19 liter) Standard Grade	1 Pail (5 Gallon)

Polywater® W-Prelube 2000™

Polywater® W-Prelube 2000™ Winter Grade is a non-freezing form of the standard Polywater Prelube 2000™

Part Number	Description	Min. Order Qty.
08230900	1 Quart (0.9 liter) Winter Grade	12 Quarts
08230901	1 Gallon (3.8 liter) Winter Grade	4 Gallons
08230905	5 Gallon (19 liter) Winter Grade	1 Pail (5 Gallon)

Polywater® Prelube 5000™

Is more concentrated than the Prelube 2000™. It is intended for blowing microcable into small diameter microtubes. The improved chemistry allows this product to spread further and lower friction at extremely low coating levels. The lower viscosity allows practical application into the microtubes.

Part Number	Description	Min. Order Qty.
08230675	8-fl ounce (227 g) squeeze bottle	6 Bottles

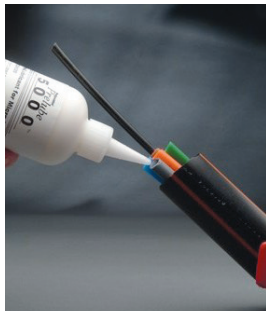

Cable Tips

These tips screw onto fiber optic cable to assist in guiding the fiber through sharp corners and couplings. Sizes range from 2 - 9 mm in 1/2 mm increments. **Note: the actual tip diameter is 1/2 mm larger than cable diameter (ex: the outer diameter of a tip for 4 mm cable (08783978) will measure 4.5 mm).**



Part Number	Description
08783970	2.0 mm Cable Tips (10 pcs)
08783972	2.5 mm Cable Tips (10 pcs)
08783974	3.0 mm Cable Tips (10 pcs)
08783976	3.5 mm Cable Tips (10 pcs)
08783978	4.0 mm Cable Tips (10 pcs)
08783980	4.5 mm Cable Tips (10 pcs)
08783982	5.0 mm Cable Tips (10 pcs)
08783984	5.5 mm Cable Tips (10 pcs)
08783986	6.0 mm Cable Tips (10 pcs)
08783988	6.5 mm Cable Tips (10 pcs)
08783990	7.0 mm Cable Tips (10 pcs)
08783992	7.5 mm Cable Tips (10 pcs)
08783994	8.0 mm Cable Tips (10 pcs)
08783996	8.5 mm Cable Tips (10 pcs)
08783998	9.0 mm Cable Tips (10 pcs)



PRESSURE TEST KITS/ACCESSORIES



FIBER CABLE INSTALLATION

Micro Duct Pressure Test Kits

Use the Micro Duct Pressure Test Kit before setting up the Gulfstream™ 150/250/300 to pressure test, proof, and lubricate micro duct for optimum performance. For the cable blower to function properly, the microduct system must be able to withstand and hold 100 psi (7 bar). Air leaks will reduce the compressors' ability to maintain the required pressure for cable installation. The duct system must also be passable by a proofing ball of roughly 80% fill ratio so that there are no obstructions prohibiting the installation of fiber optic cable. Lubrication may also be desired to reduce the friction involved when installing fiber optic cable. Achieve maximum performance and installation distances by pressure testing, proofing, and lubricating the microduct with the Condux Micro Duct Pressure Test Kit.



Part Number	Description	QTY	U/M
08783302*	Standard Pressure Test Kit (includes all of the following)		
02291159	Tool Box	1	ea
08783304	Pressure Test Gun	1	ea
08230676	Lubricant, 8oz Bottle	1	ea
08783315	Micro Duct Cutter	1	ea
08783354	Micro Duct Cable Grip Test Kit	1	ea

*Must select appropriately sized Micro Duct Kit from any kit listed below

Part Number	Description	QTY	U/M
08783303	GS150 Pressure Test Kit (Includes all of the following)		
08783316	5mm Micro Duct Proof/Press Test Kit	1	ea
08783317	6mm Micro Duct Proof/Press Test Kit	1	ea
08783318	7mm Micro Duct Proof/Press Test Kit	1	ea
08783319	8mm Micro Duct Proof/Press Test Kit	1	ea
08783304	Pressure Test Gun	1	ea
08783315	Micro Duct Cutter	1	ea
02291159	Tool Box	1	ea
08230676	Lubricant, 8 oz Bottle	1	ea
08783354	Micro Duct Cable Grip Test Kit	1	ea

Part Number	Description	QTY	U/M
08783301	GS250/300 Pressure Test Kit (includes all of the following)		
08783319	8 mm Micro Duct Proof/Press Test Kit	1	ea
08783320	8.5 mm Micro Duct Proof/Press Test Kit	1	ea
08783315	Micro Duct Cutter	1	ea
08783318	7 mm Micro Duct Proof/Press Test Kit	1	ea
08783321	10 mm Micro Duct Proof/Press Test Kit	1	ea
08783324	14 mm Micro Duct Proof/Press Test Kit	1	ea
08783325	16 mm Micro Duct Proof/Press Test Kit	1	ea
08783322	12 mm Micro Duct Proof/Press Test Kit	1	ea
08783323	12.7 mm Micro Duct Proof/Press Test Kit	1	ea
08783326	18 mm Micro Duct Proof/Press Test Kit	1	ea
02291159	Tool Box	1	ea
08783354	Micro Duct Cable Grip Test Kit	1	ea
08783304	Pressure Test Gun	1	ea
08230676	Lubricant, 8 oz Bottle	1	ea

Micro Fiber Carrier Kit

Designed to attach to the central strength member (CSM) of the cable. The seals are sized to accommodate the proper ID duct size for maximization of the blowing distances and create an airtight seal in the duct.

Part Number	Description
08764090	Micro Fiber Carrier Kit



Why an Airtight Duct?

Duct integrity is essential for a successful cable blowing application. Leaks in the duct can lower pressure and greatly reduce installation distances. The duct system must be able to withstand and maintain 100 psi (7 bar) for the

cable blower to function properly. Duct integrity should always be tested before attempting cable installation with the cable blower. The duct can be tested with a pressure test kit available from Condux or with the cable blower itself. Either way, an airtight duct

system is an absolute necessity for cable blowing.

The main contributors to duct system leaks are the innerduct couplings. Condux recommends using one of the innerduct coupling methods shown on page 121.



INNERDUCT COUPLINGS

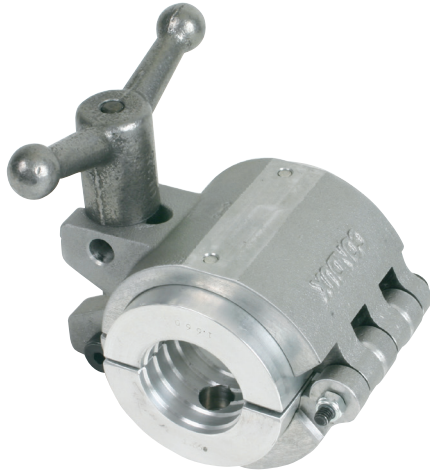

Speed Ball Split Coupling

Hinged aluminum split coupling for temporarily joining all types of innerduct during a cable blowing process.

Note: Inserts are sold separately.

Part Number	Description
08676844	Hinged Coupling Body

Inserts

Part Number	Duct Type	Mean Duct O.D.	
		(in)	(mm)
08676859	1" SDR 11 & 13.5	1.315	33
08676860	1 1/4" SDR 11 & 13.5	1.660	42
08676861	1 1/2" SDR 11 & 13.5	1.900	48
08676862	2" SDR 11 & 13.5	2.375	60
08676863	40 mm	1.575	40

*Inserts include rubber seal.

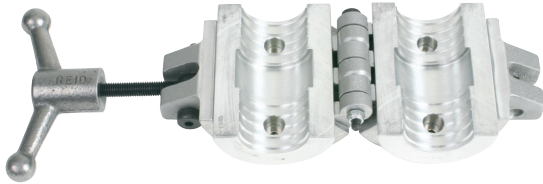

Replacement Seals

Part Number	Size
08676853	1" Seal
08676854	1 1/4" Seal
08676855	1 1/2" Seal
08676856	2" Seal
08676857	40 mm

*Quantities are 10 seals per pack.

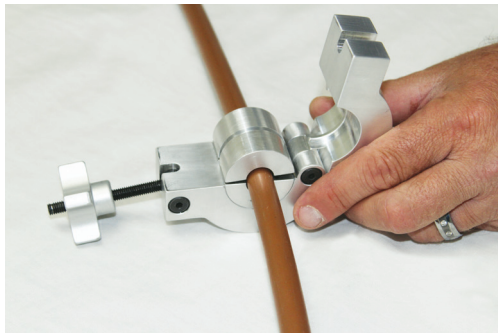

Reusable Micro Duct Couplers

The Condux® Reusable Micro Duct Coupler allows for the temporary joining of two pieces of microduct - essential when installing fiber optic cable.

These couplers are ideal for routing duct to the blowing machine or creating loops in downstream handholes. Unlike traditional plastic couplers, the hinged assembly can be removed mid-span and reused.

To be more cost effective, the innovative design utilizes a common body that accommodates a wide variety of inserts - making the Reusable Micro Duct Coupler the most versatile on the market.

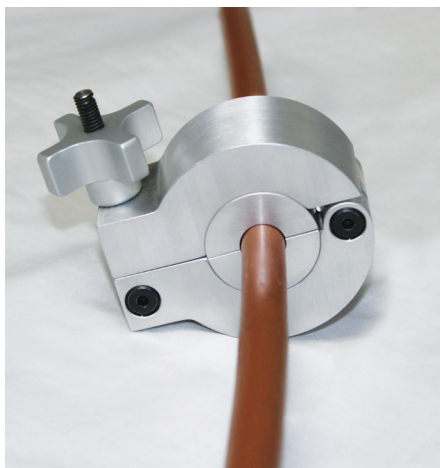

Part Number	Description
08783900	Body

08783910	Micro Duct Coupler Insert Set - 5.0 mm
08783911	Micro Duct Coupler Insert Set - 6.0 mm
08783912	Micro Duct Coupler Insert Set - 7.0 mm
08783913	Micro Duct Coupler Insert Set - 8.0 mm
08783914	Micro Duct Coupler Insert Set - 8.5 mm
08783915	Micro Duct Coupler Insert Set - 10.0 mm
08783916	Micro Duct Coupler Insert Set - 12.0 mm
08783917	Micro Duct Coupler Insert Set - 12.7 mm
08783918	Micro Duct Coupler Insert Set - 14.0 mm
08783919	Micro Duct Coupler Insert Set - 16.0 mm
08783920	Micro Duct Coupler Insert Set - 18.0 mm
08783921	Micro Duct Coupler Insert Set - 20.0 mm



CONDUX

Comfit Couplers

Comfit is a unique Hi-Tech coupler for HDPE cable ducts. Leak tested at 230 PSI and resistant to corrosion and most chemicals.

Comfit is designed in accordance with the special demands of the leading cable and duct manufacturers, as well as, top utility and contractors.

Comfit is excellent for both blowing and pulling applications.

Comfit has a compact profile reducing difficulties traditionally encountered in manholes, narrow trenches and plowing machines.

Comfit's push-fit method ensures fast and simple assembly and disassembly. Push the duct ends into the coupler for a locked and air sealed assembly. No special tools are needed.

Part Number	Nominal OD	Duct OD mm/in	Coupler OD mm/in	Max Tension PSI	Units per Box
08566109	¾"	26.6 mm/1.050"	43 mm/1.69"	580	144
08566110	1.0"	33.4 mm/1.315"	56 mm/2.20"	580	70
08566112	1¼"	42.2 mm/1.660"	72 mm/2.83"	1,130	56
08566115	1½"	48.3 mm/1.900"	82 mm/3.23"	1,470	36
08566120	2.0"	60.3 mm/2.375"	109 mm/4.29"	2,400	13
08566145	2" Clear Center	60.3 mm/2.375"	109 mm/4.29"	2,400	13
08566123	32 mm	32 mm	56 mm/2.20"	230	70
08566125	40 mm	40 mm	70 mm/2.76"	230	60
08566130	50 mm	50 mm	85 mm/3.35"	230	33



Max Pressure: 230 PSI

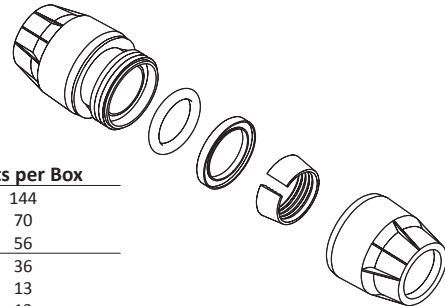

Microfit Couplers

Designed specifically for FTTx applications, the Condux® Microfit Couplers combine ease of use, chemical resistance and ability to accommodate the high pressures encountered when installing fiber with micro-blowing equipment.

The innovative transparent design ensures proper attachment by allowing the installer to visually verify that each end of the duct has been seated properly inside the coupler. Once connected, the air and water tight seal will hold pressure up to 232 PSI (16 Bar) in temperatures ranging from -4°F to 140°F (-20°C to 60°C).

These features incorporated into a push-on, no tools required design, make the Condux® Microfit Coupler an essential component of the professional installers toolbox.

Part Number	Description
08566310	Straight Connector - 5 mm Microfit
08566320	Endstop Connector - 5 mm Microfit
08566312	Straight Connector - 7 mm Microfit
08566322	Endstop Connector - 7 mm Microfit
08566335	Straight Connector - 8 mm Microfit
08566336	Endstop Connector - 8 mm Microfit
08566313	Straight Connector - 8.5 mm Microfit
08566323	Endstop Connector - 8.5 mm Microfit
08566315	Straight Connector - 10 mm Microfit
08566325	Endstop Connector - 10 mm Microfit
08566317	Straight Connector - 12 mm Microfit
08566327	Endstop Connector - 12 mm Microfit
08566337	Straight Connector - 12.7 mm Microfit
08566338	Endstop Connector - 12.7 mm Microfit
08566318	Straight Connector - 14 mm Microfit
08566328	Endstop Connector - 14 mm Microfit
08566319	Straight Connector - 16 mm Microfit
08566329	Endstop Connector - 16 mm Microfit
08566333	Straight Connector - 18 mm Microfit
08566334	Endstop Connector - 18 mm Microfit



Direct Bury Couplers

Designed specifically for FTTx applications, the Condux® Direct Bury Couplers feature a durable, shock resistant design that will hold up to virtually any terrain or soil condition.

The Direct Bury Coupler's metallic-free construction eliminates damage from oxidation or acidic soil conditions – guaranteeing it will maintain its seal over time. The translucent design ensures a proper connection by allowing the installer to visually verify that each end of the duct has been properly seated.

Once connected, the air and water tight seal will hold pressure up to 232 PSI (16 Bar) in temperatures ranging from -5°F to 113°F (-15°C to 45°C). These parameters will accommodate virtually any application situation encountered in the field - including the high pressures utilized when installing fiber with micro-blowing equipment.

These features incorporated into a push-on, no tools required design, make the Condux® Direct Bury Coupler an essential component of the professional installer's toolbox.



Part Number	Description
08566350	Direct Bury, Straight Connector - 7 mm
08566351	Direct Bury, End Stop - 7 mm
08566352	Direct Bury, Straight Connector - 8 mm
08566353	Direct Bury, End Stop - 8 mm
08566354	Direct Bury, Straight Connector - 10 mm
08566355	Direct Bury, End Stop - 10 mm
08566356	Direct Bury, Straight Connector - 12 mm
08566357	Direct Bury, End Stop - 12 mm
08566358	Direct Bury, Straight Connector - 14 mm
08566359	Direct Bury, End Stop - 14 mm
08566360	Direct Bury, Straight Connector - 16 mm
08566361	Direct Bury, End Stop - 16 mm
08566362	Direct Bury, Straight Connector - 20 mm
08566363	Direct Bury, End Stop - 20 mm





AIR COMPRESSORS

Compressed Air Cooler

Extreme heat can inhibit fiber optic cable installation and damage fiber optic cable and duct. When cable blowing, air is compressed and heat is generated. For example, air that enters a compressor at 100° F (37° C) exits the compressor at 350° F (176° C). At this temperature, fiber optic cable jacket and duct softening can occur. Heat problems can also occur if the duct run is exposed to direct sunlight. The Condux Compressed Air Cooler can help prevent heat damage to fiber optic cable and duct during cable blowing operations.

The Condux Compressed Air Cooler cools compressed air from a maximum temperature of 350° F (176° C), to within 20° F (11° C) of the ambient temperature. For example, if the ambient temperature is 100° F (37° C), air from the air compressor enters the air cooler at 350° F (176° C). That air will leave the cooler at approximately 120° F (49° C). Cooling the air reduces the chances of heat damage to the cable and duct. The Condux Compressed Air Cooler also removes moisture from the air. Water from humid air can dilute cable blowing lubricant and collect in the duct run.

Use of the Condux Compressed Air Cooler is recommended when ambient air temperatures reach 90° F (32° C) or more and/or the duct is exposed to direct sunlight.

Minimum ambient operating temperature: 35° F (1° C)

Maximum inlet operating temperature: 350° F (176° C)

Maximum operating pressure: 250 psi (17 bar)

Part Number	Description
08761700	Air Cooler
02291174	1 Quart Air Oil

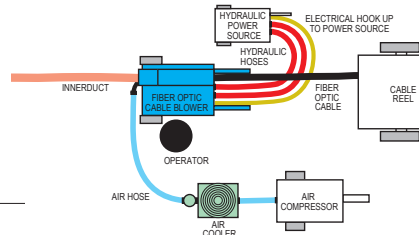

M17 Air Compressor with Air Cooler

The Mobilair™ M17 is a rugged and dependable unit that is perfect for a variety of applications. With a folding handle, oversized pneumatic tires, and compact design, this unit is easy to move around virtually any job site.

The M17 features Kaeser's power saving Sigma Profile™ airend. This efficient Kaeser design maintains steady pressure and puts out more air per hp, saving you gas. Driving these airends is a quiet but powerful Honda engine with modulation control which matches air output to the load demand. It has a simple electric starter with keyed ignition and an easy-to-read control panel.

The scratch, dent, and impact resistant rotomolded polyethylene shell takes a beating and still protects the unit. Inside, the compressors are protected by 4 micron inlet filters rated at 99.9% efficiency, allowing this unit to operate in virtually any construction environment. These units are a custom 35 cfm configuration and include an air cooler.



**recommended for the Condux Gulfstream™ 150, 250 and 300*

Part Number	Description
08785000	35 CFM @ 205 PSI (1 m3/min @ 14 bar) - Domestic Fittings
08785151	35 CFM @ 205 PSI (1 m3/min @ 14 bar) - International Fittings
08785050	3/8" 50 ft (9.5 mm 15 m) Hose with QDS (Domestic)
08785051	3/8" 50 ft (9.5 mm 15 m) Hose with QDS (International)

COMPRESSOR		GASOLINE ENGINE			PACKAGE		DIMENSIONS	
Model	Free Air Delivery at 205 psig (14.13 Bar)	Make	Power @ Full Load (hp)	Full Load Speed (rpm)	Off Load Running Speed (rpm)	Fuel Tank Capacity	Weight, dry	L x W x H
M17	35 cfm (1 m3/min)	Honda GX630	20.8 (15.51 KW)	3300	2200	5 gal (18.93 L)	445 lb. (201.85 kg)	42 in x 31 in x 31 in (108 cm x 80 cm x 78 cm)

Portable Hydraulic Power Packs

These portable power sources are matched perfectly to the power requirements of the Condux Fiber Optic Cable Puller and the Fiber Optic Cable Blower. See the chart below for specifications of each machine.



13 HP Power Pack

Part Number	Description
08675255	10 HP Hydraulic Power Pack, Electric
08675702	13 HP Variable Flow Power Pack
08675258	18 HP Hydraulic Power Pack, Gas
08675254	23 HP Hydraulic Power Pack, Diesel

*Battery and fluids included, packaged separately for shipping

SPECIFICATIONS																
Power Pack Size	10 HP Power Pack*				13 HP Power Pack (recommended)				18 HP Power Pack*				23 HP Power Pack*			
Part Number	08675255				08675702 08675702INTL				08675258				08675254			
Hyd. System	Open Center															
Frame Type	Two Wheel Mobile Unit				Two Wheel Mobile Unit				Two Wheeled Mobile Unit				Two Wheel Mobile Unit			
Length	27.5" (698 mm)				26.5" (673 mm)				39" (991 mm)				39.0" (990 mm)			
Width	24.5" (622.3 mm)				20" (508 mm)				29" (737 mm)				28.8" (731 mm)			
Height	31.5" (800.1 mm)				27.5" (698 mm)				32" (813 mm)				36.5" (927 mm)			
Weight (Dry)	200 lbs (90.72 kg)				143 lbs (65 kg)				233 lbs (106 kg)				520 lbs (236 kg)			
Filtration	10 Micron Return Line Canister				10 Micron Return Line Canister				10 Micron Return Line Canister				10 Micron Return Line Canister			
Oil Cooler	Air to Oil with Ind. Fan				Air to Oil				Air to Oil				Air to Oil			
Engine	Baldor Electric 10 HP 220V 3 Phase Motor				Gas 13 HP Honda GX390				Gas 18 HP				Diesel 23 HP Kohler Tier 4 Compliant			
Fuel					1.6 gallons/6.4 liters				5 gallons/18.9 liters				5 gallons/18.9 liters			
Hydraulic Oil (Useable)	4 gallons/15.1 liters				5 gallons/18.9 liters				5.3 gallons/20.1 liters				4 gallons/15.1 liters			
Hydraulic Rated Flow	GPM @ PSI		LPM @ BAR		GPM @ PSI		LPM @ BAR		GPM @ PSI		LPM @ BAR		GPM @ PSI		LPM @ BAR	
	8.8	0	33.3	0	6.8	0	25.8	0	11	0	42	0	12	0	45.4	0
	8.0	2,000	30.2	138	5.9	1,800	22.4	138	10	2,000	38	138	12	2,000	45.4	138
					8.8	0	33.3	0								
				8.0	2000	30.2	138									
Hydraulic Relief Valve Pressure	2,100 PSI (145 BAR)				2,150 PSI (148 BAR)				2,150 PSI (148 BAR)				2,150 PSI (148 BAR)			

*Special Order

Hydraulic Power Pack Accessories

Part Number	Description
08675858	Hydraulic Hose Kit, 20' (6 m) Hose with Couplings
08780384	Hydraulic Hose with flow control manifold (GS400)
02260000	Hydraulic Coupling, Female Flat Face Faster 2FFN38-12NPT-F / Bruning FF371-8FP
02260100	Hydraulic Coupling, Male Flat Face Faster 2FFN38-12NPT-M / Bruning FF372-8FP
02260200	Dust Cap, Male Coupling
02260201	Dust Cap, Female Coupling
02286416	Power cord assembly extension, 2-pin straight, 20' (6 m)
08761248	Power cord with cigarette adapter



Dust Caps

Couplings



FIBER OPTIC CABLE PULLER

Fiber Optic Cable Puller

The Fiber Optic Cable Puller from Condux sets new standards for safe, accurate pulling of fiber optic cables. Only the Condux puller can offer load cell torque input for the most accurate tension measuring available. Unlike most hydraulic measuring systems, this system is not affected by changes in oil temperature, component age and power source. That means the Condux Fiber Optic Cable Puller does not need to be recalibrated under different weather conditions.

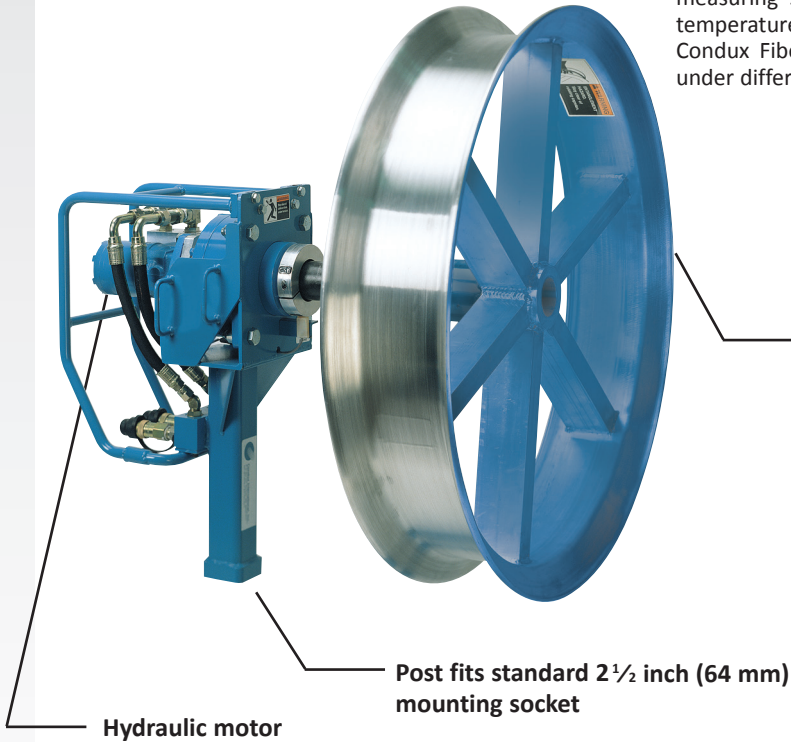

Capstan Sizes Available:
12 inch (305 mm)
30 inch (762 mm)
42 inch (1,067 mm)
50 inch (1,270 mm)
62 inch (1,575 mm)



Standard Features

These pullers consist of a hydraulic motor and variable speed foot control. All pullers are calibrated for a maximum pull tension of 600 lbs on a 30" capstan; maximum pull tension can be adjusted using the manually adjustable pressure relief valve.

Optional Features

The Condux Fiber Optic Cable Puller features an optional electronic tension control system with adjustable digital load limits and a load cell tension measuring device with a paperless recorder and trend display, compact flash drive with 64MB flash card and USB interface (see page 126-127).

WARNING: The Fiber Optic Cable Puller is not to be used as a hoist or for lifting, supporting or transporting people or loads.



FIBER OPTIC CABLE PULLER



Easy to set up, Safe to use

Condux Fiber Optic Cable Pullers set up easily at a variety of jobsite layouts. Components are modular, adding to versatility and operator safety.

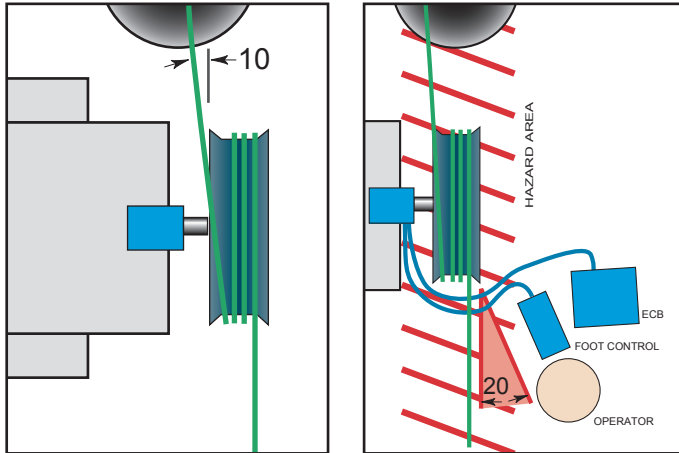

Variable Speed Foot Control

Like the accelerator pedal in your car or truck, the Variable Speed Foot Control allows the operator to easily manage the speed of the pull.

Recommended Hydraulic Power Source Specifications	
Pressure	0-2,000 psi (0-138 bar)
Flow	0-8 gpm (0-30 lpm)
Peak Power	13 HP (9.7 kW)

Fiber Optic Cable Puller Performance										
Capstan Diameter	12 in (305 mm)		30 in (762 mm)		42 in (1,067 mm)		50 in (1,270 mm)		62 in (1,575 mm)	
Max. Pulling Force	lbs	N	lbs	N	lbs	N	lbs	N	lbs	N
		2,000	8,900	900	4,000	600	2,670	540	2,400	430
Max. Pulling Speed*	ft/min	m/min	ft/min	m/min	ft/min	m/min	ft/min	m/min	ft/min	m/min
	98	30	240	74	340	100	410	120	500	150

* At no load and input of 8 gpm (30 lpm)

FIBER CABLE INSTALLATION





FIBER OPTIC CABLE PULLER



Electronic Control Box

Optional Electronic Control System

Features large LED Display and Paperless Recorder with trend display. Paperless Recorder includes: Trend Display, CompactFlash™ card slot with 256MB Flash Card, and USB interface. A programmable overload set point has both an audible and visual indication of an overload condition. The Electronic Control Box also has the capability to disengage the cable puller if an overload occurs.

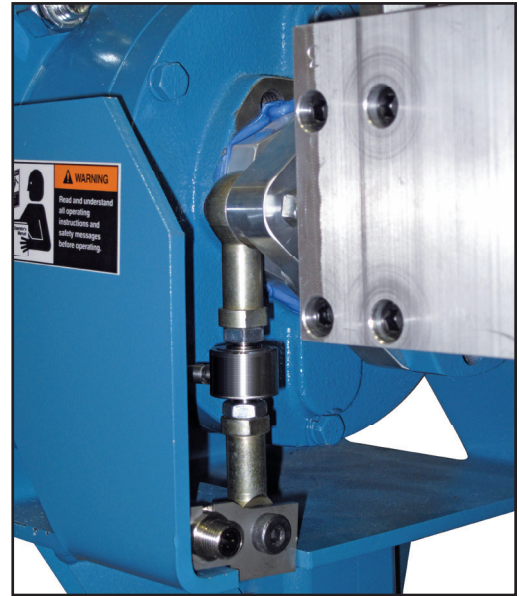

Electronic Controls: Easy, Informational, Durable

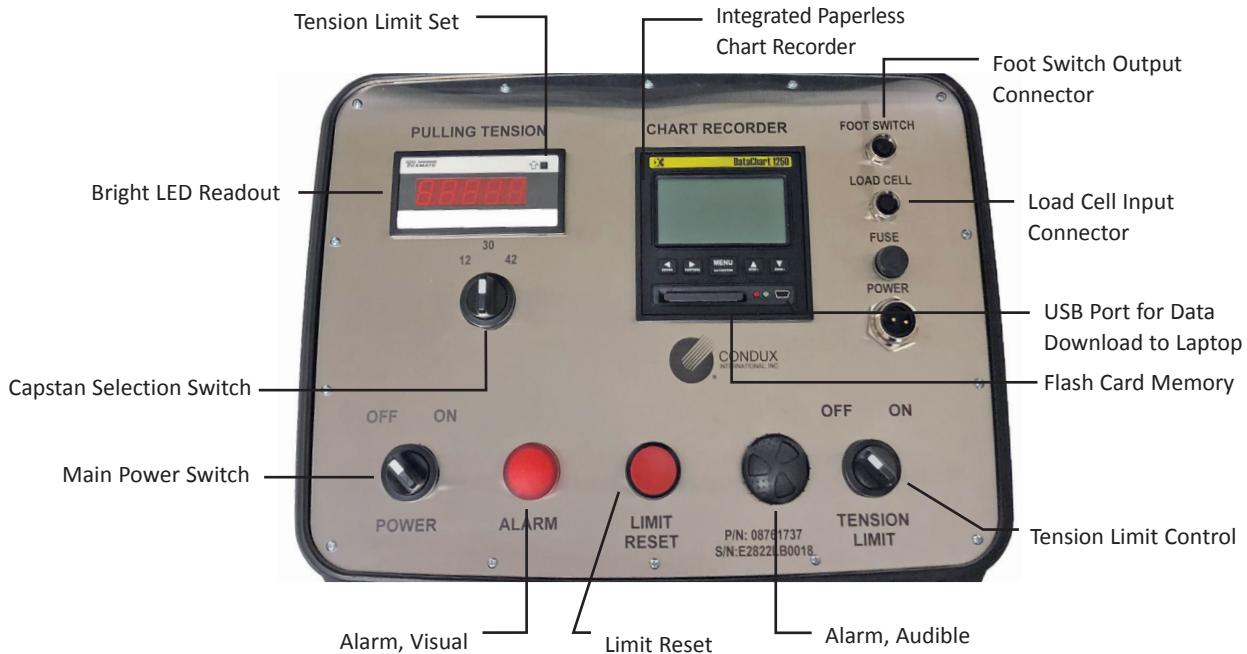



FIBER OPTIC CABLE PULLER PACKAGES



FIBER CABLE INSTALLATION

Fiber Optic Cable Pulling Packages

A complete fiber optic cable pulling jobsite setup requires a Fiber Optic Cable Puller (with foot control and hoses), a capstan, a puller mount, and a hydraulic power source. These components are purchased separately; the options for pullers, capstans, and mounts are listed below. Condux recommends a hydraulic power source capable of up to 8 gpm (30 lpm) and 2000 psi (138 bar) for use with the Fiber Optic Cable Puller (see page 123 for hydraulic power pack listings).



Fiber Optic Cable Pullers

Base Part Number	Description
08690002	Fiber Optic Puller - Includes Puller, Foot Control and Hoses.

Base Part Number	Description
08690056	Fiber Optic Puller with ECB - Includes Puller, Foot Control, Hoses, and Electronic Control Box.

Capstans

For a standard 2⁷/₁₆" diameter bayonet style shaft.

Part Number	Diameter		Flat Width		Max. Cable O.D.		Load Rating	
	(in)	(mm)	(in)	(mm)	(in)	(mm)	(lbs)	(kN)
08675213*	12	305	9	229	-	-	2,000	8.9
08675230	30	762	4	102	0.75	19	1,000	4.4
08675430	30	762	8	203	0.75	19	600	2.7
08675436	42	1,067	8	203	1.05	27	600	2.7
08675220	50	1,270	8	203	1.25	32	600	2.7
08675275	62	1,575	8	203	1.55	39	600	2.7

* Not to be used for fiber optic cable. Intended for pulling innerduct, power, telephone or coaxial cables.

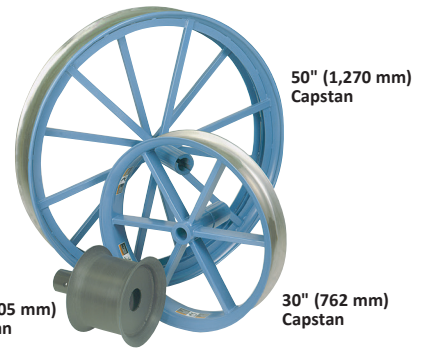

Fiber Optic Cable Puller Mounts

Remote Mounting Stand

Allows positioning of the cable puller well away from the power source. Easy to set up, the unit is both sturdy and compact.

Part Number	Description
08675115	Remote Mounting Stand
08675282	Wide Remote Mounting Stand (required for 62" capstan)

Fiber Optic Cable Puller Hitch Mount

The Hitch Mount attaches directly into a typical 2" (51 mm) square Reese-type receiver. An adjustable jack is included for added stability and height adjustment. Pulling loads must not exceed 800 lbs. (3,559 N).

Part Number	Description
08675908	Fiber Optic Cable Puller Hitch Mount
08675930	Adjustable Fiber Optic Cable Puller Hitch Mount 22.5°

Pole Mounting Frame

A special plug drives into wood poles for added stability. Includes all mounting hardware.

Part Number	Description
08676000	Pole Mounting Frame and hardware

Mounting Sockets

Part Number	Description
02260801	Floor Socket Mount, cast
08675130	Base Mount
08675138	Side Mount

Remote Mounting Stand



Fiber Optic Puller Hitch Mount

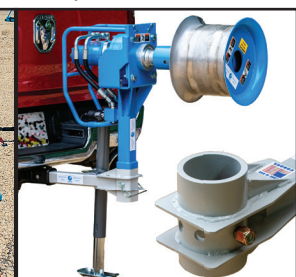

Adjustable Hitch Mount 22.5°



Pole Mounting Frame



Mounting Sockets
1-Floor Socket Mount
2-Base Mount
3-Side Mount



FIBER OPTIC CABLE PULLER ACCESSORIES



Fiber Optic Cable Puller Package Upgrade Kit

Part Number	Description
08675920	Electronic Control Box Kit - Includes Chart Recorder and Load Cell

ECB Replacement Parts

Part Number	Description
02286416	2 Pin Extension Cord
02290108	Cord, Footswitch
08677375	Cord, Load Cell
08761248	Plug, Lighter Cord



Calibration Dynamometer

The Condux Fiber Optic Cable Puller is calibrated at the factory prior to shipment. The Calibration Dynamometer is used to check that the puller's calibration has not changed, especially if the relief valve has been adjusted in the field. On cable puller models equipped with an Electronic Control Box, the Calibration Dynamometer simply verifies the readings. Other load capacities available.

Number	Description
02261000	1,000 lb (454 kg) Calibration Dynamometer
02261040	4,000 lb (1814 kg) Calibration Dynamometer



Fiber Optic Mid-Assist

The Fiber Optic Mid-Assist is an ideal mid-point cable pulling solution. Portable components set up quickly. Fits in standard 2 1/2" (64 mm) square mounting socket. Capstan and Remote Mounting Stand sold separately (see page 127).

Number	Description
08675975	Remote Mount Mid-Assist



CONDUX

SLIP CLUTCH CAPSTAN



Slip Clutch Capstan

Slip Clutch Capstans from Condux are designed to mount directly on a bayonet style winch drive shaft. A factory preset torque limiter prevents pulling tensions from exceeding 600 pounds (2,670 N) \pm 10% (60 lbs or 267 N). If the preset load is reached, the capstan will "slip" and discontinue rotating.

High strength aluminum and steel construction ensures product durability and cable protection.

The capstan is designed for use with a 2 $\frac{7}{16}$ " (62 mm) diameter, AT&T specification bayonet style power take-off (PTO) shaft.

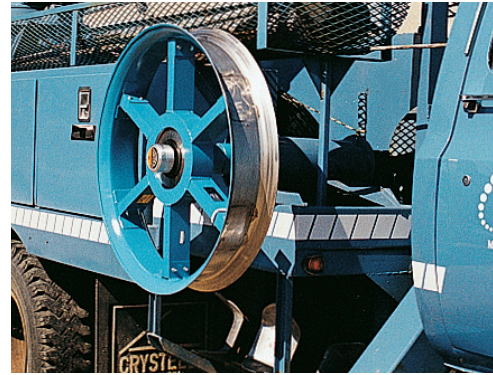

Part Number	Diameter		Flat Width		Max. Cable O.D.		Rating	
	(in)	(mm)	(in)	(mm)	(in)	(mm)	(lbs)	(N)
08760030-06	30	762	4	102	.75	19	600	2670
08760040-06	42	1,067	8	203	1.05	26.7	600	2670
08760050-06	50	1,270	8	203	1.25	32.5	600	2670

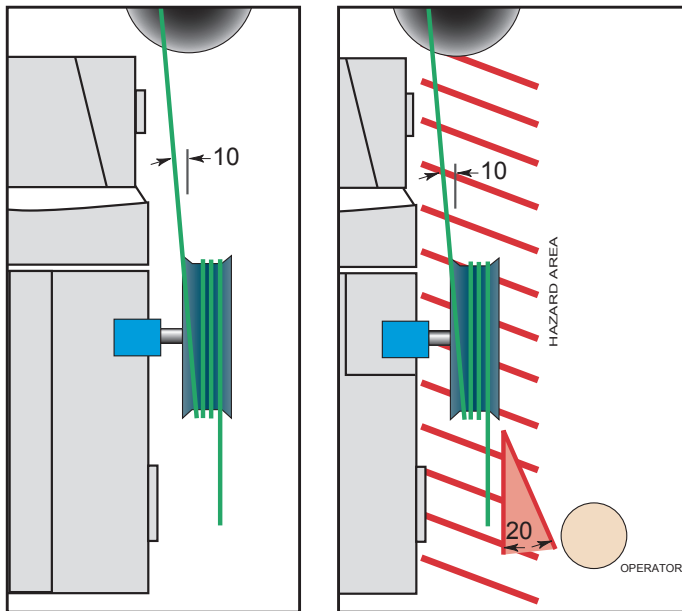

FIBER CABLE INSTALLATION





FIBER OPTIC CABLE PULLER TRAILER

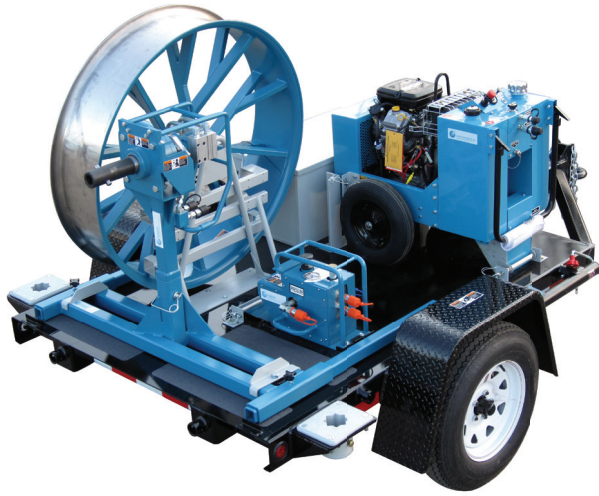

Open Style Fiber Optic Cable Puller Trailer

Access job sites with ease using the Condux Open Style Fiber Optic Cable Puller Trailer. The open style has advantages in portability, accessibility and cost.

On the job, gain easy access to all components with the open face design. Small items can be stowed in a lockable storage compartment. Leveling and stabilizing hardware is included. The Open Face Fiber Optic Cable Puller Trailer comes standard with built-in cable puller mounts on the left and right rear corners.

Options include a choice of two Condux Fiber Optic Cable Puller packages, choice of four capstans, a 13 HP (9.7 kW) Power Pack and a Remote Mounting Stand. The trailer bed is designed to accommodate standard and optional equipment with built-in mounting systems for secure travel.

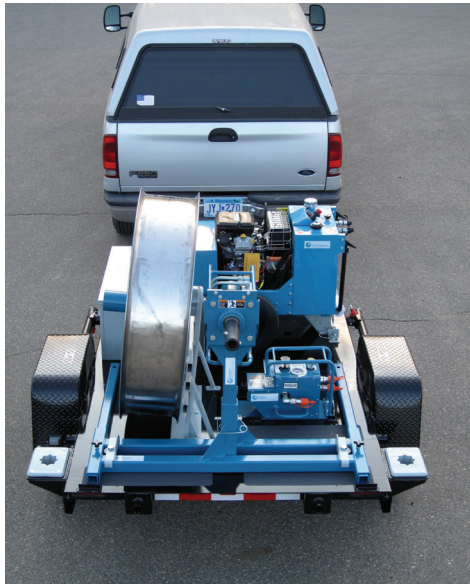

Build your own Open Style Fiber Optic Cable Puller Trailer Kit

Use the **Base Part Number** shown below and also choose accessory options by part number when placing your order. All items are priced individually.

Base Part Number	Description
08675675	Open Style Fiber Optic Cable Pulling Trailer <small>(Includes: Trailer Flat Assembly, Wheel Chocks and Tool Box) *Some assembly required</small>

Choose one selection from each category:

1 **Fiber Optic Cable Puller Options:**
(Includes Foot Control and Hoses)

Part Number	Description
08690001	Fiber Optic Cable Puller without Electronics
08690055	Fiber Optic Cable Puller with Electronic Control Box and Paperless Chart Recorder

2 **Capstan Options:**

Part Number	Description
08675230	30" (762 mm) Capstan; 4" (102 mm) wide
08675430	30" (762 mm) Capstan; 8" (203 mm) wide
08675436	42" (1,067 mm) Capstan; 8" (203 mm) wide
08675220	50" (1,270 mm) Capstan; 8" (203 mm) wide

3 **Power Pack Option:**

Part Number	Description
08675702	13 HP (9.7 kW) Power Pack, Gas

4 **Stand Option:**

Part Number	Description
08675115	Remote Mounting Stand

Complete Fiber Optic Puller Trailer Packages

Packages include puller, capstan, remote mounting stand, and hydraulic power pack assembled on trailer.

Part Number	Description
08675740	30x4 Fiber Optic Puller/Trailer/Capstan Pkg
08675742	30x8 Fiber Optic Puller/Trailer/Capstan Pkg
08675744	42x8 Fiber Optic Puller/Trailer/Capstan Pkg
08675746	50x8 Fiber Optic Puller/Trailer/Capstan Pkg





FIBER OPTIC CABLE PULLER TRAILER

Accessible storage; all components are easy to see and use

4 Capstan sizes available

Trailer weighs 800 lbs. (363 kg) (without options)

Remote Mounting Stand (detachable)

2 1/2 inch (64 mm) square mounting socket for use with any Fiber Optic Cable Puller

13 hp (9.7 kW) variable flow power pack



Power Supply	
Engine	HP Honda GX390
Horsepower	13hp @ 3600 rpm 11.9 kW @ 3600 rpm
Starting	Electric
Fuel	Unleaded Gas, 85 Octane Min, 10% or less ethanol blend
Fuel Capacity	1.6 gallons (6.4 L)
Speed Control	Variable

Hydraulics	
Capacity	8.0 gpm @ 2,000 psi (30.2 lpm @ 138 bar)
Reservoir	5.0 gallons (18.9 L)
Filtration	10 micron return line canister type
Hydraulic Oil Requirements	petro based, anti-wear, high viscosities over 140
Hydraulic Relief Valve Pressure	2,150 psi (148.3 bar)

Stand Alone Trailer Specifications	
Weight	800 lbs (363 kg)
Axle	3,500 lbs (1,590 kg) Type II
Tire	P205/75R14 Steel Belted Radials
Rims	14" x 6" (356 mm x 152 mm)
Track	60" (1,254 mm)
Overall Width	80" (2,032 mm)
Overall Height	48" (1,219 mm)
Hitch	3" (76 mm) Lunette Eye
Lighting	7 Pin Connector
Electronics	12 VDC

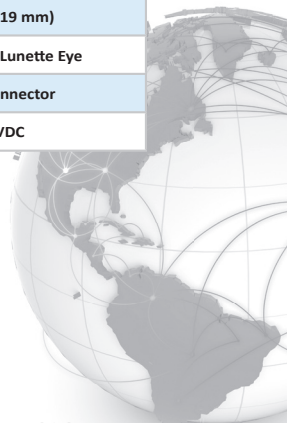



FIBER OPTIC JAMB SKIDS AND CABLE GUIDES

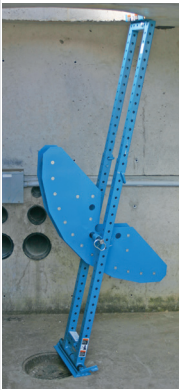

Fiber Optic Jamb Skid

The Condux Fiber Optic Jamb Skid is a device for supporting fiber optic sheaves or quadrant blocks inside a manhole to pull fiber optic cable into underground conduit.

Constructed of steel tubing, the Fiber Optic Jamb Skid is strong, 1,000 lbs. (4,480 N) load rated, and lightweight, can be installed by one person.

Part Number	Description	Manhole Height Range	
		(in)	(mm)
08097100	46" (1,168 mm) Base Section with locking pins	49-80	1,244-2,032
08097200	43" (1,092 mm) Extension		



Fiber Optic Quadrant Block

Protects fiber optic cable during installation. Pulling radius of 26" (660 mm); 13 aluminum rollers on bronze bearings allow cable to make a gradual 90° turn for easy pulling through manhole opening. Lightweight, corrosion-resistant aluminum side plates. Can be lowered into any manhole opening and chained in place for good alignment or used as a cable guide at street level. 2,600 lbs. (11,565 N) cable tension load capacity. 1½" (38 mm) maximum cable diameter (consult cable manufacturer for minimum bend radius). Support bar sold separately (see page 96). Replacement Sheaves available.

Part Number	Description
08539350	Quadrant Block
08539308	Replacement Sheave

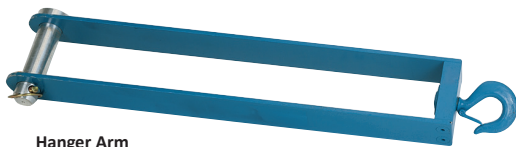

Hanger Arm

Hanger Arms

Allows the hanging of the Fiber Optic Quadrant Block in a manhole for more flexible positioning.

Part Number	Description
08539320	Hanger Arm



Fiber Optic Hanger Block

Five aluminum rollers on bronze bearings allow cable to make a gradual 90° turn for easy pulling through manhole opening. Has a pulling radius of 12" (305 mm). Two non-metallic "keeper" rollers to hold the cable in place during the pull. Lightweight corrosion resistant aluminum side plates. Can be suspended in the manhole or hung on an overhead pole for easy pulls. ¾" (19 mm) maximum cable diameter (consult cable manufacturer for minimum bend radius). 800 lbs. (3,558 N) cable tension load capacity. Replacement Sheaves available.

Part Number	Description
08539550	Hanger Block
08539308	Replacement Sheave



FIBER OPTIC CABLE GUIDES



FIBER CABLE INSTALLATION

Fiber Optic Sheave Mount

Fiber Optic Sheave Mounts are an ideal solution to mid-point cable pulling situations. The adjustable sheave mount allows pinpoint adjustment from horizontal to vertical. Portable components set up quickly and adjust from job to job, offering maximum versatility with minimum equipment. Uses a standard 2½" (64 mm) square mounting post for use with FO Cable Puller Remote Mounting Stand or Mounting Sockets (see page 127).

Fiber Optic Sheave Mount Components

Part Number	Description
08637900	Adjustable Sheave Mounting Head (includes sheave mounting shaft & pins)
08637909	18" (457 mm) Center Tube Mount
08637910	32" (812 mm) Center Tube Mount
08637911	48" (1,220 mm) Center Tube Mount
08637912	Fiber Optic Sheave Arm Assembly
08637743	Fiber Optic Aluminum Hanger Sheave 3" x 24" (76 x 610 mm)
08675115	Fiber Optic Puller Remote Mounting Stand Assembly (See page 127 for details)

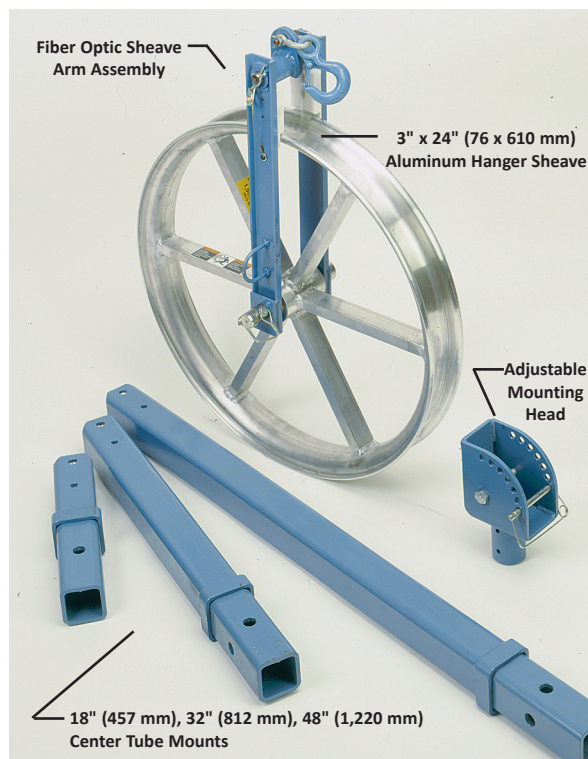

Package 1

Fiber Optic Sheave Mount Packages

Part Number	Description
08637930	Adjustable Fiber Optic Sheave Mount, Pkg 1 Includes mounting head, all 3 mounting tubes, sheave and sheave arm assembly.
08637940	Adjustable Fiber Optic Sheave Mount, Pkg 2 Includes everything in Pkg 1 except the sheave arm assembly.

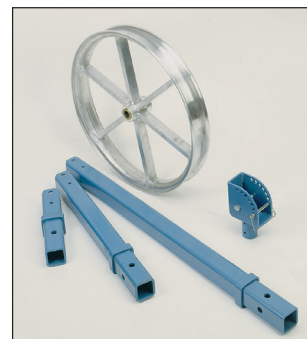

Package 2

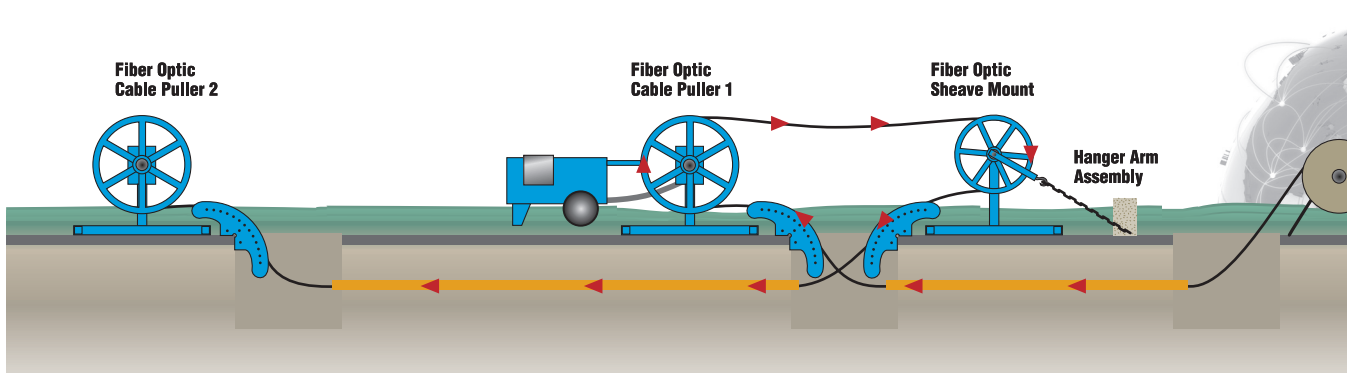



UHFC (ULTRA-HIGH FIBER COUNT) CABLE GUIDES



32 Inch Quad Block

Our latest Fiber Optic Quad Block protects high density fiber count cable during installation. Replacing traditional aluminum rollers with three sections of high density nylon provides over 45 contact inches of cable support - significantly reducing the occurrence of micro bends during installation. The 32" (81 cm) pulling radius allows cables up to 1.60" (4.1 cm) to make a gradual 90° turn for stress free pulling. Lightweight, corrosion-resistant aluminum side plates reduce the weight to a very manageable 37 lb (16.8 kg).

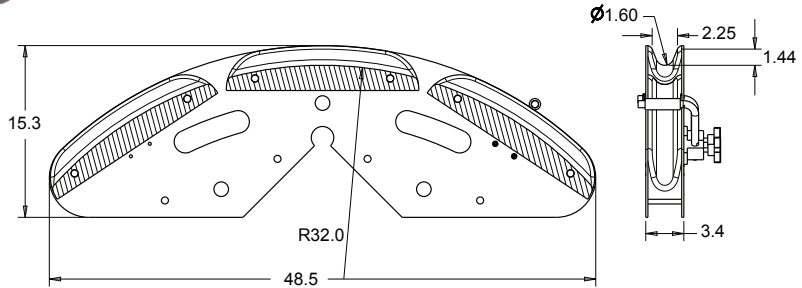

Part Number	Description	Max Fiber Cable Diameter*	Rated Load	Length	Height	Width	Weight
08539715	32" Fiber Quad Block	1.6 in/4.1 cm	600 lb/272 kg	48.5 in/123.2 cm	15.3 in/38.9 cm	3.4 in/8.6 cm	37 lb/16.8 kg

* Always refer to mfg's specifications for minimum bend radius under tension during installation.



36 Inch and 45 Inch Split Sheaves for Fiber Optic Cable

These larger diameter split sheaves are designed for safe installation of high fiber count cables in multiple applications. High fiber count cables require larger diameter service equipment so to not violate the minimum bend radius of the cable. Split sheaves can be easily carried below the surface in two pieces and then quickly assembled making them among the most versatile on the market and an ideal solution for mid-point installation situations. Available with or without hanger brackets adds even more flexibility to the installation process.

Features:

- Deep race races that protect and cradle the cable on the sheave
- Meets minimum bend radius requirements of most fiber optic cables
- Alignment markings and 4 tethered thumb screws make reassembly fast
- Self-lubricating bearings
- Cable retention guide pins

Part Number	Description	Max Fiber Cable Diameter	Sheave Land Width	Sheave Diameter	Weight	Rated Load
08637500	36" Split Sheave	0.9 in/2.3 cm	3.3 in/8.3 cm	36 in/91.4 cm	31 lb/14 kg	600 lb/272 kg
08637501	36" Split Sheave w/ Hanger Brackets	0.9 in/2.3 cm	3.3 in/8.3 cm	36 in/91.4 cm	59 lb/27 kg	600 lb/272 kg
08637505	45" Split Sheave	1.125 in/2.9 cm	3.3 in/8.3 cm	45 in/114.3 cm	38 lb/17 kg	600 lb/272 kg
08637506	45" Split Sheave w/ Hanger Brackets	1.125 in/2.9 cm	3.3 in/8.3 cm	45 in/114.3 cm	69 lb/31 kg	600 lb/272 kg

* Always refer to mfg's specifications for minimum bend radius under tension during installation.



FIBER OPTIC CABLE GUIDES & LUBRICANT

Overhead Fiber Optic Cable Sheave

Specially designed for guiding fiber optic or CATV cable safely and efficiently, Condux Cable Sheaves feature an innovative hanger arm that eliminates the possibility of cable coming off the sheave or binding against the support arm. With the removal of a pin, the hanger arm separates and allows cable to be slipped in easily, even at midpoints.

24-inch (610 mm) sheave diameter allows for a gentle cable arc. Aluminum sheave construction means durability with less weight. Maximum capacity is 1,500 lbs. (6,672 N). Replacement Sheaves available.

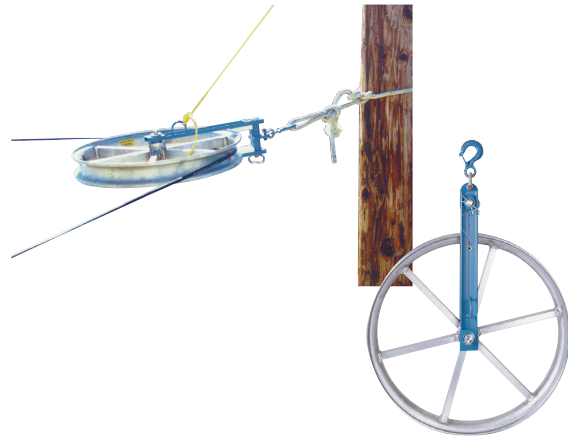

Part Number	Description
08637825	24" (610 mm) Overhead Fiber Optic Cable Sheave
08637743	Replacement Sheave

Underground Fiber Optic Cable Sheave

The Underground Fiber Optic Sheave has all the features of the Overhead Sheave (above) but with an additional second arm for convenient tie-off. Replacement Sheaves available.



Part Number	Description
08637800	Underground Fiber Optic Cable Sheave NOTE: Sheave Size 24" O.D.
08637806	Replacement Tie-Off Arm
08637743	Replacement Sheave

Polywater® Lubricant F

Polywater® Lubricant F is a high performance, pourable liquid recommended for long and difficult fiber optic cable pulls. It is slow drying and leaves a lubricating film after its water base evaporates. Polywater F does not stress crack low density polyethylene and is compatible with all types of cable jackets.



Part Number	Description	Min. Order Qty.
08230100	1 Quart (.9 liter) Squeeze Bottle	12 Bottles
08230101	1 Gallon (3.8 liter) Jug	4 Jugs
08230104	2½ Gallon (9.5 liter) Jug	2 Jugs
08230105	5 Gallon (19 liter) Pourable Pail	1 Pail
08230155	55 Gallon (208 liter) Drum	1 Drum

Polywater® Lubricant WF

Lubricant WF is a non-freezing form of the standard Lubricant F.

Part Number	Description	Min. Order Qty.
08230201	1 Gallon (3.8 liter) Jug	4 Jugs
08230204	2½ Gallon (9.5 liter) Jug	2 Jugs
08230205	5 Gallon (19 liter) Pourable Pail	1 Pail

For Cable Blowing Lubricants, see page 118.





CABLE CUTTERS



TurboSlitter™

The TurboSlitter™ from Condux can easily split HDPE pipe with wall thicknesses ranging from 0.097 to 0.216 inches! The cordless drill attachment quickly adjusts to fit almost any cordless drill. Save time and effort on the job with the TurboSlitter from Condux. Cordless drill not included.

Part No.	Description
08010220	TurboSlitter-Cordless Drill Attachment <ul style="list-style-type: none"> • Drill Attachment • Lightweight shear head for easy one-hand control • Telescoping clamp fits large or small drill housing
08010203	Replacement Blades



08010220



Shown assembled on drill with case.

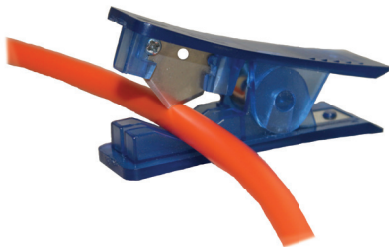

Microduct Cutter

The Condux Microduct Cutter is capable of cutting duct ranging from 3 mm to 18 mm. This cutter is designed specifically to ensure a quick cut, leaving your duct un-crushed and kink free.

Part Number	Description
08783315	Micro Duct Cutter

Telephone Cable Cutters

Lightweight shear-type cable cutter for copper pair telephone cable. Not intended for cutting steel or ACSR.



Part No.	Description	Max Dia.	
		(in)	(mm)
08090300	30" (762 mm) steel handles	3.37	86



CABLE CUTTERS



OTHER PRODUCTS

Innerduct Slitter

Mechanical Innerduct Slitter is designed to reduce the effort required to longitudinally slit long sections of both High Density Polyethylene (HDPE) and Medium Density Polyethylene (MDPE) innerduct and conduit that have an outside diameter ranging from 1¼" (32 mm) to 2" (51 mm).

Each kit comes with the following:

- Slitter
- Double-sided replacement blade
- Blue leather storage bag
- Leather blade protector
- Allen key that fits all screws
- Set of instructions

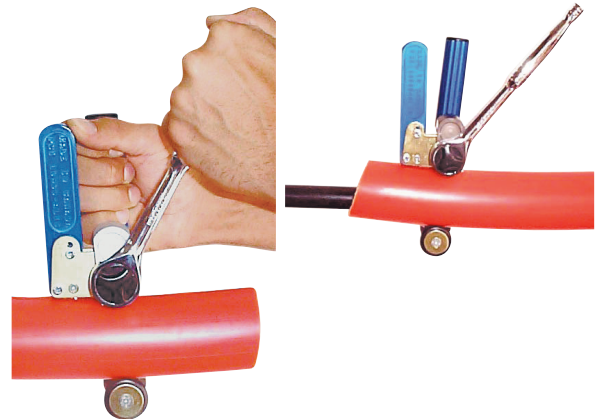

Part Number	Description
08012925	Innerduct Slitter
08013101	Replacement Blade

Innerduct Slitter

The Innerduct Slitter is designed for fast, safe cutting of innerducts from 1" (25 mm) to 2" (51 mm).

Part Number	Description
08013100	Innerduct Slitter
08013101	Replacement Blade



PVC & Polyethylene Cutter

Razor sharp cutting blade makes a fast, clean, burr-free cut in PVC and polyethylene. Ratcheting handle provides for sure, steady cutting action. Reduces cutting and preparation time.

Part Number	Description
08948050	Small diameter—up to 1¼" (32 mm) conduit with 1½" (38 mm) O.D.
08948074	Large diameter—up to 2" (51 mm) conduit with 2¾" (60 mm) O.D.
08948075	Replacement Blade for Large Diameter Cutter



Cable Bender

Bends power cable up to 750 kcmil with a 1¼" (32 mm) maximum cable diameter.

Part Number	Description
08090000	Cable Bender





CABLE CUTTERS

Utility Cable Cutters

Lightweight shear-type cable cutter for copper and aluminum cable. Not intended for cutting steel or ACSR.

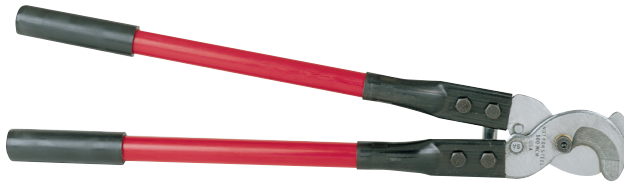

Part No.	Description	Cuts (max. kcmil)		Max Dia.	
		Copper/Alum.	(in)	(in)	(mm)
08012300	13" (330 mm) steel handles	350/350	.90	23	
08012400	17" (432 mm) 600 V fiberglass handles	500/750	1.03	26	
08012500	26" (660 mm) 600 V fiberglass handles	1000/1200	1.40	36	

Ratcheting Cable Cutters

Easy one or two handed cutting for copper and aluminum power cables. Specially designed tempered blades combine with positive ratcheting action to cut through most cable. A release lever lets you break free from the load whenever necessary. Hardened steel ratchet teeth resist breakage and will last at least three times longer than inferior ratcheting cutters. Lightweight and portable.



Condux also offers replacement blades for this cable cutter.

Part No.	Description	Cuts (max. kcmil)		Max Dia.	
		Copper/Alum.	(in)	(in)	(mm)
08014000	Cutter	600-750	1 3/4	44	
08014001	Replacement blade				

Cable Stripper/Slitter

Condux offers two sizes of the Stripper/Slitter for easy and rapid preparation of round cables from .18 (5 mm) up to 1.42 inch (36 mm) in diameter and 8 AWG up to 500 kcmil. They feature a spring-loaded cable support arm with a beveled leading edge that assists with insulation removal. The blade swivels to facilitate circular, longitudinal and spiral cuts.



Part No.	Description	Cutting Depth		Max Dia.	
		(in)	(mm)	(in)	(mm)
08013000	Small Diameter Stripper/Slitter	.118	3	.18-1.00	5-25
08013050	Large Diameter Stripper/Slitter	.177	4.5	.98-1.42	25-36
08013001	Replacement Blade (fits both sizes)				



MANHOLE GUARD RAILS, SHIELDS & HOOKS



OTHER PRODUCTS

Manhole Guard Rail

Furnished with two steel chains and wing bow locking brace to assure sturdy protection. Painted safety yellow. Freestanding.

Part Number	Description	A Height		B Length		C Width		Weight	
		(in)	(mm)	(in)	(mm)	(in)	(mm)	(lbs)	(N)
08043300	Manhole Guard Rail	42	1066	32	812	32.25	819	32	14.5
08043301	Manhole Guard Rail with Shield Clamps	42	1066	32	812	32.25	819	32	14.5

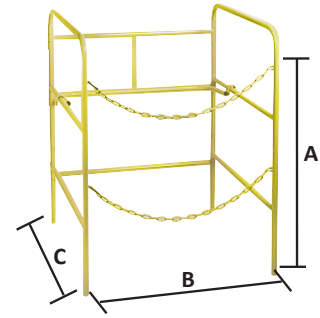

High Impact Polymer Manhole Shield

Constructed of rugged lightweight polyethylene with bright yellow material that resists fading. Will fit 27" (686 mm), 30" (762 mm) and 32" (813 mm) diameter manholes with an inflatable seal that ensures a watertight seal. Designed with four outrigger support gussets that stabilize the shield and is 12" tall to keep water and mud out of the manhole as you work. Can be used with Condux guardrail.



Part Number	Description
08043400	Manhole Shield

Inflate seal until manhole shield fits snugly in the manhole ring. Over-inflating will cause the shield to pop out of the ring.

Manhole Cover Lifting Hooks

Part Number	Length	
	(in)	(mm)
08023001	18	457
08023000	24	610
08023002	36	914
08023003*	36	914
08023005**	30	762

*36" long, 90° hook.
**30" long, 90° hook.



08023002

Hand Hole Hooks

The Hand Hole Hook from Condux allows you to easily unlock then hook and pull up to open the Hand Hole. Save time and effort on the job with the Hand Hole Hook from Condux. Length is 26 3/4".

Part Number	Description
08023012	Hand Hole Hook, no Socket
08023010	Hand Hole Hook with Socket
02290772	7/8" Hex/Penta Socket (1 pc - Reversible)



7/8" Hex Socket 7/8" Penta Socket

02290772

Hand Hole Hook with 1/2" Drive

Hand Hole Hook with 7/8" Hex Socket

Hand Hole Hook with 7/8" Penta Socket

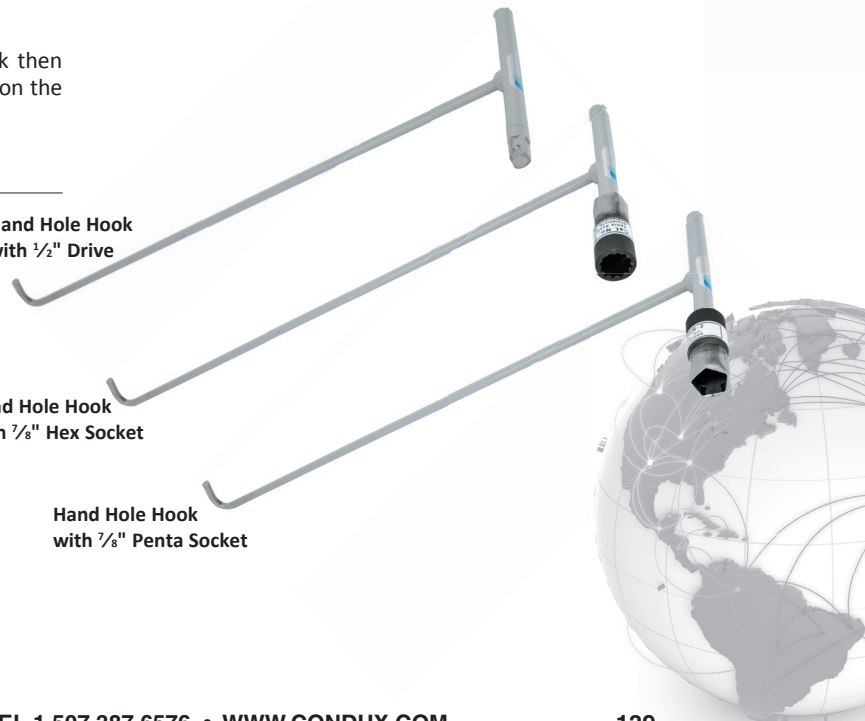



DUCT PLUGS



Fiber Optic Innerduct Plug

Split plug with bushing assembly for sealing around cable in duct installations. Simple installation around in-place cables, seal all types of innerduct, ideal for manholes, buildings and cabinets.

Part Number	Size (in)	Conduit I.D. Range		Cable O.D. Range	
		(in)	(mm)	(in)	(mm)
08043960	1	1.05-1.13	27-29	.35-.57	9-14
08043961	1	1.05-1.13	27-29	.51-.71	13-18
08043962	1 ¹ / ₄	1.28-1.36	33-35	.35-.57	9-14
08043963	1 ¹ / ₄	1.28-1.36	33-35	.51-.71	13-18
08043964	1 ¹ / ₄	1.28-1.36	33-35	.71-.84	18-21
08043965	1 ¹ / ₂	1.46-1.56	37-40	.35-.57	9-14
08043966	1 ¹ / ₂	1.46-1.56	37-40	.51-.71	13-18
08043968	2	1.92-2.06	49-52	.25-.51	6-13
08043969	2	1.92-2.06	49-52	.52-.75	13-19

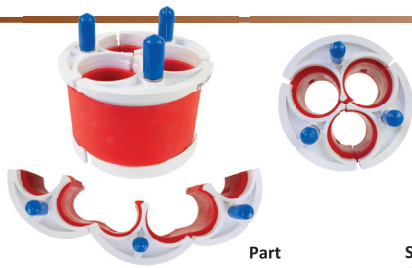

Innerduct Organizer Plug

Removable and reusable duct seal holds innerduct securely and prevents migration. Easy installation requires no foam or chemicals.

Part Number	Size (in)	Conduit I.D. Range		Maximum number of Innerduct	Innerduct Size (in)	Innerduct O.D. Range	
		(in)	(mm)			(in)	(mm)
08093402	4	3.95-4.15	100-105	3	1 & 1 ¹ / ₈	1.38-1.42	35-36
08093404	4	3.95-4.15	100-105	3	1 ¹ / ₈ & 1 ¹ / ₄	1.63-1.67	41-42

Non-Metallic Eye Nut Plug

Made of durable, expansive polyurethane with rugged polypropylene compression plates and eye nut. No tools required for installation. Completely water and air tight. Max air pressure 20 psi.



Part Number	Size (in)	Conduit I.D. Range	
		(in)	(mm)
08067825	2 ¹ / ₂	2.30-2.99	58-76
08067830	3	2.92-3.45	74-88
08067840	4	3.94-4.33	100-110
08067850	5	4.85-5.25	123-133
08067860	6	5.98-6.38	152-162

Universal Plug

For temporarily plugging duct, bell-ends and terminators. These polyethylene plugs come in sizes to fit all types of manufactured duct, even when the duct is bell-ended or a coupling is attached. The Universal Plug's extended lip design permits easy extraction.



Taper of Universal Plugs

Part Number	Size (in)	Conduit I.D. Range	
		(in)	(mm)
08047400	2	1.53-2.69	39-68
08047500	3	2.61-4.01	66-102
08047601	4	3.78-5.35	96-136
08047700	5	4.50-6.13	114-156
08047800	6	5.56-7.00	141-178

Innerduct Plug

Sold individually and in boxes of 50.



Part Number	Nominal Duct Size (in)	Conduit I.D. Range	
		(in)	(mm)
08067811	1	0.99-1.39	25-35
08067812	1 ¹ / ₄	1.16-1.51	29-38
08067814	1 ¹ / ₂	1.46-1.83	37-46
08067820	2	1.83-2.39	46-61



CONDUX

QUICKTENT



OTHER PRODUCTS

The Condux QuickTent

The Condux QuickTent is a portable, freestanding work shelter suitable for use in all kinds of weather conditions. Designed for one person to set up in a matter of seconds, the Condux QuickTent features a fiberglass frame and urethane coated nylon cover that will provide years of dependable service. The QuickTent comes in five sizes, each of which provides a roomy working environment, and folds down to fit into a small, lightweight carrying bag which is sewn into the tent. Other features include:

- Roll-up door with velcro or zipper closures
- Window / vent with closing flap
- Exhaust port
- 12" (305 mm) skirt around the base
- Built-in wind lines for tethering



Easy set-up



Part Number	Description	Dimensions (Set Up) ft (m)	Dimensions (Packed) ft (m)	Weight lbs (kg)	Door Size ft (m)	Window/Vent Size in (mm)	Exhaust Port Diameter in (mm)
08672400	4x4 tent w/ velcro door	4 x 4 x 6.5 (1.2 x 1.2 x 2)	8 x 48 (203 x 1,219)	24 (11)	3 (.9)	12 x 36 (305 x 914)	10 (254)
08672500 08672510	6 x 6 tent w/ velcro door 6 x 6 tent w/ zipper door	6 x 6 x 6.5 (1.8 x 1.8 x 2)	8 x 69 (203 x 1,753)	32 (15)	4 (1.2)	12 x 36 (305 x 914)	10 (254)
08672600 08672520 08672525	8 x 8 tent w/ velcro door 8 x 8 tent w/ zipper door 8 x 8 tent 1 slit door w/ zippers	8 x 8 x 7.5 (2.4 x 2.4 x 2.4)	8 x 95 (203 x 2,413)	40 (18)	4 (1.2)	12 x 36 (305 x 914)	10 (254)
08672700	10 x 10 tent w/ velcro door	10 x 10 x 8 (3 x 3 x 2.4)	9 x 96 (228 x 2,436)	63 (28)	4 (1.2)	12 x 36 (305 x 914)	10 (254)
08672720	10 x 12 tent w/ velcro door	10 x 12 x 8 (3 x 3.6 x 2.4)	9 x 96 (228 x 2,436)	70 (31)	4 (1.2)	12 x 36 (305 x 914)	10 (254)





MANHOLE EQUIPMENT & ACCESSORIES

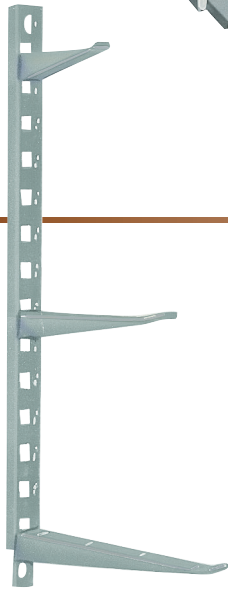
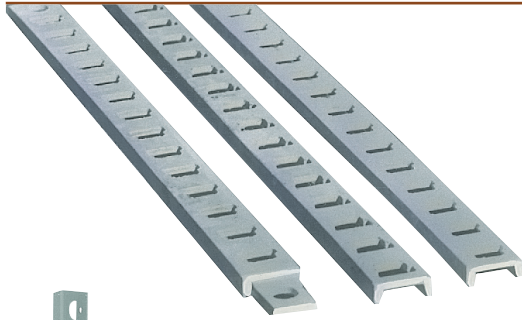

Cable Racks

Supports cable runs in manholes and vaults. Made of 1½" x 9/16" x 3/16" (38 x 14 x 5 mm) hot rolled steel channel, hot dip galvanized. T-slots for attaching hooks are spaced at 1½" (38 mm) intervals. The 8, 14 and 18 hole racks have 19/32" x 3/4" (15 x 19 mm) mounting slots at each end that interlock so two or more racks may be combined into one unit. Longer racks are mounted through the T-slots. Use ½" or M12 mounting hardware (see pg. 143).

Part Number	Support Holes	Length		Bolt Hole Spacing	
		(in)	(mm)	(in)	(mm)
08380000	8	15	381	13½	343
08380100	14	24	610	22½	572
08380200	18	30	762	28½	724
08380300	37	55¼	1,403	-	-
08380400	43	64¼	1,631	-	-
08383500	47	70¼	1,784	-	-

Cable Rack Hooks

Designed to fit snugly into the rack slots. Turned up ends prevent cable or rack insulators from slipping off. Manufactured from 3/16" (5 mm) steel and hot dip galvanized with smooth surfaces to prevent cable damage. Cable rack hooks load rated to 300 lbs.

Part Number	Ext.	
	(in)	(mm)
08380600	4	102
08380700	7½	190
08380800	10	254
08380900	14	356
08381000	18	457

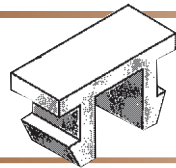

Plastic Retaining Clip

Part Number	Description
08381210	Plastic Retaining Clip

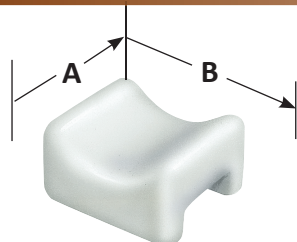

Cable Rack Insulator

Made of glazed porcelain, the insulators rest on the cable rack hooks, providing additional protection for the cable.

Part Number	Groove Radius		Groove (A) Width		Groove (B) Width	
	(in)	(mm)	(in)	(mm)	(in)	(mm)
08381200	1½	38	2¾	70	3	76

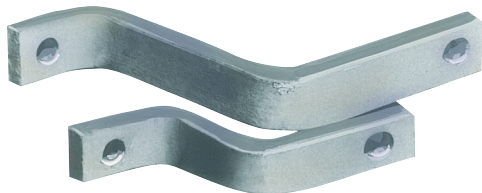

Cable Rack Support

To extend the racks away from the wall and avoid obstructions or water seepage. Each rack requires two supports. Hot dip galvanized. Use ½" or M12 mounting hardware (see pg. 143).

Part Number	Steel Size		Ext. from wall	
	(in)	(mm)	(in)	(mm)
08381500	.5 x 1.00	13 x 25	3⅞	89
08383900	.5 x 1.00	13 x 25	6⅞	165
08383800	.5 x 1.25	13 x 32	6⅞	165



Corner Rack Support

To bolt the racks at manhole corners. Mounting bolt holes for ½" or M12 bolts (see pg. 143). Formed of 1½" x ¼" (38 x 6 mm) steel and hot dip galvanized.

Part Number	Description
08383700	9" x 12" (228 x 305 mm) legs
08383600	12" x 12" (305 x 305 mm) legs



MANHOLE EQUIPMENT & ACCESSORIES



OTHER PRODUCTS

Manhole Ladders—Wall Mount

All ladders are manufactured of steel. The rungs pass through the side rails and are riveted or welded.

Features:

- 5/8" (16 mm) diameter deformed rungs on 12" (305 mm) centers
- 14" (356 mm) clear between side rails
- 2 x 1 x 1/8" (51 x 25 x 3 mm) channel side rails
- Furnished with 4 unattached floor/ceiling brackets
- Wall mounting brackets may be used (sold separately)
- Approx. weight is 5.5 lbs. (2.5 kg) per foot of length

Part Number	Description
08382001	Manhole Ladder, wall mount, 7.0' (2.1 m) long
08382101	Manhole Ladder, wall mount, 8.0' (2.4 m) long
08382301	Manhole Ladder, wall mount, 10.0' (3.0 m) long
08382501	Manhole Ladder, wall mount, 12.0' (3.7 m) long
08382701	Manhole Ladder, wall mount, 14.0' (4.3 m) long
08382901	Manhole Ladder, wall mount, 16.0' (4.9 m) long
08384101	Manhole Ladder, wall mount, 18.0' (5.5 m) long
08384201	Manhole Ladder, wall mount, 20.0' (6.1 m) long

Optional Wall Brackets

Part Number	Description
08382902	7" (178 mm) offset

Manhole Ladders

All ladders are manufactured of steel. The rungs pass through the side rails and are riveted or welded. The unique design assures a rung cannot turn.



Features:

- 5/8" (16 mm) diameter knurled rungs on 12" (305 mm) centers
- 12" (305 mm) clear between side rails
- 3/8 x 1 1/2" (10 x 38 mm) side rails, through 12' (3.7 m) lengths
- 3/8 x 2 1/2" (10 x 64 mm) side rails, 13' (4.0 m) length and above
- Twisted hook is integral part of side rail
- Approx. weight is 5 lbs. (2.3 kg) per foot of length, through 12' (3.7 m)
- Approx. weight is 7.6 lbs. (3.4 kg) per foot of length, over 12' (3.7 m)

Part Number	Description
08381955	Manhole Ladder, 5.5' (1.7 m) long
08382100	Manhole Ladder, 8.0' (2.4 m) long
08382300	Manhole Ladder, 10.0' (3.0 m) long
08382500	Manhole Ladder, 12.0' (3.7 m) long
08382700	Manhole Ladder, 14.0' (4.3 m) long
08382900	Manhole Ladder, 16.0' (4.9 m) long
08384200	Manhole Ladder, 20.0' (6.1 m) long

Ladders are hot dip galvanized. Rated at 300 lbs (136 kg).

Pulling-In Irons

Set into the walls of the concrete manholes opposite all duct entrances to provide a strong, convenient attachment for pulling-in blocks when installing or removing cables. Manufactured with 7/8" (22 mm) diameter steel and hot dip galvanized. 40,000 lbs load rating.

Part Number	Description
08383002	9" (228 mm) w/opposing bends
08381301	12" (305 mm) w/cross bar & retaining plate
08381302	12" (305 mm) w/opposing bends



ORDER CAREFULLY!
This item is made-to-order and is not returnable.

Expansion Anchor

For use in pre-drilled holes. Plug expands as anchor is driven into it making a solid hold in concrete.

Part Number	Description	Allowable Working Loads*			
		Tension		Shear	
		(lbs)	(N)	(lbs)	(N)
08409900	3/4"- 10 UNC Threads	4,010	17,836	4,400	19,571
08409901	5/8"- 11 UNC Threads	2,420	10,764	3,050	13,566
08409902	1/2"- 13 UNC Threads	1,690	7,517	1,560	6,939

*NOTE: Allowable working loads are in 4000 psi concrete.

Allowable shear loads are based on the use of SAE Grade 5 capscrews.



Mounting Hardware

Part Number	Description
02063303	Capscrew, 1/2-13 x 1.25", grade 5, hot galvanized
12008202	Capscrew, 1/2-13 x 1.50", grade 5, hot galvanized
12022003	Capscrew, 1/2-13 x 1.75", grade 2, hot galvanized
08384800	Capscrew, 1/2-13 x 2.00", grade 5, hot galvanized
02155703	Capscrew, 1/2-13 x 2.50", grade 2, hot galvanized
02010003	Lockwasher, 1/2", hot galvanized
12008303	Flatwasher, 1/2", hot galvanized
02125103	Hex Nut, 1/2-13, hot galvanized

